

digital

1974
FIELD SERVICE
TECHNICAL MANUAL

CONFIDENTIAL

digital

**1974
FIELD SERVICE
TECHNICAL MANUAL**

CONFIDENTIAL

Copyright © 1974 by Digital Equipment Corporation

The material in this manual is for informational purposes and is subject to change without notice.

Digital Equipment Corporation assumes no responsibility for any errors which may appear in this manual.

Printed in U.S.A.

CONFIDENTIAL

This manual is printed for the express use of Field Service Engineers employed by Digital Equipment, is proprietary in nature and is not to be used or disclosed outside of Digital Equipment Corporation.

The following are trademarks of Digital Equipment Corporation, Maynard, Massachusetts:

DEC	PDP
FLIP CHIP	FOCAL
DIGITAL	COMPUTER LAB

TABLE OF CONTENTS

	PAGE
FIELD SERVICE TECH TIP PROCEDURE	1
CHAPTER 1 INTRODUCTION	1
CHAPTER 2 ORIGINATION, REVIEW, & APPROVAL	3
CHAPTER 3 TECH TIPS FORMS AND FORMAT	7
12 BIT AND CROSS PRODUCT LINE TECH TIPS	9

FIELD SERVICE TECH TIP PROCEDURE

CHAPTER 1 INTRODUCTION

1.1 PURPOSE

The purpose of this procedure is to ensure that all field service technical manuals (tech tips) conform to one format with complete and accurate information. This procedure is divided into three chapters designed to generate, process, and implement tech tips with the workload being distributed at all levels of involvement.

1.2 CRITERIA

Types of information to be included in a tech tip:

- Nice to know information
- Helpful troubleshooting techniques
- Safety precautions
- Possible problem areas and solution
- Information not releasable to customers
- Preliminary PM'S
- Significant ECO errors
- Unique product information
- Pertinent vendor information

CHAPTER 2
ORIGINATION, REVIEW, AND APPROVAL

2.1 ORIGINATOR

1. Anyone in Field Service can generate a tech tip. Refer to Chapter 3 for Tech Tip Forms and Format.
2. Field - Tech Tips generated in the field will be submitted to the Regional Product Support Supervisor for review.
3. In-House, Depot, & Product Support---Tech Tips generated at the corporate level will be sent to Product Support for review. CPL Tech Tips presently will be coordinated by 8 Product Support.

2.2 REVIEW AND COORDINATION

1. The review cycle for a Tech Tip will be as described in figure 1. The author should receive notification of approval or disapproval within 30 days of the date of submission. Complete cycle equals 60 days.

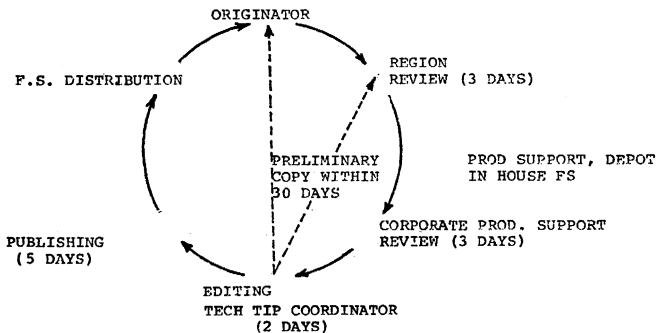

Figure 1. Tech Tip Reviewing Cycle

2. The Regional Product Support Supervisor will be the reviewing authority for Tech Tips generated in the field. It will be his responsibility to:
 - a. Assign each Tech Tip to an individual familiar with the option for checking its authenticity and format.
 - b. If disapproved notify the author in writing within 3 working days of date it was received.
 - c. If approved, forward the Tech Tip master to corporate product support within 3 working days. Tech Tips received from each region will be considered ready for publication although they will still be reviewed at the corporate level.
3. At the corporate level there will be assigned a Tech Tip Coordinator for the 12, 16, 18, or 36 bit processors. He or she will be responsible:
 - a. To assign the Tech Tip to the product support representative most familiar with the option for review.
 - b. To maintain a suspense file when the review on each Tech Tip is to be completed. (3 days after receipt).
 - c. To notify the author and each region when a Tech Tip has been approved or disapproved within 30 days of the date originated. Approvals will be a copy of the Tech Tip marked "PRELIMINARY".
 - d. To assign approved Tech Tips a sequential number and arrange the Tech Tips in an economical production MASTER to be published. Blank Text Headers can be obtained for this purpose on DEC FORM 12-(74N)-1191-N374. Specify "Crack and Peel" in paper block on printing requisition.
 - e. To see to it that the Tech Tip is published.
 - f. To maintain a log of each Tech Tip by job number to know where that Tech Tip is at all times.
4. CPL Tech Tips presently will be coordinated by 8 Product Support. Upon receipt of a CPL Tech Tip, the 12 bit Tech Tip Coordinator will distribute a copy to each Product Market Support Manager (or their Tech Tip Representative) who is concerned with that option. It will in turn be their responsibility to have one of their personnel review the Tech Tip as pertaining to their group and return the copy to the 12 Bit Coordinator by the suspense date of 3 days. Notification by telephone will be sufficient for approval; if no reply is received by the

suspense date the Tech Tip Coordinator will initiate action to obtain approval or disapproval. CPL Tech Tips will then be assigned a number by the 12 Bit Coordinator when all copies have been returned approved. Notification will then be provided to the author and the Tech Tip sent to publication. A simple "N/A" will indicate not applicable to that Family. Any disapprovals will be accompanied by the reason.

2.3 CORPORATE APPROVAL

The Corporate Product Support Engineer to whom the Tech Tip is assigned for review will be responsible to:

1. Ensure that the Tech Tip meets the criteria as established by this procedure.
2. Ensure that no other Tech Tip exists which contains similar information.
3. Review the Tech Tip for Technical Accuracy and thoroughness of information.
4. If approved, type name & date in space provided and forward the Tech Tip Master to the respective 12,16,18, or 36 bit Tech Tip Coordinator.
5. If disapproved, notify the author, corporate tech tip coordinator and if submitted from the field, the regional support supervisor, in writing, the reason (s) for disapproval.
6. Review the effect any part or kit called out in a Tech Tip will have on Logistics, which includes:
 - a. Ensuring that the part is orderable by that part number and appears on the mini-parts List.
 - b. Notifying the principal field service engineer responsible for the Recommended Spares Level on that option.
 - c. Reviewing the population report to estimate the initial requests for that part from the field and submit that estimate to Logistics - Inventory Control. He may in turn prepare a forecast for that part and avoid unnecessary Pl's.
 - d. Notifying the Technical Documentation-IPB department to ensure any change in maintenance philosophy, non field repairable items (NFR) or kit is reflected in the IPB.
 - e. Notifying the Tech Tip Coordinator when the above actions have been completed prior to publication of the Tech Tip.

				FIELD SERVICE TECHNICAL MANUAL		Option or Designator	
12 Bit <input checked="" type="checkbox"/>		16 Bit <input type="checkbox"/>		18 Bit <input type="checkbox"/>		36 Bit <input type="checkbox"/>	
Title						Tech Tip Number	
Processor Applicability		Author		Rev		Cross Reference	
All	<input type="checkbox"/>	<input type="checkbox"/>	<input type="checkbox"/>	<input type="checkbox"/>	<input type="checkbox"/>	<input type="checkbox"/>	<input type="checkbox"/>
Approval		Date					
PAGE		PAGE REVISION		PUBLICATION DATE			

DEC 12-1740-1189-A374

FIGURE 2. FIELD SERVICE TECHNICAL MANUAL
FRONT PAGE 8½" X 11"

Title			Tech Tip Number				
Processor Applicability		Author		Rev		Cross Reference	
All	<input type="checkbox"/>	<input type="checkbox"/>	<input type="checkbox"/>	<input type="checkbox"/>	<input type="checkbox"/>	<input type="checkbox"/>	<input type="checkbox"/>
Approval		Date					
PAGE							

DEC 12-1740-1189-A374

FIGURE 3. FIELD SERVICE TECHNICAL MANUAL
CONTINUATION SHEET 8½" X 11"

CHAPTER 3
GENERATING TECH TIPS

3.1 TECH TIP FORMS

1. Tech tips will initially be typed on Form No. DEC 12-(74N)-1189-N374. (see figure 2) All odd pages in the tech tip manual will also be typed on this form.
2. All continuation sheets will initially use Form No. DEC 12-(74N)-1190-N374. (see figure 3) All even pages in the tech tip manual will also be typed on this form.
3. Forms can be ordered on a printing requisition DEC 5-(550)-1023C-R672) through: DIGITAL EQUIP. CORP. OFFICE-SERVICES - FORMS CONTROL, MAYNARD, MASS. A minimum of 500 copies will be accepted.
4. The following pages explain the page header (blocks 1 and 2), text header (blocks 3 - 10) and Publication Block and CPL area (block 11 - 14), (see figure 2).
5. Explanation of Blocks in figure 2 and 3 and individual responsible to fill in that block.
 1. The boxes in this area define the distribution of the respective pages to those persons who are holders of that respective manual; i.e., if 12 bit were checked the tech tip would be distributed to 12 bit tech tip manual holders; if 12 bit and 16 bit were checked, the page would be distributed to 12 and 16 bit manual holders. This area will be filled in by the TECH TIP COORDINATOR.
 2. This block will contain a designator that corresponds as closely to Digital's Option Designation List as possible. Occasionally, it will be necessary to use module numbers or system types, etc. All information on a specific page will pertain to the option or device indicated in this block. This area is filled by the author.
 3. This block is an explicit, comprehensive title. This area is filled by the author.
 4. The number in this box designates the sequential entry of text pertaining to the device. This area is filled by the Tech Tip Coordinator.
 5. This blank is used to designate the processor type the tech tip relates to; i.e. all 8's; 11/05; 10. This blank is filled by the author or anyone in the reviewing cycle.

5. This blank is used to designate the processor type the tech tip relates to; i.e. all 8's; 11/05; 10. This blank is filled by the author or anyone in the reviewing cycle.
6. This blank gives the authors name and cost center. This is filled in by the author.
7. This block gives the revision level of the entry. This block is filled by the Tech Tip Coordinator.
8. The reviewing Product Support Engineer fills this slot. This block is filled by the Product Support Engineer.
9. The date of approval is inserted here by the Reviewing Engineer.
10. This blank allows additional information to be expressed about a device and/or eliminate the need for duplicating information. The blank is filled as needed by author or anyone in the tech tip reviewing cycle.
11. CPL is typed in this area if the device is on a CPL device. This is typed by the author or anyone in the reviewing cycle.
12. This page expresses the number of pages per designator not pages per manual. This is filled in by the Tech Tip Coordinator.
13. This block states the revision of the page. This block is filled by the Tech Tip Coordinator.
14. This is the date the page is issued to publication. This blank is filled by the Tech Tip Coordinator.

3.2 FORMAT

1. When a tech tip is generated to resolve a problem, the problem will be explained first, then the solution.
2. All information will be typed and in paragraph form.
3. Paragraph separation will be double spaced.
4. All illustrations will be of production quality and drawn in black ink (ball point); use of straight edge, template, or compass is recommended.
5. Ensure that all information is complete but concise.

3.3 SUSPENSE FILE

It is recommended that the author or the office/section/group keep a file of tech tips submitted for publication. This will make it easier to resubmit lost tech tips rather than rewriting them. Tech tips for which you have not received notification of approval or disapproval within 30 days should be resubmitted along with a cover letter stating that it is a resubmission.

digital	FIELD SERVICE TECHNICAL MANUAL				Option or Designator
	12 Bit <input checked="" type="checkbox"/>	16 Bit <input type="checkbox"/>	18 Bit <input type="checkbox"/>	36 Bit <input type="checkbox"/>	183/184

Title WIRING ERRORS FOUND WHEN ADDING 183/184 to A LINC-8				Tech Tip Number 183/184-TT-1	
All	Processor Applicability			Author H. Long	
				Rev 0	
			Date 09/14/72		Cross Reference

Problem: Common wiring errors found when adding 183/184 to a Linc-8.

Many times after completing the installation of the extended memory to the Linc-8 it has been found that some problems still exist. Problems such as trying to run LAP-6 and even the St. Louis test in upper core have been adding many hours to the installation time. These problems have not actually been the fault of the 183/184 but of the PDP-8 processor there have been some common wiring errors in some of the older Linc-8's. These wiring errors apparently cannot be picked up by

Solution: This revision will list these wiring errors and also give general areas to keep in mind when such a problem develops.

<u>Print</u>	<u>From</u>	<u>To</u>	<u>Delete</u>	<u>ADD</u>	<u>ADD</u>
S-BS-Linc-8-0-P105	PC18F	PD19H	X		(p.62)
D-BS-Linc-8-0-P105	PD18H	GND	X		(p.62)
D-BS-Linc-8-0-P109	PC31J	PC31L	X		(p.65)
D-BS-Linc-8-0-P109	PC31J	PC31L		X	(p.65)
D-BS-Linc-8-0-L18	LB01F	LH06L		X	
D-BS-Linc-8-0-L18	LB06N	LH18J		X	

There are wiring errors that have been found in the field so far. There may be others in the same runs or in different runs. It would be a good idea to keep an eye on the MB register and control page for other errors. This seems to be the area where most of the problems occur. Low MB-1 run has also been found to have errors in it.

/mt

Title					Tech Tip Number	
183/184 EXTENDED MEMORY INSTALLATION					183/184 TT#7	
All		Processor Applicability		Author	Rev	Cross Reference
				W. Freeman	Ø	
8				Approval	Date	
				W. Cummins	11/15/73	

STEP	ITEM	FROM	SIGNAL	TO	SIGNAL
1	add	cable	184 C/D 25	S.A. Ø-7	ME31 S.A. Ø-7
2	add	cable	184 C/D 26	S.A. 8-11	MF31 S.A. 8-11
3	add	cable	184 C/D 27	S.F. 1-7	ME33 S.F. 1-7
4	add	cable	184 C/D 28	BMA Ø-4	ME32 BMA Ø-4
5	add	cable	184 C/D 29	BMA 4-8	MF32 BMA 4-8
6	add	cable	184 C/D 30	BMA 9-11	MF33 BMA 9-11
7	add	cable	184 C/D 31	BMB Ø-5	ME35 BMB Ø-5
8	add	cable	184 C/D 32	BMB 6-11	MF35 BMB 6-11
9	add	cable	MD35	Int. Ack./ MB → PC	PDØ2 Int. Ack./ MB → PC
*10	delete	jumper	PDØ2U	Int. Inh.	PDØ3C ground (red)
11	delete	jumper	MC19E	Mem. Start	MF36E Mem. Start
12	add	jumper	MF36E	Mem. Start	MA32D Mem. Start
*13	add	jumper	MA32F	Start Field Ø	MC19E Mem. Start
14	delete	wire	MA32D	Mem. Start	MA32F Start Field Ø
15	add	wire	MF1F	R111 node	MF1V Clamp load
16	add	wire	EMC19E Start Field (print 184-02 grid D1)	Start Field in 184 (print 184-02 grid D8) if field 1 - EMC/D27D if field 2 - EMC/D27E if field 3 - EMC/D27H if field 4 - EMC/D27K if field 5 - EMC/D27M if field 6 - EMC/D27P if field 7 - EMC/D27S	
17	add	yellow wire	PDP8 Read/Write plus	Tab of G802-184-C/DØ1 (Print 184-0-2-ref C6)	
18	add	D003	MF02U print 183-0-3 grid B8	MF02V (Cathode) Parallels another D003	
19	delete	100 ohm resistor	on each W024 at PD2 and MD35 - pins A and B	print 183-0-3 grid A1	
20	add	10 ohm resistor		on each W024 at PD2 and MD35 - pins A and B	
21	add	6 bulbs		IF & DF	

NOTE: It is not readily apparent from the prints that a signal, which is Word Count (1) and W.C. SET, is generated (print 8P-0-6, grid C5) to force field Ø for a 3 cycle break (print 183-0-3, grid D8)

* Note print error-MDØ2P (int. inhibit flip flop) is connected to MD35U not MB35U.

* MC19E, MA32F (start field Ø), ME17T, MD16K and MC16D must be interconnected.

digital	FIELD SERVICE TECHNICAL MANUAL				Option or Designator
	12 Bit <input checked="" type="checkbox"/>	16 Bit <input type="checkbox"/>	18 Bit <input type="checkbox"/>	36 Bit <input type="checkbox"/>	183/184 to 580

Title EXTENDED MEMORY PROBLEM WITH ECO #117					Tech Tip Number 183/184-TT-3	
All		Processor Applicability		Author Bill Freeman	Rev β	Cross Reference
	8			Approval W. Cummins	Date 12/05/73	

PROBLEM: Machines with Extended Memory will not run with ECO #117 installed. This ECO adds a clamp load to Pin F of MF1. Removing the clamp load seems to cure the problems.

SOLUTION: Removing the clamp load is not the proper solution. The purpose of the clamp load is to improve the gate drive capability of MF1. The clamp therefore should stay.

The real problem lies in the cable which supplies B Set, Fetch and Defer to the 183 Control.

The W024 paddle boards at PF1, PF36, PD2, and MD35 have 100 ohm resistors in series with Pins A & B. These resistors should be changed to 10 ohms.

Title NO MB SHIFT WHEN INSTALLING 189					Tech Tip Number 189-TT-1	
All		Processor Applicability		Author Bill Freeman	Rev β	Cross Reference
	8			Approval W. Cummins	Date 12/05/73	

Problem: No. MBO Shift Enable Level when 189 is installed without a 681.

Solution: The gate which generates MBO Shift Enable is located in the 681 data line interface logic. When a 189 is installed without a 681, then the following jumper must be installed:

PE5R to PE5V
PE5S to PE5U

Title 552 DECTAPE INSTRUCTION MANUAL						Tech Tip Number 552-TT#1		
All	Processor Applicability					Author W. Freeman	Rev 0	Cross Reference
	5	8				Approval W. E. Cummins	Date 12/11/73	

There are several errors in the timing set-up procedure in the 552 Dectape Instruction Manual: (Errors 1 through 4 will be found only in the Instruction Manual, the prints are correct.)

- 1) On page 5-6, step b, the negative duration of the signal should be shown to be 140 Msec, not 35 Msec.
- 2) Page 5-6, step c, the point to scope is 2214T, not 2L14P, also the negative duration of the signal should be shown to be 140Msec, not 35Msec.
- 3) Page 5-6 step d, the negative duration of the signal should be shown to be 90 Msec, not 35Msec.
- 4) Page 5-7, step i, the point to scope is 2L08T, not 2L08P.
- 5) Both the manual (step k, page 5-7) and print BS-D-552-D-7 indicate incorrect signal duration: a duration of 3 Usec should have been specified. (2L08Z)

Title MAINDEC 831-5/8 DECTAPE MAINTENANCE PACKAGE						Tech Tip Number 552-TT#2		
All	Processor Applicability					Author W. Freeman	Rev 0	Cross Reference
	5	8				Approval W. E. Cummins	Date 12/12/73	

The timing routine in Maindec 831 will not run with a 183 extra memory control. When Mac Ext. 2 in the Mac Register is set, the program fails by wiping out the program. This is a program fault, not a hardware problem.

Title PROCEDURE FOR SETTING DELAYS IN PDP-8 580 MAG TAPE CONTROL						Tech Tip Number 580-TT-1		
All 8's	Processor Applicability					Author W. Freeman	Rev 0	Cross Reference
						Approval W. Cummins	Date 06/06/72	

Use with MAINDEC-827 (580 compiler). For the BOR delay write the tape at the correct density and check timing, then read the written portion for the read check. For the motion delays write a section of tape and check timing, then check read backward timing and finally, read forward timing.

Delay | Function | Program | Operation | Sync | Look at | Duration |

The following delays are shown on print BS-D-580-0-7 (sheet 3 of 3).

D1	200 BPI Clock	ST:100 WR: JM:1	Writing 200 BPI	-	1M7H	111 usec
D2	556 BPI Clock	ST:110 WR: JM:1	Writing 556 BPI	-	1M7H	40 usec

digital	FIELD SERVICE TECHNICAL MANUAL				Option or Designator
	12 Bit <input checked="" type="checkbox"/>	16 Bit <input type="checkbox"/>	18 Bit <input type="checkbox"/>	36 Bit <input type="checkbox"/>	552 to 680

Title 580 DELAY SET UP (Continued)					Tech Tip Number 580-TT-1	
All 8's	Processor Applicability		Author W. Freeman	Rev 0	Cross Reference	
			Approval W. Cummins	Date 06/06/72		

The following delays are shown on print BS-D-580-0-7 (sheet 2 of 3).

Delay	Function	Program	Operation	Sync	Look at	Duration
D3	Write EOR 556 BPI	RE: ST:110 GO: WR:1 3000 JM:3	Write one word record 556 BPI	1M2K	1M6S	160 usec
D4	Read EOR 556 BPI	RE: ST:110 RD:1 3000 JM:2	Read one word record 556 BPI	1N7K (2nd pulse)	1M6S	120 usec
D5	Write EOR 200 BPI	RE: ST:100 GO: WR:1 3000 JM:3	Write one word record 200 BPI	1M2K	1M6S	444 usec
D6	Read EOR 200 BPI	RE: ST:100 RD:1 3000 JM:2	Read one word record 200 BPI	1N7K (2nd pulse)	1M6S	340 usec
D7 ^{*A}	Write from load point	GO: WR:1 3000 JM:2	Write one word record from load point	1N16R (GO going to a one)	1M6V	120 msec
D8	Write from load point	RE: GO: WR:1 3000 JM:2	Write one word record	1N16R (GO going to a one)	1M6V	10.4 msec
D9	Read Forward Stop	RE: RD:1 3000 JM:1	Read one word record	1M6S	1M6V	3.2 msec
D10	Read reverse Stop	RB:1 3000 JM:1	Read back- wards one word record	1M6S	1M6V	6.5 msec
D11 ^{*A}	Read from load point	RD:1 3000 JM:1	Read from load point	1M10F (10T 6704)	1M6V	90 msec
D12	Read Start and NOP	RE: RD:1 3000 JM:1	Read one word record	1M10F (10T 6704)	1M6V	4.3 msec

The following delay is shown on print BS-D-580-0-6 (sheet 2 of 2).

SKW ^{*B}	Skew	RD: JM:	Read a record	-	1N2W	15 usec.

NOTES:

*A To check timing from load point rewind the tape in local, then ground 1M3Y and check write timing. For read timing, unground 1M3Y, rewind, reground and read the tape just written.

*B For the skew delay, write a length of tape and then read this portion of tape.

Title					Tech Tip	
680/PDP8 MEMORY ALTERATIONS					Number	
					680 TT#1	
All			Processor Applicability		Author W. Freeman	
					Rev 0	
			Approval		Date	
			W. F. Cummins		11/13/73	
					Cross Reference	

Several incidents of intermittent PDP8/680 program alterations have been caused by multiple skips which occurred during the "TT SERVICE SUBROUTINES". The intermittent, but erroneous, skips were traced to the S603 in the processor at PB21 which generates COUNT PC ENABLE.

To demonstrate the problem, the following program may be run while varying the -15 volt margins on racks PB and PC.

0200 / 6402	TTI	0204 / 7402	HLT
0201 / 0000	LSW	0205 / 7402	HLT
0202 / 7402	CAW	0206 / 7402	HLT
0203 / JMP200	JMP to TTI	0207 / 7402	HLT
		0210 / 7402	HLT

The instruction 6402 generates the required skips as well as the occasional extra skips. The contents of the LSW are normal for TTI but the contents of CAW (7402) and the halts in 0204 and 0205 are to demonstrate that the extra skips do occur. The jump 0200 is to make the routine repetitive until the extra skip does occur. To watch the extra skip pulses on the scope, connect a scope probe to PB21, pin T. Remove the halts from the program and substitute JMP 0200's. Vary the -15 volt processor wing margins on racks B and C.

If the 680 has an S603 which is causing the problem the following general wave shapes may be seen:

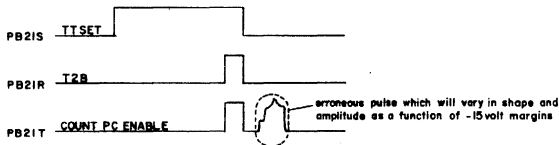

An engineering evaluation of this problem has resulted in the following formalized solution which will be incorporated in an ECO which will be released soon.

DELETE: PC04D to PB21T
PB21T to PD22V

ADD: PC04D to PD22V
PB21T to PD22U
PC28P to PC28M

digital	FIELD SERVICE TECHNICAL MANUAL				Option or Designator
	12 Bit <input checked="" type="checkbox"/>	16 Bit <input type="checkbox"/>	18 Bit <input type="checkbox"/>	36 Bit <input checked="" type="checkbox"/>	680 to 708

Title					Tech Tip	
W750 JUMPERS & REVISIONS					Number 680 TT#2	
All		Processor Applicability		Author W. Freeman		Rev 0
				Approval W. E. Cummins		Date 11/13/73
					Cross Reference	
					W750 TT#1	

Title					Tech Tip	
681 JUMPERS					Number 680 TT#3	
All		Processor Applicability		Author W. Freeman		Rev 0
				Approval W. E. Cummins		Date 11/13/73
					Cross Reference	
					681TT#1	

Title					Tech Tip	
ERRORS WITH Maindec-08-D72A					Number 680-TT#4	
All		Processor Applicability		Author Bill Freeman		Rev 0
8				Approval W. Cummins		Date 12/05/73
					Cross Reference	

PROBLEM: Encountering false errors with 680 DCS Data & Control Test MainDEC -08-D72A when running program in a 685 and 683 configuration of a 680 system in the error check mode.

SOLUTION: Eliminate error checking and scope each input and output for proper operation. The 683 can also be disconnected and the W750's in 685 jumpered input to output. This will allow checking of 685 with program in error check mode. The false errors are from the program not taking into account delays of the relays switching.

Title					Tech Tip	
681 Jumpers					Number 681-TT-1	
All		Processor Applicability		Author W. Freeman		Rev 0
8				Approval W. Cummins		Date 11/15/73
					Cross Reference	

Whenever a 681 Data Line Interface is installed without a 189 A/D option, verify/install the following:

PE15M (R603) to ground
 PE5 R (R123) to ground
 PE5 S (R123) to ground

Installation of these jumpers will eliminate the possibility of spurious MB Shift Enable levels or spurious Restart Sync pulses generated by system or environmental noise.

Title 689 DATA SET CABLE						Tech Tip Number 689-TT-1		
All	Processor Applicability					Author Larry Lawlor	Rev 0	Cross Reference
	8	8I	10			Approval W. Cummins	Date 7-31-72	

RS232C E/A standards define pin 25 of the modem plug as unassigned. The Bell 103E uses pin 25 to provide capabilities to the Data Communications equipment to control the busy status of the modem. In data set cable 7406139, used by the 689 pin 25 is tied to pin 4 (data terminal ready). This connection should be made by a violet wire between pin 25 of the modem plug and pin I on the W023. However, in some cables this connection is made by a jumper between pins 4 and 5 within the modem plug.

If the customer's modem uses pin 25 for some other purpose and it's necessary to break this connection, be on the look out for cables that are jumpered within the modem plug.

NOTE: This same cable is used in the DC10 (with the W023 cut off).

Title 689 AG DATA LINE CONFIGURATION/TESTING						Tech Tip Number 689AG/TT-1		
All	Processor Applicability					Author Bill Cummins	Rev 0	Cross Reference
	8I					Approval Bill Cummins	Date 07/31/72	

Any communication system which has a 689AG option is delivered with its data lines connected to line 0 up through line 32. In that configuration the 689AG diagnostics (maindecs 8I-D8CA and 8I-D8DA) should run satisfactorily. However the customer may, at his own discretion, rearrange options such that the 689AG line 0 is not connected to line 0 of the communication system. When this happens the two diagnostics will not function at all. To make them function the data cables from the 689AG must temporarily be placed in the corresponding slots of the DC08A (0 to 0, 1 to 1, etc.). The diagnostics may then be run; the cables must be reconnected in the customer's configuration after completion of these diagnostic procedures.

Title 708/708A POWER SUPPLIES						Tech Tip Number 708-TT-1		
All X	Processor Applicability					Author Ray Turcotte	Rev A	Cross Reference
						Approval Frank Purcell	Date 7/31/72	

Reference schematic diagrams and parts lists for the 708 and 708A power supplies. No information is listed with respect to resonating capacitor C17. The following information applies to C17 in both supplies.

<u>Power Supply</u>	<u>Component Value</u>	<u>DEC Part No.</u>
708	6 MFD 660 VAC 60 cycle	29-19376
708A	7 MFD 660 VAC 50 cycle	29-15902

Dec Part Numbers for the transformer T1 are:

<u>Power Supply</u>	<u>Vendor #</u>	<u>DEC #</u>
708	T57084	1602755
708A	T57121	1602763

digital	FIELD SERVICE TECHNICAL MANUAL				Option or Designator
	12 Bit <input checked="" type="checkbox"/>	16 Bit <input checked="" type="checkbox"/>	18 Bit <input checked="" type="checkbox"/>	36 Bit <input checked="" type="checkbox"/>	724 to 5409728

Title 50 CYCLE SYSTEM JUMPERS				Tech Tip Number 724-TT-1		
All	Processor Applicability			Author	Rev 0	Cross Reference
	12			Approval H. Long	Date 8/17/72	

All 50 cycle PDP12 systems shipped prior to October, 1971 do not have the proper taps selected on the main power transformer. Although the primary tap selection chart is correct, the secondary taps also have to be changed. If they are not, all of the output voltages will be low and may have up to ½ vac of ripple. This will cause erratic and unreliable operation, especially if the input AC is low.

Reference print D-CS-724-0-1

Wire Color	To Tap	Move to Tape
BRN	7	14
BRN	6	15
ORN	5	16
BLU	4	17
YEL	3	18
YEL	2	19
RED	1	20

Title 860 Power Control Relay Welding Closed				Tech Tip Number 860-TT-1		
All	Processor Applicability			Author Art Zins	Rev 0	Cross Reference
	X			Approval Art Zins	Date 9/20/72	

The 860 power control used in the 11/45 and some option cabinets may have the problem of not being able to shut off AC power by turning off the switch. The reason is because it is possible to draw in rush current in excess of the relay spec. This is generally evident in heavily loaded systems and causes the contacts to weld closed.

A new vendor has been selected to provide a better relay. The ECO was written against the purchase spec only. Hence, the new relay has the same part number as the original (12-10903). These new relays are presently available in F. S. stock. Order these relays on an "as needed" basis - supply is limited.

The new relay is manufactured by Struthers-Dunn Inc. and is physically and electrically compatible with the older version.

Title 54-9728 P.S. REGULATOR BOARD COMPATIBILITY						Tech Tip Number 54-9728-TT-1		
All	Processor Applicability					Author J. Blundell	Rev #	Cross Reference
	8M	8F				Approval F. Purcell	Date 1/14/74	

The new (15") PDP8M/8F chassis requires longer leads on the 54-9728 thermostat than any other equipment using this board.

It is very possible therefore that regulator boards from the F.S. module repair depot will have "normal" length lead (i.e.5") that are too short to make it in the 8M.

There are three things you can do to avoid getting caught.

1. Order a spare thermostat assembly (70-09452) and keep it with the swap kit.
2. Specify to the depot that you need long (approx.10") leads when you request the new regulator board.
3. If you did not make with steps 1 and 2, then the 5" leads can be extended, since the terminating plug is the same on all boards.

Remember, unless requested to do otherwise the depot will always ship short leads.

Boards that have been broken in two, had corners cut off, or had etch damaged by levering components off with a screwdriver without unsoldering are not repairable and have to be scrapped. This reduces the depot float, and has resulted in delays in turnaround.

Please help the depot (and yourselves) by returning defect modules promptly and carefully.

(ALSO SEE POWER SUPPLY SECTION)

digital	FIELD SERVICE TECHNICAL MANUAL				Option or Designator
	12 Bit <input checked="" type="checkbox"/>	16 Bit <input checked="" type="checkbox"/>	18 Bit <input type="checkbox"/>	36 Bit <input type="checkbox"/>	AD01

Title AD01 MULTIPLEXER F.E.T. Leakage				Tech Tip Number AD01-TT-1	
All Processor Applicability			Author R. Adams	Rev 0	Cross Reference
g's	11	s	Approval J. Blundell	Date 12/07/72	

The F.E.T. multiplexers that switch the analogue inputs to the AD01 will float in an undetermined state when power is not supplied to them.

This will result in cross-talk between the inputs and possibly even damage to the F.E.T.'s or the customers equipment in extreme cases.

There is no possibility of a field change to influence the F.E.T. characteristics, (extensive re-design would be necessary), so warn the customers who might be affected directly to keep the AD01 power on when the system is in use.

Title AD01 Source Impedance Problems				Tech Tip Number AD01-TT-2	
All Processor Applicability			Author A. Thompson	Rev 0	Cross Reference
8's	11	s	Approval G. Chaisson	Date 12/08/72	

When using an AD01 A/D converter with more than one channel, the customer will experience bad readings when switching between channels if his source impedance is too high. Only the first readings on the newly selected channel will be in error.

This problem is inherent in A/D converters using the AD01 technique of multiplexing and sampling. It is caused by impedance and capacitance in the cables, wires and components slowing down the system charge time if the source impedance is too high. The error may be as high as 4 or 5 counts on the first conversion and varies with configuration, customer cable length, source impedance, etc.

There are two ways to circumvent this characteristic.

1. Keep source impedance down around 1,000 ohms (1K Ω).
2. If a high source impedance is a customer necessity, have his program select the new channel and/or gain and take two or more conversions, using only the last conversion. The last conversion will be accurate.

-- NOTES --

digital	FIELD SERVICE TECHNICAL MANUAL				Option or Designator AD01A
	12 Bit <input checked="" type="checkbox"/>	16 Bit <input type="checkbox"/>	18 Bit <input type="checkbox"/>	36 Bit <input type="checkbox"/>	

Title AD01A POWER SUPPLY PROBLEMS			Tech Tip Number AD01A-TT-1		
All Processor Applicability		Author G. Chaisson	Rev 0	Cross Reference	
8's		Approval W. Cummins	Date 07/31/72		

Problem: AD01A A/D converters that have AH04 and AH05 (Sample/Hold and Sign bit bipolar) options installed have been exhibiting a power supply problem. The problem is seen when more than three (3) AL24 modules (12 channels) are installed. The symptoms are that the positive 15 volt drops to 8 - 10 volts. This drop in the +15 volt line also causes the +5 to drop and the -15 likewise.

Cause: The cause of this problem is the use of the Deltron P/N 12-03185-3 Power Supply, which during power up, becomes overloaded and due to its inherent characteristics cannot recover from the overload condition.

Correction: An ECO A708-0003 adds a 47 ufd cap. 20V 10% and a 97 Ω 1/2W resistor from collector of Q2 a DEC 2219 transistor to GND, AC.

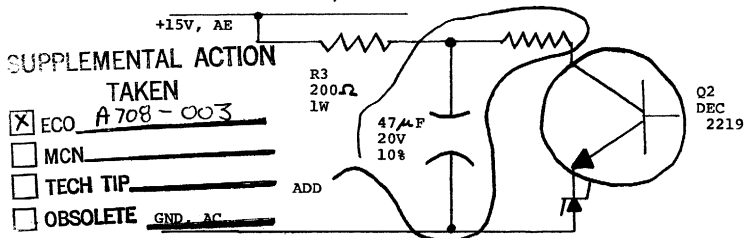

Correction: This problem is also corrected with the installation of a Power Mate power supply P/N 12-03185-3.

NOTE: This is not a problem on AD01-D used with PDP-11's.

Title AD01A INFORMATION - CALIBRATION PROCEDURE CORRECTIONS.						Tech Tip Number AD01A-TT-2	
Processor Applicability				Author Adams/Goelz		Rev 0	
All 8's				Approval W. Cummins		Date 07/31/72	
Cross Reference							

The following are corrections to the AD01-A Calibration Procedures A-SP-AD01-A-06:

Section 4.2.1

Should read: connect the E.D.C. to the A405 input pin A1352 and A13S2 (ground).

Section 4.2.7

Should read; remove A220 module then restart program at 202; adjust the offset coarse pot (Figure 4.2) so that the AC switches from 1776-1777 or as close to this state as possible.

Section 6.2

Add: Remove A220 module.

Section 7

Line 2 should read: (slot A14). Connect the EDC between pins A14P2 and A13F2 (ground).

Line 13 should read: If gross errors are experienced in the last test, remove the A124 from B14.

Line 16 should read: If this test passes but the preceding does not, the problem is probably in the A124 (B14).

Title AD01A - CAUTION NOTES						Tech Tip Number AD01A-TT-3	
Processor Applicability				Author G. Chaisson		Rev 0	
All 8's				Approval W. Cummins		Date 07/31/72	
Cross Reference							

The Maintenance Manual for the AD01-A analog to digital converter **sub-system requires caution** notes be added to the calibration procedure in the appendix. These caution notes are to prevent possible damage to equipment.

AD01-A Calibration Procedure, Section 3, Basic AD01-A, before Section 3.1 add note:

CAUTION: Turn off the AC power to the computer and remove the *A405 and A220 modules. If they are not removed damage may result.

Before Section 3.3 Range Adjustment,

CAUTION: Make certain the *A405 and A220 modules have been removed before setting the EDC voltage to -9.9853 volts.

digital	FIELD SERVICE TECHNICAL MANUAL				Option or Designator
	12 Bit <input checked="" type="checkbox"/>	16 Bit <input type="checkbox"/>	18 Bit <input type="checkbox"/>	36 Bit <input type="checkbox"/>	AD01A to AD08-B

Title AD01A - CAUTION NOTES (Continued)				Tech Tip Number AD01A-TT-3		
All 8's	Processor Applicability			Author G. Chaisson	Rev 0	Cross Reference
				Approval W. Cummins	Date 07/31/72	

Before Section 4 Adjustment of the A405,

NOTE: At this time turn AC power off and replace the A405 in slot AB13. The A220 should remain out at this time.

*A405 is the Sample and Hold module which is optional in this unit.

Title AD01A - INITIAL CONVERSION IN ACCURACY				Tech Tip Number AD01A-TT-4		
All 8's	Processor Applicability			Author G. Chaisson	Rev 0	Cross Reference
	8 8I 8L 8E 11			Approval W. Cummins	Date 07/31/72	

Problem - recently two AD01's have exhibited a peculiar problem when attempting to take conversions and change either gain and/or channel.

The symptoms appear as a non-stable input causing conversion readings to start at an incorrect value. Successive conversions approach a value near what it should be when only one channel is used. Use of more than one channel will disguise these symptoms into hash that may appear meaningless.

Solution - this problem can be observed on a scope at the output of the A220* switch gain amplifier A14 pin V2.

The output waveform should be a very distinctive step (either positive or negative, depending on input) of less than 1 usec rise time as the gain is changed or a different input channel is selected.

Good Wave Form:



Bad Wave Form:



X = values actually converted

Solution - this problem is totally corrected by replacing the A124* used for switching the gain in B14.

* AD01-D A220 Location A16
A124 Location B16

Title TEST ROUTINE FOR AD08-B MULTIPLEXER						Tech Tip Number AD08-B-TT-1				
All	Processor Applicability					Author	G. Chaisson	Rev	0	Cross Reference
	8	8I				Approval	W. Cummins	Date	07/31/72	

The AD08-B maintenance manual, and other sources, suggest short maintenance programs which are incorrect and give indications of problems which do not actually exist.

The following program does work and can be used for most maintenance purposes.

20/7604	Load Channel from SR
** 21/6542	Select Channel and Convert
22/6531	Skip on A/D Done
23/5022	Not done
24/6534	Read A/D Buffer
25/7200	Clear AC
26/6532	A/D Convert
27/6531	Skip on A/D Done
30/5027	Not done
31/6534	Read A/D Buffer
32/2100	Stall Loop
33/5032	JMP .-1
34/5020	JMP and do again

** The IOT 6542 (ADSC) must be followed by an IOT 6531 (ADSF) before attempting to select another channel (6542) or before an A/D convert (6532) can be issued.

George Chaisson June 1970

digital	FIELD SERVICE TECHNICAL MANUAL				Option or Designator
	12 Bit <input checked="" type="checkbox"/>	16 Bit <input type="checkbox"/>	18 Bit <input type="checkbox"/>	36 Bit <input type="checkbox"/>	AD12

Title FAST SAMPLE DISABLE/ENABLE				Tech Tip Number AD12-TT-1		
All	Processor Applicability			Author	Rev 0	Cross Reference
	12			Approval H. Long	Date 08/17/72	

This will not work in a PDP-12 without a KW12 clock. ECO EM12-00009 was generated to rectify this malfunction.

The last section of ECO EM12-00009 is a jumper card (W023) to ground the signal "CLR Mode $\beta\beta$ (1) H.

If this ECO is not installed, for unknown reasons, a jumper between C36T2 and C35C2 will suffice. Therefore, if a KW12 is later installed, the removal of the jumper is necessary.

/mt

* * * * *

Title ALTERNATE AD12 ADJUSTMENT PROCEDURE				Tech Tip Number AD12-TT-2		
All	Processor Applicability			Author Bob Johnson	Rev 0	Cross Reference
	12			Approval G. Sirois	Date 2/12/74	

Problem: AD12 adjustment procedure specified in A-SP-AD12-C-1 and PDP-12 Maintenance Manual Vol. II (Paragraph 3.8.7, pages 3-2) linearly calibrates the AD12 input range for $\pm .987$ volts full scale. Specifications call for ± 1 volt which is 13 mv. greater than the procedure achieves.

Solution: If absolute range of ± 1 volt is required by customer, recalibrate with this procedure. It has the benefit of a more accurate calibration. Calibration occurs at state switching points instead of in the middle of a state.

NOTE: This procedure required only if absolute AD12 accuracy is necessary for customer's application. Both procedures are linear and the difference between the two would be of significance only to those users who require an absolute value of measurement based on the specified ± 1 volt scale. Most laboratory applications use external standards in which range and linearity are a factor, but not absolute value. In research or other applications where absolute value is of interest, the user should be aware of these facts:

- This alternate procedure could make it difficult to correlate old data with new data acquired after adjustment with this procedure, if absolute voltages are being read or if the software is not easily re-calibrated.*
- There will be NO significant effect on applications that use any reference or standard to self calibrate, e.g. Clinilab 12s.*

Title						Tech Tip	
ALTERNATE AD12 ADJUSTMENT PROCEDURE						Number	
						AD12-TT-2	
All		Processor Applicability		Author		Rev	
				R. Johnson		0	
12				Approval		Date	
				G. Sirois		2/12/74	
Cross Reference							

EQUIPMENT NEEDED

Precision DC mv. standard, EDC Model MV-1005 or equivalent and shielded pair input cable with 3 conductor phone plug.

PROCEDURE

1. Load the A/D test as outlined in steps 1 through 9 of the setup procedure paragraph 3.8.5.
2. Allow five minutes warm up time.
3. Connect cable from standard voltage source terminals to channel 10 input.
4. Set voltage source to zero. (Polarity switch to 0).
5. Monitoring channel 10, adjust the right OFFSET potentiometer. module A214, slot E30, for an equal switching between +000 and -000. Turning the trim-pot (Shown in figure 3-21) CCW increases the number.
6. Set voltage source to +0.99805 volts. (Polarity switch to +).
7. Adjust the GAIN potentiometer for an equal switching between +777 and +776.
8. GAIN and OFFSET may interact making it necessary to repeat steps 4 thru 7.
9. Set voltage source to -0.99707. Reading should be -776.
10. Set voltage source to -0.99902. Reading should be -777.
11. Repeat the above procedure for the remaining channels.

<u>LOCATION</u>	<u>LEFT POTENTIOMETERS</u>	<u>RIGHT POTENTIOMETERS</u>
E30	Channel 11	Channel 10
E31	Channel 13	Channel 12
E32	Channel 15	Channel 14
E33	Channel 17	Channel 16

12. For a detailed check of accuracy and linearity, a chart is given. The indicated differences (Δ) need only be taken for one channel since the differential linearity is primarily a function of the ADC and is common to all channels.
13. Keep in mind, that OFFSET will change all voltages equally in a positive or negative direction and that GAIN will change the absolute value proportionately.

digital	FIELD SERVICE TECHNICAL MANUAL				Option or Designator
	12 Bit <input checked="" type="checkbox"/>	16 Bit <input type="checkbox"/>	18 Bit <input type="checkbox"/>	36 Bit <input type="checkbox"/>	AD12 to ADMIN

Title					ALTERNATE AD12 ADJUSTMENT PROCEDURE (CONTINUED)		Tech Tip Number		AD12-TT-2	
All		Processor Applicability			Author		R. Johnson		Rev 0	
12					Approval		G. Sirois		Date 2/14/74	
									Cross Reference	

DISPLAY SWITCHING POINT	ANALOG INPUT LIMITS (VDC)				ACTUAL ANALOG INPUT (VDC)
	MINIMUM		MAXIMUM		
+776 +777	+0.997	070	+0.999	023	
+775 +776	+0.995	117	+0.997	070	
+774 +775	+0.993	164	+0.995	117	
+773 +774	+0.991	211	+0.993	164	
+770 +771	+0.985	352	+0.987	305	
+767 +770	+0.983	398	+0.985	352	
+760 +761	+0.969	727	+0.971	680	
+757 +760	+0.967	773	+0.969	727	
+740 +741	+0.938	477	+0.940	430	
+737 +740	+0.936	523	+0.938	477	
+700 +701	+0.875	977	+0.877	930	
+677 +700	+0.874	023	+0.875	977	
+600 +601	+0.750	977	+0.752	930	
+577 +600	+0.749	023	+0.750	977	
+400 +401	+0.500	977	+0.502	930	
+377 +400	+0.499	023	+0.500	977	
+000 +001	+0.000	977	+0.002	930	
-000 +000	-0.000	977	+0.000	977	
-377 -400	-0.499	023	-0.500	977	
-776 -777	-0.997	070	-0.999	023	

< Indicates that the difference between these points shall be 0.000977V to 0.002930V

Title						Tech Tip		AD12-TT-2		
ALTERNATE AD12 ADJUSTMENT PROCEDURE						Number		to ADMIN		
All	Processor Applicability					Author		Rev		Cross Reference
	12					R. Johnson		0		
						Approval		Date		
						G. Sirofs		2/12/74		

affecting primarily the extreme positive and negative values.

14. One bit represents 1/512 volts or approximately 1.95 mv so the deviation which is the difference between the actual and desired voltages should be within ± 1 mv to meet the specs of $\pm 1/2$ bit resolution.

Title						Tech Tip		Administration		
REPORTING CP/OPTION SERIAL NUMBERS						Number		TT-1		
All	Processor Applicability					Author		Rev		Cross Reference
	8I					Al Kimmel		0		
						Approval		Date		
						B. Cummins		07/31/72		

Field Service Reports are filed, in Maynard, by System Serial Number. Field Service personnel are requested to assist us in maintaining accurate files by accurately reporting identification numbers.

There are two (2) labels associated with the 8/I CP. One indicates the LOGIC SERIAL NUMBER:

Digital Equipment Corporation Maynard, Mass.	LOGIC 1234
---	---------------

or

Digital Equipment Corporation Maynard, Mass.	M26 L1234
---	--------------

The other indicates the SYSTEM SERIAL NUMBER:

Digital Equipment Corporation Maynard, Mass.	M26 5678
---	-------------

This number should be reported on the FIELD SERVICE REPORT

The 26 indicates the PDP-8/I product line charge number.

digital	FIELD SERVICE TECHNICAL MANUAL				Option or Designator AFC
	12 Bit <input checked="" type="checkbox"/>	16 Bit <input type="checkbox"/>	18 Bit <input type="checkbox"/>	36 Bit <input type="checkbox"/>	

Title AFC DIAGNOSTIC					Tech Tip Number AFC-TT-1		
All 8's	Processor Applicability				Author L. Goelz	Rev 0	Cross Reference
					Approval G. Chaisson	Date 07/27/72	

AFC diagnostic does not recognize ASR35/KSR35 or LA30 altmode codes.

When using the AFC-8 diagnostic MAINDEC-08-D6VA on a system that has an ASR35 or KSR35, it is necessary to change a location in the program. This is necessary since the code for the ALTMODE key is different on the 35 (376) than the 33 (375). The change is

Location: 6404 - change from 7403 to 7402

When using an LA30 make the following change (altmode code = 233):

Location: 6404 - change from 7403 to 7545

Title AFC-8 TIMING ADJUSTMENTS					Tech Tip Number AFC-TT-2		
All 8's	Processor Applicability				Author A. Thompson	Rev 0	Cross Reference
					Approval G. Chaisson	Date 12/08/72	

The AFC-8 Diagnostic write-up (Maindec-08-D6VA-DL) contains a Timing Adjustment Procedure (paragraph 5.5.2.1). It presently calls for a 2 ms wide pulse from the M302 at AM04-F02T2 (lower pot).

This pulse being adjusted for only 2 ms will cause the AFC Readings to drift on high gain and will make calibration of the AFC difficult.

Change the procedure to read as follows:

.Adjust lower potentiometer on M302 (located at AM04-F02) for a 3 ms wide pulse.

This is a correction to the AFC-8 Diagnostic Write-up only. The AFC-8 Engineering Specifications calls out a 3 ms wide pulse.

Title		A219 PROGRAMMABLE GAIN AMPLIFIER				Tech Tip Number		AFC -TT-3	
All	Processor Applicability				Author	Larry Goelz	Rev	Ø	Cross Reference
	8				Approval	Bill Freeman	Date	12/05/73	

A219 Programmable Gain Amplifier

The input to this amplifier is fused with a 10 milli-amp fuse. If it becomes necessary to check the fuse for continuity, follow the steps below:

1. Get a high value resistor 10K or greater.
2. Place resistance scale to $R \times 1K$.
3. Put the resistor in series with the fuse then place the meter probes on the fuse and the resistor.
4. If the fuse is good, a movement on the meter should be noticed.

If the fuse needs to be replaced, remove the defective fuse and replace it with a new fuse taking care NOT TO BEND THE FUSE LEADS at any time.

digital	FIELD SERVICE TECHNICAL MANUAL				Option or Designator AG01 To AM08
	12 Bit <input checked="" type="checkbox"/>	16 Bit <input type="checkbox"/>	18 Bit <input type="checkbox"/>	36 Bit <input type="checkbox"/>	

Title AG01 or AG02 PRESTON AMPLIFIERS				Tech Tip Number AG01-TT-1	
All Processor Applicability		Author G. Chaisson		Rev 0	
8	8I	8L	Approval W. Cummins		Date 07/31/72
				Cross Reference	

Suggested PM service of Preston Amplifiers on contract:

The maintenance manual describes three tests for the Preston Amplifiers:

Gain Accuracy
Linearity
Common Mode Rejection

These tests should be made periodically (every 1500 hours of operation) as a part of the PM routine. In addition two other things can be done:

1. A check of the chopper circuit with a scope, checking for noisy signals (noise 50 mv P-P) indicating necessity of replacing the chopper.
2. On a customer requested basis and at a \$60 fix cost replacement of the chopper on a yearly periodic basis. (P/N DEC 29-18313)

These suggestions are an attempt to improve customer satisfaction with service of these units on contract.

Corrective maintenance is normally accomplished by returning the amplifiers to Preston for repair and recalibration.

Title AG01 and AG02 PRESTON AMPLIFIERS				Tech Tip Number AG02-TT-1	
All Processor Applicability		Author G. Chaisson		Rev 0	
8	8I	8L	Approval W. Cummins		Date 07/31/72
				Cross Reference	
				AG01-TT-1	

Title AM08-AM03 TIMING						Tech Tip Number AM03-TT-1		
All	Processor Applicability					Author G. Chaisson	Rev 0	Cross Reference
	8I	9	15	12		Approval W. Cummins	Date	

Low Level Multiplexer

The All1 multiplexer relay modules have been found to bounce and interfere with reliable A/D conversions. This problem appears in two different types of operation. First, if a single channel is selected and reselected the problem can show up. Typically, what a programmer may do is select a channel and allow the channel selection to cause an A/D conversion from the AM08. If another conversion is desired on the already selected channel, a reselection of that channel will cause the A/D conversion but will probably cause that relay to bounce and produce unreliable data. Second case would be if an attempt is made to select channels at a rate greater than 180 channels per second.

The problem stems from the fact that the relays used on the All1 module are specified such that the relay must be opened or closed for a minimum of 2.5 milliseconds. This plus AM08-AM03 timing yields a maximum of 180 selectable channels per second with the stipulation that no channel is reselected. (Reselection of the same channel operates the relay faster than specified.)

An ECO has been written for AM08 timing. If a program cannot be changed, ECO 00006, AM08 could be accomplished to reduce the likelihood of unreliable A/D conversion results.

Title AM08 AM03 - TIMING						Tech Tip Number AM08-TT-1		
All	Processor Applicability					Author G. Chaisson	Rev 0	Cross Reference
	8I	9	15	12		Approval W. Cummins	Date 07/31/72	

digital	FIELD SERVICE TECHNICAL MANUAL				Option or Designator
	12 Bit <input checked="" type="checkbox"/>	16 Bit <input checked="" type="checkbox"/>	18 Bit <input type="checkbox"/>	36 Bit <input type="checkbox"/>	AMPLIFIERS

Title PRESTION AMPLIFIER IDENTIFICATION				Tech Tip Number AMP-TT-1	
All Processor Applicability		Author G. Chaisson		Rev 0	
X		Approval W. Cummins		Date 08/15/72	
				Cross Reference	

DEC has sold a number of various models of Preston Amplifiers. In ordering replacements from logistics it is imperative to be specific with the following information:

MODEL: (Example; H8300, HR8300, HRC8300, WXB8300, etc)

Serial Number on the amplifier (3 letters and 3 digits)

All gain settings X1, X2, X5

All band width settings - 10, 100, 1K,

Programmable gain control or not.

There are a few Preston Amplifiers that are special in that they have only one gain and one bandwidth. These must be identified as such to get the proper replacement.

-- NOTES --

digital	FIELD SERVICE TECHNICAL MANUAL				Option or Designator
	12 Bit <input checked="" type="checkbox"/>	16 Bit <input type="checkbox"/>	18 Bit <input type="checkbox"/>	36 Bit <input type="checkbox"/>	AX08

Title 8I-AX08 INCORRECT PRINTS				Tech Tip Number AX08-TT-1	
All Processor Applicability			Author J. Lacey	Rev 0	Cross Reference
8	8I		Approval W. Cummins	Date 07/31/72	

Problem: Logic Prints do not reflect the following:

1. How RCLK is cleared by the IOT CLRK.
2. How CLYK is cleared by the IOT CLXK.
3. The origin of the signal external.

- Answers:
1. The IOT RCLK is decoded as RCLK (\emptyset), (refer to D-BS-AX08-0-1 sheet 1 at coordinates B 1/2, 6) at pin F of the R113 in slot A14. This signal collector clears the RCLK flip-flop at pin M of the R203 in slot C12 (D-BS-AX08-0-2 at coordinates D, 5).
 2. The IOT CLXK is decoded as XTAL CLK(\emptyset), (D-BS-AX08-0-1 sheet 1 at coordinates B 1/2, 7) at pin K of the R113 in slot A14. This signal collector clears the XTAL CLK flip-flop at pin F of the R203 in slot C12 (D-BS-AX08-0-2 at coordinates D, 2 1/2).
 3. Refer to D-BS-AX08-0-2 coordinates D, 6 and make the following additions.

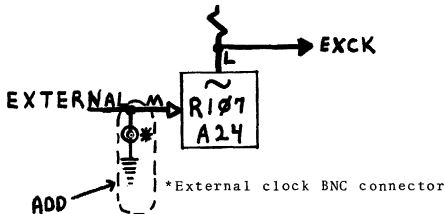

Title AX08 - RANGE CAPACITOR PROBLEM						Tech Tip Number AX08-TT-2		
All	Processor Applicability					Author R. Nunley	Rev 0	Cross Reference
	8	8I	8L			Approval W. Cummins	Date 07/31/72	

Some AX08's have been shipped to the field with some of the range capacitors for the RC clock reversed. If any capacitors are reversed, there will be no output from the RC clock for that position of the range switch. The capacitors are electrolytic and all should have their positive ends connected to the top waffer of the range switch. This waffer may be identified by measuring continuity from the center tap (white wire) to terminal 3 of R4 (fine control below the range switch.

/mt

Title LAB 8/AX08 Wiring Error						Tech Tip Number AX08-TT-3		
All	Processor Applicability					Author Frank Purcell	Rev g	Cross Reference
	8I					Approval D. Dubay	Date 07/31/72	

It has been discovered that all AX08's shipped prior to April 1969 have an error in the wiring of the X display register. The AX08 diagnostic and the Lab-8 software package both run normally. Any customer program which is displaying a base line may have one or two points displayed at random above or below the base line.

The following wiring changes must be made:

Delete B21M to B21V
Delete B17V to B16K
Add B17V to B16J
Add B18M to B16H

Markup the X and Y register print to show that on all X register R205's, the pulse inputs at Pin M are labeled "Load X1"; the pin V inputs should be labeled "Load X2". An ECO is being prepared and will be issued shortly.

SUPPLEMENTAL ACTION TAKEN

- ECO AX08 013
 MCN _____
 TECH TIP _____
 OBSOLETE _____

	FIELD SERVICE TECHNICAL MANUAL				Option or Designator
	12 Bit <input checked="" type="checkbox"/>	16 Bit <input type="checkbox"/>	18 Bit <input type="checkbox"/>	36 Bit <input type="checkbox"/>	BA14

Title					OPTION LIST		Tech Tip Number	BA14-TT-1
All	Processor Applicability				Author	C. Gamage	Rev	0
14					Approval	G. Chaisson	Date	Cross Reference

The following options are used in the BA14 (Basic Accessory Box):

<u>Option</u>	<u>Description</u>
BC14-A	Cable
BK022	Storage Card
BK272	Retentive Memory, Single, Mercury wetted
BK274	Retentive Memory, Dual, Reed
BK302	Timer

Title					Documentation List		Tech Tip Number	BA14-TT-2
All	Processor Applicability				Author	C. Gamage	Rev	0
14					Approval	G. Chaisson	Date	Cross Reference

The following documentation, describing the technical characteristics of the BA14, may be ordered through the Field Service Information Center, Maynard. This service is available to DEC Field Service personnel only.

<u>Designation</u>	<u>Description</u>
BA14- g	Physical Layout print
BA14- g 1	Block Diagram print
K161- g -1	K161 Schematic
K2 g 7- g -1	K2 g 7 Schematic
K135- g -1	K135 Schematic
PDP14 Engineering Note #8	Accessory Box Components and Uses
ECO/FCO Copies	All Field-coded ECOS and FCOs cited in the BA14 DEC-ECO-LOG and the ECO/FCO list of this BA14 manual.

Title ECO/FCO List						Tech Tip Number		BA14-TT-3		
All		Processor Applicability				Author C. Gamaçe		Rev 0		Cross Reference
14						Approval G. Chaisson		Date		

The following ECO/FCO listing is provided to insure that the ECO status of this equipment may be swiftly and accurately determined on site. Note that the "Indication of Accomplishment" column normally lists only a part of the total ECO; the ECO and FCO documents must be consulted if further information is needed.

<u>ECO #</u>	<u>FCO #</u>	<u>Priority</u>	<u>Purpose</u>	<u>Indication of Accomplishment</u>
BA14- 0000 1	None	Optional	Connects GNDs and +5V to form runs	Unit is serial #74 or higher, or a wire is installed from A02V to A03C.
BA14- 0000 2	None	Optional	Allows use of BK274 & BK022	A wire is installed from A04R to B04R.

digital	FIELD SERVICE TECHNICAL MANUAL				Option or Designator
	12 Bit <input checked="" type="checkbox"/>	16 Bit <input type="checkbox"/>	18 Bit <input type="checkbox"/>	36 Bit <input type="checkbox"/>	BB714

Title DOCUMENTATION LIST				Tech Tip Number BB714-TT-1		
All	Processor Applicability			Author C. Gamage	Rev 0	Cross Reference
	14			Approval W. Cummins	Date	

The following documentation, describing the technical characteristics of the BB714, may be ordered through the Field Service Information Center, Maynard. This service is available to DEC Field Service Personnel only.

DESIGNATION	DESCRIPTION
714 Schematics	All 714 power supplies are provided with a schematic printed on the exposed face-plate, with the exception of the Elasco-Eastern unit. The Elasco-Eastern Schematic is provided in this tech manual.
PDP-14 User's Manual	Provides equipment description.

Title ECO/FCO List				Tech Tip Number BB714-TT-2		
All	Processor Applicability			Author C. Gamage	Rev 0	Cross Reference
	14			Approval G. Chaisson	Date	

The following ECO/FCO listing is provided to insure that the ECO status of this equipment may be swiftly and accurately determined on site. Note that the "Indication of Accomplishment" column normally lists only a part of the total ECO; the ECO and FCO documents must be consulted if further information is needed.

<u>Equipment</u>	<u>ECO</u>	<u>Priority</u>
714 (Digital) (PDP-14 Power Supply)	None	Any revision DEC 714 power supply is suitable for field use and may be recognized by the "Digital" name printed on the side of the H frame in which the components are mounted.
714 (Armor) (PDP-14 Power Supply)	None	Any Armor 714 power supply is suitable for field use and may be recognized by the name "Armor" printed on the side of the H frame in which the components are mounted.
714 (North Electric) (PDP-14P.S.)	<u>Mandatory</u>	NO North Electric 714 power supplies are considered suitable for field use in PDP-14s. They may be recognized by the "North Electric, Co." name printed on the side of the H frame in which the components are mounted (directly below the schematic).

Title ECO/FCO List (Continued)					Tech Tip Number BB714-TT-2				
All	Processor Applicability				Author	C. Gamage	Rev	0	Cross Reference
	14				Approval	G. Chaisson	Date		

Equipment ECO Priority

714 (Elasco-Eastern) (PDP-14 P.S.) NOTE: The Elasco-Eastern 714 power supply required the following changes under the conditions described:

<u>ECO Change</u>	<u>Priority</u>	<u>Units Affected</u>	<u>Purpose</u>	<u>Indications of Accomplishment</u>
<u>Change 1</u>	<u>Mandatory</u> Except in cases where Change 2, below, was field installed,	Elasco-Eastern 714 Power Supplies shipped after 12/1/69. This is a <u>manufacturer installed</u> change only.	Filters line noise	1.0K OHM resistor installed to right of Q1 as shown in Figure 1-714-A.

<u>Change 2</u>	<u>Mandatory</u> in cases where the above change 1 was not installed by vendor.	Elasco-Eastern 714 power supplies shipped before 12/1/69. This is a field-installed change.	Filters line noise	1.0K OHM resistor installed in series with C3 as shown in Figure 1-714-B.
-----------------	--	---	--------------------	---

<u>ECO</u>	<u>FCO</u>	<u>Priority</u>	<u>Purpose</u>	<u>Indication of Accomplishment</u>
14- 00050	14-C 0050	Phase-in (to be implemented on an "as-fails" basis after June 30, 1972)	Product Improvement	Power Supply is part number 121 9980 .

digital	FIELD SERVICE TECHNICAL MANUAL				Option or Designator BB714
	12 Bit <input checked="" type="checkbox"/>	16 Bit <input type="checkbox"/>	18 Bit <input type="checkbox"/>	36 Bit <input type="checkbox"/>	

Title PARALLEL OPERATION OF 714 POWER SUPPLIES				Tech Tip Number BB714-TT-3	
All	Processor Applicability			Author C. Gamage	Rev 0
	14			Approval G. Chaisson	Date
					Cross Reference

The need for dual 714 power supply operation may be determined by adding the current drains of each load fed by the +5V source, and installing another 714 when the total reaches more than 7.0 amps (this an absolute high limit). See Table BB714-A.

TABLE BB714-A

UNIT	DC AMPS @ 5 VDC
14 Control Unit	2.50
Memory, 1 K	0.50
I Box	0.05
O Box	0.60
A Box	0.60
S Module	0.10
Computer Interface	0.40

Installation of a second 714 power supply requires the installation of the wires shown in Figure BB714-B.

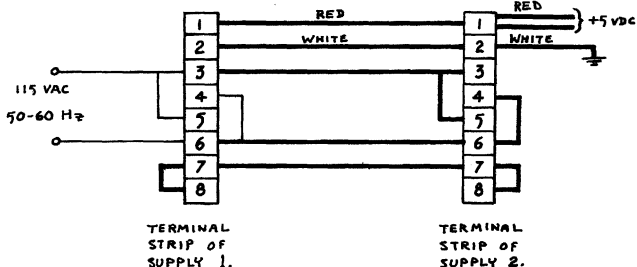
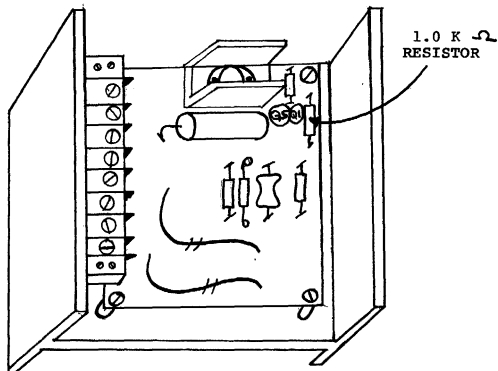

FIGURE BB714-B

Title PARALLEL OPERATION OF 714 POWER SUPPLIES (CON'T)				Tech Tip Number BB714-TT-3		
All	Processor Applicability			Author C. Gamage	Rev 0	Cross Reference
	14			Approval G. Chaisson	Date	



ELASCO-EASTERN POWER SUPPLY
WITH FACTORY-INSTALLED CHANGE

- FIGURE 1-714-A -

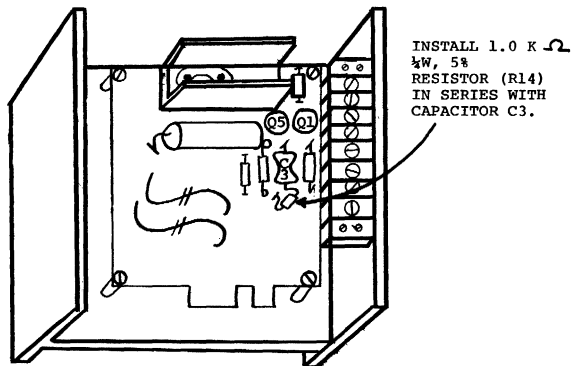

ELASCO-EASTERN POWER SUPPLY
WITH FIELD-INSTALLED CHANGE

- Figure 1-714-B -

DIGITAL EQUIPMENT CORPORATION

Title BC01V WIRING ERROR						Tech Tip Number BC01-TT-1	
All Processor Applicability		Author Bill Freeman		Rev 0		Cross Reference	
8E		Approval W.E. Cummins		Date 06/06/72			

Some BC01V cables have made their way to the field which have the black wire that should be attached to pin VV on the Berg cable terminator connected to the unlabeled slot below pin VV. To correct this problem move the wire from the incorrect position to the proper one.

The BC01V cables can be used on KL8E/A-G, KL8FA-K, DP8EA.

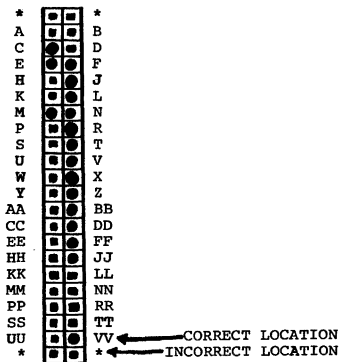

Title NO POWER LOW FROM 8E ENABLE BOX BA8-A or BA8-B						Tech Tip Number BC08H-TT-1	
All Processor Applicability		Author J. Blundell		Rev 0		Cross Reference	
X		Approval F. Purcell		Date 09/20/72			

BC08H omnibus expander cables using a Rev. C M936 may fail to bring power low up to the processor from the expander box because the jumper from the cable to pin BV2 of the M936 is missing.

Check for this jumper on any systems using the BC08H cable, especially if you have power low problems.

/mt

CPL

digital	FIELD SERVICE TECHNICAL MANUAL				Option or Designator BC08J
	12 Bit <input checked="" type="checkbox"/>	16 Bit <input checked="" type="checkbox"/>	18 Bit <input checked="" type="checkbox"/>	36 Bit <input checked="" type="checkbox"/>	

Title STRAIN RELEASE FOR BERG CONNECTOR				Tech Tip Number BC08J-TT-1	
All	Processor Applicability	Author J. Blundell	Rev 0	Cross Reference	
X		Approval G. Chaisson	Date 9-1-72		

PROBLEM: 40 conductor cable coming out of Berg connector in cable assemblies such as BC08J, K, and L. Tends to get damaged with excessive handling.

SOLUTION: Berg make a cable clamp with four plastic fingers that lock into the unused pin holes at each end of the plug, and two adhesive bars that grip the cable (See drawing below)

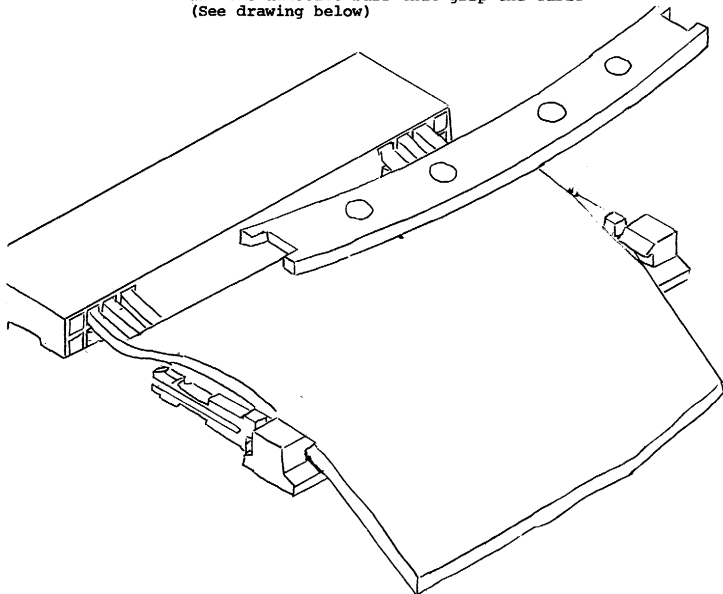

DEC part number is 12-11166 for the complete assembly.
Berg part numbers are 65-33100 and 65-332001.
They may be ordered from the F.S stockroom under the DEC part number

COMPANY CONFIDENTIAL

-- NOTES --

digital	FIELD SERVICE TECHNICAL MANUAL				Option or Designator
	12 Bit <input checked="" type="checkbox"/>	16 Bit <input type="checkbox"/>	18 Bit <input type="checkbox"/>	36 Bit <input type="checkbox"/>	BC08M to BC14A

Title BC08M-OM CONNECTOR				Tech Tip BC08M TT-1 Number		
All	Processor Applicability			Author Ralph Boehm	Rev 0	Cross Reference
	8E			Approval W.E. Cummins	Date 07/31/72	

Some BC08M-OM over the top connectors have been manufactured with 10 OHM resistors on pins A2, B2, U1 and V2. The use of the connectors with the resistors can cause signal problems.

These resistors should be removed and jumpers installed.

/mt

Title Documentation List						Tech Tip Number BC14A-TT-1		
All	Processor Applicability					Author C. Gamage	Rev 0	Cross Reference
	14					Approval G. Chaisson	Date	

The following documentation, describing the technical characteristics of the BC14-A, may be ordered through the Field Service Information Center, Maynard. This service is available to DEC Field Service personnel only.

<u>Designation</u>	<u>Description</u>
BC14A- ϕ - ϕ	Cable Assembly Print
B-CS-G782- ϕ -1	G782 Connector Print
ECO Copies	All Field-coded ECOs and FCOs cited in the BC14A DEC-ECO-LOG and the ECO/FCO list of this BC14A Manual.

Title ECO/FCO LIST						Tech Tip Number BC14A-TT-2		
All	Processor Applicability					Author C. Gamage	Rev ϕ	Cross Reference
	14					Approval G. Chaisson	Date	

The following ECO/FCO listing is provided to insure that the ECO status of this equipment may be swiftly and accurately determined on site. Note that the "Indication of Accomplishment" column normally lists only a part of the total ECO; the ECO and FCO documents must be consulted if further information is needed.

<u>ECO</u>	<u>FCO</u>	<u>Priority</u>	<u>Purpose</u>	<u>Indication of Accomplishment</u>
BC14A- $\phi\phi\phi\phi$ Y	None	Low	Eliminates +5V line loss.	Cable is 2 ϕ conductor ribbon (multi-colored).
G782-00001	None	<u>MANDATORY</u>	Eliminates effect of weak diodes	All diodes are D672.
		Note: Few G782 Cards needing this ECO still remain in Field use.		

COMPANY CONFIDENTIAL

PAGE 48	PAGE REVISION 0	PUBLICATION DATE July 1972
---------	-----------------	----------------------------

digital	FIELD SERVICE TECHNICAL MANUAL				Option or Designator BC14C
	12 Bit <input checked="" type="checkbox"/>	16 Bit <input type="checkbox"/>	18 Bit <input type="checkbox"/>	36 Bit <input type="checkbox"/>	

Title BC14C-10 USES AND RESTRICTIONS				Tech Tip Number BC14C-TT-1	
All	Processor Applicability			Author C. GAMAGE	Rev 0
14				Approval W.E. Cummins	Date 8-15-72
					Cross Reference

There have been no ECO's issued against the BC14C option. There have been no publications released describing the BC14C and/or its use.

The BC14C-10 test unit and its substitute, the handwired harness shown in Figure 3-1, are special purpose items. Their use is restricted to testing BX14DA and BY14DA options upon installation in conjunction with Maindec Test 14 and Test 14L; they must not be used after the I/O boxes are connected to their respected machineries or on any I/O boxes using DC I/O modules.

Input/Output tests are performed with Maindec Test 14 (Test 14L), and test unit BC14C-10 or its handwired substitute:

Designating a BY14DA box as half-S box during the interrogation portion of Maindec Test 14 (or Test 14L), will test the performance of an output box with the exception of the K614 modules. To satisfactorily test all of the hardware in (1) I-Box and (1) O-Box the connections shown in Figure 3-1 must be made to an output box assigned to PDP-14 mainframe slot C32 (PDP-14L slot E03) and to an input box assigned to PDP-14 mainframe slot A32 (PDP-14L slot C04).

The BC14C-10 test unit provides the connections shown in Figure 3-1 by the use of a 17 (10) conductor ribbon and (2) connector assemblies. The BC14C-10 is mounted on the I/O boxes as shown in Figure 3-2.

Installation I/O testing is performed by connecting each I/O box (in turn) to its slot in the 14 or 14L, providing the test connections shown in Figure 3-1 or 3-2, and running Maindec Test 14 (or Test 14L) while declaring with a type-in that the system has (1) I-box and (1) O-box.

Title BCL4C-10 USES AND RESTRICTIONS (Continued)		Tech Tip Number BCL4C-TT-1	
All	Processor Applicability	Author C. Gamage	Rev 0
		Approval G. Ghaissou	Date August 18
14			Cross Reference

INPUT BOX
CONNECTIONS
(FRONT VIEW)

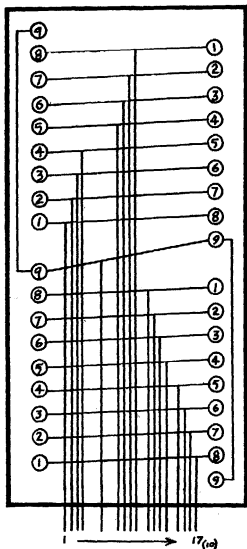

OUTPUT BOX
CONNECTIONS
(FRONT VIEW)

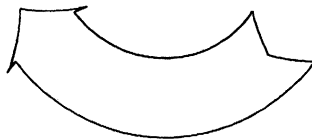
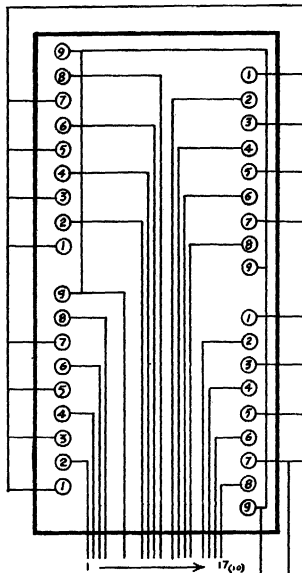

I/O BOX TEST CONNECTIONS
FIGURE 3-1

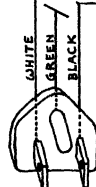

50/60 Hz 115vac

digital	FIELD SERVICE TECHNICAL MANUAL				Option or Designator
	12 Bit <input checked="" type="checkbox"/>	16 Bit <input type="checkbox"/>	18 Bit <input type="checkbox"/>	36 Bit <input type="checkbox"/>	BC14C to BK272

Title BC14C-10 USES AND RESTRICTIONS (Continued)				Tech Tip Number BC14C-TT-1	
All	Processor Applicability		Author C. Gamage	Rev 0	Cross Reference
	1d		Approval G. Chaisson	Date 08.18.72	

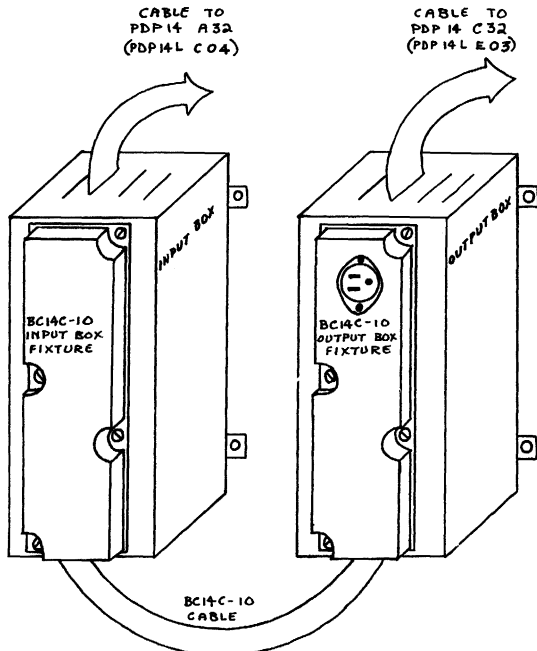

I/O BOX TESTER - MOUNTED

Figure 3-2

Title DOCUMENTATION LIST						Tech Tip Number BK022-TT-1		
All	Processor Applicability					Author W. Cummins	Rev 0	Cross Reference
	14					Approval G. Chaisson	Date	

The following documentation, describing the technical characteristics of the BK022, may be ordered through the Field Service Information Center, Maynard. This service is available to DEC Field Service Personnel only.

<u>Designation</u>	<u>Description</u>
CS-K022-0-1	K022 Schematic
PDP-14 Engineering Note #8	<u>Accessory Box Components and Uses</u>

NOTE: This option consists of the K022 module only, and is normally used in the BA14 assembly.

Title Documentation List						Tech Tip Number BK272-TT-1		
All	Processor Applicability					Author C. Gamage	Rev 0	Cross Reference
	14					Approval G. Chaisson	Date	

The following documentation, describing the technical characteristics of the BK272, may be ordered through the Field Service Information Center, Maynard. This service is available to DEC Field Service personnel only.

<u>Designation</u>	<u>Description</u>
B-CS-K272-0-1	K272 Schematic
PDP-14 Engineering Note #8	<u>Accessory Box Components and Uses</u>
PDP-14 User's Manual	Provides equipment description

NOTE: This option consists of the K272 module only, and is normally used in the BA14 assembly.

digital	FIELD SERVICE TECHNICAL MANUAL				Option or Designator
	12 Bit <input checked="" type="checkbox"/>	16 Bit <input type="checkbox"/>	18 Bit <input type="checkbox"/>	36 Bit <input type="checkbox"/>	BK274 to BK302

Title Documentation List					Tech Tip Number BK274-TT-1		
All	Processor Applicability				Author C. Gamage	Rev 0	Cross Reference
	14				Approval G. Chaisson	Date	

The following documentation, describing the technical characteristics of the BK274, may be ordered through the Field Service Information Center, Maynard. This service is available to DEC Field Service personnel only.

Designation	Description
CS-K274-0-1	K274 Schematic

NOTE: This option consists of the K274 module only, and is normally used in the BA14 assembly.

Title DOCUMENTATION LIST					Tech Tip Number BK302-TT-1		
All	Processor Applicability				Author C. Gamage	Rev 0	Cross Reference
	14				Approval G. Chaisson	Date	

The following documentation, describing the Technical Characteristics of the BK302, may be ordered through the Field Service Information Center, Maynard. This service is available to DEC Field Service Personnel only.

<u>Designation</u>	<u>Description</u>
B-CS-K302-0-1	K302 Schematic
PDP-14 Engineering Note #8	<u>Accessory Box Components and Uses</u>
PDP-14 User's Manual	Provides equipment description

NOTE: This option consists of the K302 module only, and is normally used in the BA14 assembly.

-- NOTES --

digital	FIELD SERVICE TECHNICAL MANUAL				Option or Designator
	12 Bit <input checked="" type="checkbox"/>	16 Bit <input checked="" type="checkbox"/>	18 Bit <input checked="" type="checkbox"/>	36 Bit <input type="checkbox"/>	BW406

Title					Tech Tip Number	
USING BW406 MODULE					BW406-TT-1	
Processor Applicability					Author	Rev
All	8	11	15		t. Goelz	0
					Approval	Date
					G. Chaisson	2/1/74
					Cross Reference	
					W406-TT-1	

This module is the latest signal conditioning module for the UDC 8, 11, 15. It has been released to ultimately replace the W400, W402, W403. In order to test the W406, the UDC tester is used just as the procedures state without any modifications.

The module appears to be identical to the W400. In order for the customer to have the capability that the W402, W403 provided, he must wire his screw terminals in a certain way. This information will be contained in the UDC manuals.

-- NOTES --

digital	FIELD SERVICE TECHNICAL MANUAL				Option or Designator
	12 Bit <input checked="" type="checkbox"/>	16 Bit <input type="checkbox"/>	18 Bit <input type="checkbox"/>	36 Bit <input type="checkbox"/>	BX14-DA

Title DOCUMENTATION LIST				Tech Tip Number BX14-DA-TT-1	
All	Processor Applicability			Author L. Goelz	Rev 0
	14			Approval G. Chaisson	Date 09/20/72
					Cross Reference

The following is a list of documentation available for the BX14-DA.

<u>Designation</u>	<u>Description</u>
UA-BX14-DA-0	Unit Assembly Drawing
BS-BX14-DA-1	Block Schematic
PL-BX14-DA-0	Parts List
CS-K136-0-1	Circuit Schematic K136
CS-K161-0-1	Circuit Schematic K161
CS-K578-0-1	Circuit Schematic K578

/mt

Title ECO/FCO LIST				Tech Tip Number BX14-DA-TT-2	
All	Processor Applicability			Author L. Goelz	Rev 0
	14			Approval G. Chaisson	Date 09/20/72
					Cross Reference

<u>EQUIPMENT</u>	<u>ECO CHANGE</u>	<u>PRIORITY</u>	<u>UNITS AFFECTED</u>	<u>PURPOSE</u>	<u>INDICATIONS OF ACCOMPLISHMENT</u>
BX14-DA (Input Box)	BX14 DA-000 06	MANDA- TORY	BX14DA S/N 377 & prior	Connects GNDS & +5V pins to form runs	Presence of wire from A04C to B01C in BX14.
	BX14DA -00007	Optional	See "k136"	Slows ckt response	Input box contains K136 in slot B02
K578 (AC Input Module)	K578- 00002	Optional unless input AC signals	Etch Rev. A boards receiving signals less than 500 ms in repair time. duration (cam switches, etc.)	Decreases response time production costs & 500 ms in repair time.	Board is etch Rev. B or higher.

Title ECO/FCO LIST (Continued)						Tech Tip Number BX14-DA-TT-2		
All	Processor Applicability					Author	Rev	Cross Reference
	14					L. Goelz	0	
					Approval	Date		
					G. Chaisson	Sept. 20		

<u>EQUIPMENT</u>	<u>ECO CHANGE</u>	<u>PRIORITY</u>	<u>UNITS AFFECTED</u>	<u>PURPOSE</u>	<u>INDICATIONS OF ACCOMPLISHMENT</u>
K136 (Inverter)	None	Installation Optional	Controllers	Replace K136 to experienc- ing "False Inputs" passage due to of high high mag- speed nitude high short magnitude duration pulses	Input box contains K136 in slot B02. ECO BX14-DA 00007 completed.

NOTE:

These pulses are developed between the hot or common inputs and the input box chassis. Prior to installation of a K136, an attempt should be made to operate the system with a ground connection installed between the input box chassis and the machine chassis (lathe, etc.). This should be #6 wire or heavier. Care should be taken on all installed grounds to insure metal-to-metal contact; use good solid lugs and star washers; avoid the use of split lock-washers as substitutes since they do not break through the paint layer until the securing machine screw is backed out. Do not replace a K136 with a K135 except in an emergency.

K161

(Decoder)	K161- 00001	MANDATORY	All etch Rev. A K161 boards	Provides reference for Q7 & Q8	Board is etch Rev. "B" or higher, or R8 and R9 have been removed from Rev. A board.
	K161- 00001	Optional	Etch Rev. C K161 Modules	Defeats noise on address lines.	Module is etch Rev. D or higher.

digital	FIELD SERVICE TECHNICAL MANUAL				Option or Designator
	12 Bit <input checked="" type="checkbox"/>	16 Bit <input type="checkbox"/>	18 Bit <input type="checkbox"/>	36 Bit <input type="checkbox"/>	BX14-DD

Title DOCUMENTATION LIST					Tech Tip Number BX14-DD-TT-1		
All	Processor Applicability				Author L. Goelz	Rev 0	Cross Reference
	14				Approval G. Chaisson	Date 9-21-72	

The following is a list of documentation available for the BX14-DD

<u>DESIGNATION</u>	<u>DESCRIPTION</u>
UA-BX14-DD-0	Unit Assembly Drawing
BS-BX14-DD-0	Block Schematic
PL-BX14-DD-0	Parts List
CS-K136-0-1	Circuit Schematic K136
CS-K161-0-1	Circuit Schematic K161
CS-K564-0-1	Circuit Schematic K564

Title ECO/FCO LIST					Tech Tip Number BX14-DD-TT-2		
All	Processor Applicability				Author L. Goelz	Rev 0	Cross Reference
					Approval G. Chaisson	Date 9-21-72	

<u>Equipment</u>	<u>ECO Change</u>	<u>Priority</u>	<u>Units Affected</u>	<u>Purpose</u>	<u>Indications of Accomplishment</u>
K136 (Inverter)	None	Installation optional	Controllers experienced "False Inputs" due to high magnitude short duration pulses which pass onto the sample return line while other inputs are being tested	Replace K136 to prohibit passage speed	Input box contains K136 in slot B02. ECO BX14-DA-00007 completed.

Note: The pulses are developed between the hot or common inputs and the input box chassis. Prior to installation of a K136, an attempt should be made to operate the system with a ground connection installed between the input box chassis and the machine chassis (lathe etc). This should be #6 wire or heavier. Care should be taken on all installed grounds to insure metal-to-metal contact, use good solid lugs and star washers, avoid the use of split lock-washers as substitutes since they do not break through the paint layer until the securing machine screw is backed out. Do not replace a K136 with a K135 except in an emergency.

Title						Tech Tip	
ECO/FCO LIST						Number BX14-DD	
All		Processor Applicability		Author L. Goelz		Rev 0	
14				Approval G. CHaisson		Date 9-21-72	
						Cross Reference	

K161 Optional Etch Rev Defeats Module is etch revision D
00002 K161 MdIs noise on or higher
address
lines

Title						Tech Tip	
INSTALLATION TESTS OF DC I/O BOXES						Number BX14-DD-TT-3	
All		Processor Applicability		Author L. Goelz		Rev 0	
				Approval		Date 8/1/73	
						Cross Reference	

INSTALLATION TESTS OF DC I/O BOXES

DC I/O tests are performed with SIM-14 after confirming proper operation of the PDP-14 (or 14L) mainframe with MAINDEC TEST (or Test 14L). A voltage source providing +10 to +55 VDC (for I-Box Tests), or +10 to 250 VDC (for O-Box tests), is required, and is normally customer supplied.

NOTE: These tests must NOT be performed on AC I/O boxes, or on any DC I/O boxes already connected to their respective machineries. The BC14C test unit must NOT be used in testing any DC I/O box.

DC I-Box Tests:

- 1) Load SIM-14 using Binary Loader.
- 2) Turn off power. Connect the I-Box cable, BC14A, to PDP-14 slot A32 (PDP-14L slot C04).
- 3) Connect the neutral (earth grounded) side of the +10 to +55 VDC power supply (provided by customer) to terminal 9 (GND) of each K564 input module (4 modules per box). See Figure 3-4. If the DC power source provides +10 to +24 VDC, all K564 modules must have ground connected to terminal 9 only; if the DC power source provides +24 to +55 VDC, all K564 modules must have an additional jumper between terminals 9 and 10. If the DC power source exceeds +55 VDC, an external resistor must be installed in series with each input.
- 4) Turn power on. Load and start 2200.
- 5) Type "OM" and "RETURN" on the TTY.
- 6) Place the plus side of the power supply on the first input, X0. See Figure 3-4.
- 7) Type "IX0-377" and "RETURN" on the TTY. The program will then tell you every input that indicates "on" by typing:

digital	FIELD SERVICE TECHNICAL MANUAL				Option or Designator
	12 Bit <input checked="" type="checkbox"/>	16 Bit <input type="checkbox"/>	18 Bit <input type="checkbox"/>	36 Bit <input type="checkbox"/>	BX14-DD-TT-3

Title				Tech Tip	
INSTALLATION TESTS OF DC I/O BOXES				Number	
Processor Applicability				BX14-DD-TT-3	
All	Author		Rev		Cross Reference
	I. Goetz		0		
	Approval		Date		
	G. Chaisson		8/1/73		

000 1 (indicating input X000 is in the "1" state)

Only the input with the positive lead connected to it should indicate "on".

- 8) Remove the positive lead from the K564 terminal and repeat steps 6, 7, and 8, testing each of the 8 terminals on each K564 (0 through 37 octal for this box). See Figure 3-4.

DC O-Box Tests:

- 1) Load SIM-14 using Binary Loader.
- 2) Turn off power. Connect the O-Box cable, BC14A, to PDP-14 slot C32 (PDP-14L slot E03).
- 3) Connect the positive side of the +10 to +250 VDC power supply to terminal 9 of each K657 module; see Figure 3-5 (note that the output voltage rating of the K657 module is greater than that of the K564 input module, therefore terminal 10 is not used). The maximum current output of each K657 terminal is 1 ampere; the K657 outputs are not fused in the module.
- 4) Connect the neutral side (earth ground) of the +10 to +250 VDC power supply to terminals 2, 4, 6 and 8, of each K657 module; see Figure 3-5.
- 5) Turn on power.
- 6) Load and start 2200.
- 7) Type "OM" and "RETURN" on the teletype.
- 8) Type "IY0-377" and "RETURN". All outputs should be off, and the TTY should type a single "0".
- 9) Type "YN0-17" and "RETURN". The PDP-8 Family computer will halt; hit the continue switch on the computer 16 (decimal) times. The lights in the output box should come on in sequence. See Figure 3-5.
- 10) Type "IY0-377" and "RETURN" on the TTY. The program should type out, indicating that only outputs 0-17 are "on".
- 11) Type "YF0-17" and "RETURN" on the TTY. The computer will halt; hit the PDP-8 Family computer continue switch 16 (decimal) times. The lights should go out in sequence.

Title						Tech Tip	
INSTALLATION TESTS OF DC I/O BOXES						Number BX14-DD-TT-3	
All			Processor Applicability		Author		Cross Reference
					I. Goelz		
					Rev		
					Ø		
					Approval		
					G. Chaisson		
					Date		
					8/1/73		

- 12) Type "IYØ-377" and "RETURN" on the TTY. All outputs should be off, and SIM-14 should type out a single "Ø".
- 13) Repeat steps 2 through 12 for each DC O-Box to be tested.

NOTE: A DC output, when "on" provides a path for electron flow from earth ground, through the K657, through the load (relay coil, etc.), to the + VDC source. See Figure 3-6. Therefore, when the output in question is connected to a load, and is turned "on", that output terminal will read nearly ground potential. This information is provided to expedite troubleshooting; no customer loads may be connected to the O-Box while performing installation tests.

digital	FIELD SERVICE TECHNICAL MANUAL				Option or Designator
	12 Bit <input checked="" type="checkbox"/>	16 Bit <input type="checkbox"/>	18 Bit <input type="checkbox"/>	36 Bit <input type="checkbox"/>	BX14-DD

Title					Tech Tip	
INSTALLATION TESTS OF DC I/O BOXES					Number BX14-DD-TT-3	
All	Processor Applicability			Author	Rev	Cross Reference
				L. Goetz	0	
				Approval	Date	
				G. Chaisson	8/1/73	

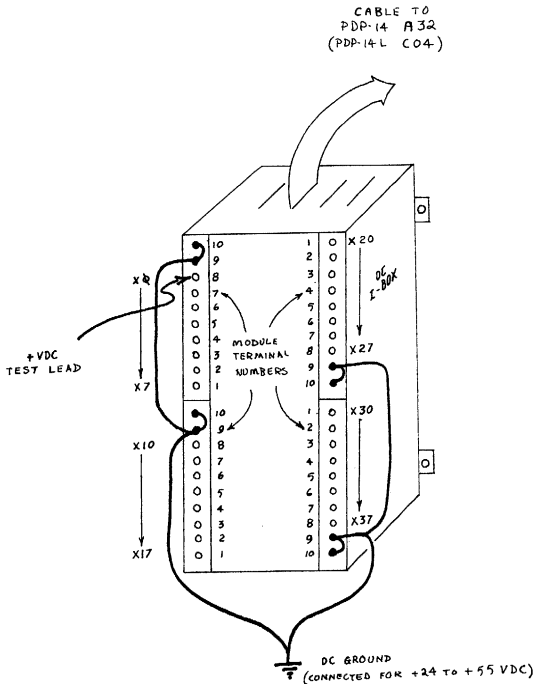

DC I-BOX INSTALLATION TEST CONNECTIONS
— FIGURE 3-4 —

Title					Tech Tip	
INSTALLATION TESTS OF DC I/O BOXES					Number BX14-DD-TT-3	
All		Processor Applicability		Author I. Goelz	Rev β	Cross Reference
				Approval G. Chaisson	Date 8/1/73	

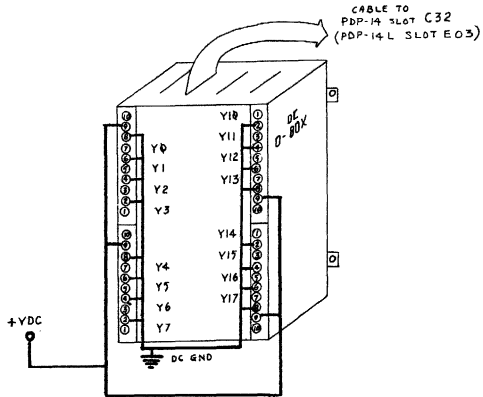

DC I/O-BOX TEST CONNECTIONS
— FIGURE 3-5 —

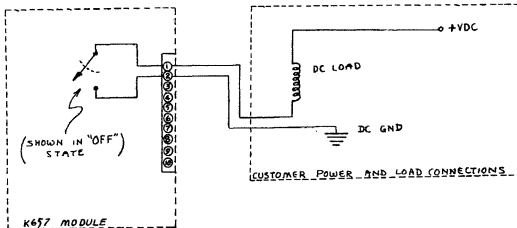

DC I/O-BOX SWITCHING PRINCIPLE
— FIGURE 3-6 —

digital	FIELD SERVICE TECHNICAL MANUAL				Option or Designator
	12 Bit <input checked="" type="checkbox"/>	16 Bit <input type="checkbox"/>	18 Bit <input type="checkbox"/>	36 Bit <input type="checkbox"/>	BX14-SA

Title	DOCUMENTATION LIST	Tech Tip Number	BX14-SA-TT-1
All	Processor Applicability	Author	Larry Goelz
		Rev	0
14		Approval	G. Chaisson
		Date	9-20-72
			Cross Reference

The following is a list of documentation available for the BX14-SA.

<u>DESIGNATION</u>	<u>DESCRIPTION</u>
UA-BX14-SA-0	Unit Assembly Drawing
BS-BX14-SA-0	Block Schematics
PL-BX14-SA-0	Parts List
CS-K579-0-1	Circuit Schematic K579
CS-K161-0-1	Circuit Schematic K161
CS-K136-0-1	Circuit Schematic K136

Title	ECO/FCO LIST	Tech Tip Number	BX14-SA-TT-2
All	Processor Applicability	Author	Larry Goelz
		Rev	0
14		Approval	G. Chaisson
		Date	09/20/72
			Cross Reference

<u>EQUIPMENT</u>	<u>ECO CHANGE</u>	<u>PRIORITY</u>	<u>UNITS AFFECTED</u>	<u>PURPOSE</u>	<u>INDICATIONS OF ACCOMPLISHMENT</u>
------------------	-------------------	-----------------	-----------------------	----------------	--------------------------------------

K136 (Invtr)	None	Install tion optional	Controller experiencing "False Inputs due to high magnitude of short duration pulses which pass onto the sample return line while other inputs are being tested	Replace K136 to prohibit high speed high magnitude pulses	Input box contains K136 in slot B02. ECO B14DA- 00007 completed
		NOTE:	These pulses are developed between the hot or common inputs and the input box chassis. Prior to installation of a K136, an attempt should be made to operate the system with a ground connection installed between the input box chassis and the machine chassis (lathe, etc.) This should be #5 wire or heavier. Care should be taken on all installed grounds to insure metal-to metal contact, use good solid lugs and star washers, avoid the use of split lock washers as substitutes since they do not break through the paint layer until the securing machine screw is back out. Do not replace a K136 with a K135 except in an emergency.		

Title ECO/FCO LIST						Tech Tip Number BX14-SA-TT-2		
All	Processor Applicability					Author Larry Goelz	Rev 0	Cross Reference
	14					Approval G. Chaisson	Date 9-20-72	

K161 (decoder)	K161 00001	<u>MANDATORY</u>	All etch Rev. A K161 boards	Provides reference for Q7 and Q8	Board is etch Rev. "B" or higher, or R8 and R9 have been removed from Rev. A board.
	K161 00002	Optional	Etch C K161 modules	Defeats noise on address lines	Module is etch revision D or higher
K579 Trigger Input Module	K579 00002	<u>MANDATORY</u>	Modules shipped before 3-14-72	Defeats noise.	C4 is missing, see FCO K579-C0002

Title K135 CAN NOT BE USED IN BX14-SA						Tech Tip Number BX14-SA-TT-3		
All	Processor Applicability					Author John L. Breyer	Rev 0	Cross Reference
	14					Approval Fred Silva	Date 7/31/74	

The PDP14 literature does not state specifically that a K135 can not be used in a BX14-SA, although it does say that a K136 should not be replaced by a K135. A K135 will not work because the BX14-SA backplane does not have ground wired to B#2T and B#2V. The failure symptom of a K135 in a BX14-SA is that any time that "I" box is addressed, all of its inputs will be read as "on."

digital	FIELD SERVICE TECHNICAL MANUAL				Option or Designator BY14-DA
	12 Bit <input checked="" type="checkbox"/>	16 Bit <input type="checkbox"/>	18 Bit <input type="checkbox"/>	36 Bit <input type="checkbox"/>	

Title DOCUMENTATION LIST				Tech Tip Number BY14-DA-TT-1	
All	Processor Applicability			Author Larry Goelz	Rev 0
	14			Approval George Chaisson	Date 9-21-72
					Cross Reference

The following is a list of documentation available for the BY14-DA

<u>DESIGNATOR</u>	<u>DESCRIPTION</u>
UA-BY14-DA-0	Unit Assembly Drawing
PL-BY14-DA-0	Parts List
BS-BY14-DA-1	Block Schematic
CS-K614-0-1	Circuit Schematic K614
CS-K135-0-1	Circuit Schematic K135
CS-K161-0-1	Circuit Schematic K161
CS-K207-0-1	Circuit Schematic K207

Title ECO/FCO LIST				Tech Tip Number BY14-DA-TT-2	
All	Processor Applicability			Author Larry Goelz	Rev 0
	14			Approval G. Chaisson	Date 9-21-72
					Cross Reference

<u>Equipment</u>	<u>Change</u>	<u>Priority</u>	<u>Units Affected</u>	<u>Purpose</u>	<u>Indications of Accomplish</u>
BY14-DA (Output Box)	BY14DA 00002	MANDATORY	BY14DA S/N 317 & Prior	connects GNDs & +5V pins to form runs	Presence of wire from A04C to B01C in BY14.
K161 (Decoder)	K161 00001	MANDATORY	All etch Rev.A K161 boards	Provides reference For Q7 and Q8	Board is etch Rev "B" or higher, or R8 and R9 have been removed from Rev.A board.
	K161 00002	OPTIONAL	Etch Rev K161 Modls	Defeats noise on address lines	Module is etch revision D or higher
K207 (Flip/ Flop)	K207 00001	Low (Phase-in)	All etch Rev.A K207 boards	Eliminates unreliable operation at low temperature	Board is etch revision B or higher

Title DOCUMENTATION LIST						Tech Tip Number BY14-DD-TT-1		
All	Processor Applicability					Author Larry Goelz	Rev 0	Cross Reference
	14					Approval G. Chaisson	Date 9-21-72	

The following is a list of documentation available for the BY14-DD

DESIGNATOR	DESCRIPTION
UA-BY14-DD-0	Unit Assembly Drawing
BS-BY14-DD-1	Block Schematics
PL-BY14-DD-0	Parts List
CS-K135-0-1	Circuit Schematic K135
CS-K161-0-1	Circuit Schematic K161
CS-K207-0-1	Circuit Schematic K207
CS-K657-0-1	Circuit Schematic K657

Title ECO/ FCO						Tech Tip Number BY14-DD-TT-2		
All	Processor Applicability					Author Larry Goelz	Rev A	Cross Reference
	14					Approval G. Chaisson	Date 9-21-72	

Equipment	ECO Change	Priority	Units Affected	Purpose	Indications Of Accomplishment
K161 (Decoder)	K161 00001	MANDATORY	All etch Rev. A K161 boards	Provides for Q7 and Q8	Board is etch Rev. "B" or reference higher, or R8 and R9 have been removed from Rev. A board.
	K161 00002	OPTIONAL	Etch Rev C K161 Modules	Defeats noise on address lines.	Module is etch revision D or Higher
K207 (Flip/ Flops)	K207 00001	Low (Phase In)	All etch Rev.A K207 boards	Elimin- ates unreliable operation at low temperature	Board is etch Rev B or higher
K657 (DC Out- put module)	K657- 00001	Mandatory for units using DC outputs	All etch Rev.A K657 modules	Changes neons to light emitting diodes and changes black terminal strip to blue for rapid iden- tification of DC module.	K657 is etch Rev. B or higher, identified by blue terminal strip

Title INSTALLATION TESTS OF DC I/O BOXES						Tech Tip Number BY14-DD-TT-3		
All	Processor Applicability					Author L. Goelz	Rev 0	Cross Reference
						Approval G. Chaisson	Date 8/1/73	

For installation tests of DC 0-Boxes refer to Tech Tip BX14-DD-TT-3.

-- NOTES --

-- NOTES --

	FIELD SERVICE TECHNICAL MANUAL				Option or Designator
	12 Bit <input checked="" type="checkbox"/>	16 Bit <input checked="" type="checkbox"/>	18 Bit <input checked="" type="checkbox"/>	36 Bit <input type="checkbox"/>	CABINETS

Title					Tech Tip	
FAN DIRECTIONS					Number	TT#1
All	Processor Applicability			Author	Rev	Cross Reference
X				J. Blundell	g	
				Approval	Date	
				Frank Purcell	11/2/73	

Some standard cooling practices have evolved in the past with DEC equipment which are worth summarizing briefly to help you make field decisions when field installing extra cabinets and options.

Equipment cooling is accomplished in two ways:

1. Keeping the cabinet interior ventilated with cool, clean air.
2. Ensuring that each option gets a share of the cabinet air.

Point 1 used to be handled by sucking air through a metal filter on the cabinet floor, and blowing it upwards. This idea has generally been dropped now in favor of one (or two) fans on the cabinet roof sucking air down through a plastic foam filter placed on top of the cabinet. This system suffers from two disadvantages. One is that it is bucking not only the natural flow of hot air (which would be upwards), but also the flow of fans used in some cabinet mounted equipment. The pressure gradient caused by the hot air attempting to rise is easily overcome (especially with two fans blowing) and the individual equipment fans blowing upwards may well cause a beneficial agitation of the main air flow within the cabinet.

The second disadvantage is that the practice has never been officially standardized or checked for, resulting in multicabinet systems existing where one cabinet's fans blowing down may be balanced out by adjacent cabinets fans blowing upwards. The danger also exists that systems with all their fans blowing upwards are steadily filling their cabinet interiors and the logic with dirt.

The major advantages of roof mounted fans are:

1. Filters are easier to clean, with no danger of disturbing equipment.
2. Possibility now exists for using multiple fans.
3. More floor space for cabling.
4. Cleaner air is available from the top, and the floor under the system tends to stay cleaner.
5. The fans mount in "dead" space behind the logo, rather than use up floor level 19" rack mount space.

The cooling of individual logic assemblies within a cabinet will generally be done by a number of boxer type fans devoted to the logic assembly. Black boxes (such as the PDP8E) which have a primarily horizontal airflow will by convention move their air from right to left, as viewed from the front of the cabinet. It is good practice to check these fans at installation time and regularly thereafter to see that they are working freely, and also that they are all blowing in the correct direction.

Title						Tech Tip	
CABINETS						Number	
All Processor Applicability						TT#1	
Author J. Blundell						Rev 0	
Approval F. Purcell						Date 11/2/73	
X						Cross Reference	

It is not so critical which direction (up or down) individual logic rack fans are blowing but they should blow at the logic, rather than suck at it. (i.e. fans mounted above the logic should blow downwards and fans below should blow upwards,) unless two sets of fans have been used in a push/pull arrangement.

The primary point to remember on the field when integrating a system is that whatever cools the system best is right. Given a unique field situation with some cabinets effectively blocked up with devices such as RF08 type disk units, and some high wattage interfaces, it may well be that some fans will need to be reversed, or even that some additional fans may be required, but beware of jumping to the conclusion that whatever solved that unique problem is a cure all for other problems although if you do find recurring situations requiring similar solutions a written input to Maynard Product Support will be discussed with Mechanical Engineering and may lead to an ECO to improve the situation.

digital	FIELD SERVICE TECHNICAL MANUAL				Option or Designator
	12 Bit <input checked="" type="checkbox"/>	16 Bit <input checked="" type="checkbox"/>	18 Bit <input checked="" type="checkbox"/>	36 Bit <input checked="" type="checkbox"/>	CABLING RULES to CABLE

Title				Tech Tip		CABLING RULES	
RULES FOR CABLE USAGE				Number		TT-1	
All		Processor Applicability		Author	Don White	Rev	0
		8 8S 8I 8E 8L		Approval	W Cummins	Date	07/31/72
						Cross Reference	

Rule #1

Round and flat coax are electrically interchangeable, and may be intermixed in a system. Round coax is preferable for interconnecting free-standing cabinets, since it is far more resistant to the elephant-like feet of computer operators.

Rule #2

Ribbon cable and unshielded flexprint are "for the birds". Any person using such a cable on an 8-Family I/O bus does so at his own peril, and had better not get caught.

Rule #3

The maximum length of coax which may be used on the programmed I/O bus is 50 ft.

Rule #4

The maximum length of coax which may be used on the data-break bus is 30 ft.

Rule #5

Indiscriminate intermixing of shielded flexprint and coax is not advised. For consistency, and minimum cost, we recommend all cables be shielded flexprint unless used to interconnect free-standing cabinets, or to gain maximum length. No more than one change from flexprint to coax (or vice-versa) is permitted over the length of a bus.

Rule #6

Shielded flexprint (flexprint cables with alternate solid flexprint) can be used in place of coax. Shielded flexprint should be used only within cabinets, or in locations where it will not be subject to physical abuse (see rule #1).

Rule #7

Maximum permissible length of shielded flexprint is 45 ft. for programmed I/O, and 25 ft. for data break.

Rule #8

A DM01 = 10 ft. of cable (data break only) in rules #4 and #7.

A DM04 = 5 ft. of cable (data break only) in rules #4 and #7.

A DW08 (either A or B) equals 10 ft. of cable in rules #3, #4, and #7.

For DM01 and DM04, rules #4 and #7 refer to the sum of cable lengths from the processor to the DM and from the DM to the most distant break device.

Title RULES FOR CABLE USAGE (cont.)					Tech Tip Number TT-1	
All	Processor Applicability			Author Don White	Rev A	Cross Reference
8's				Approval W. Cummins	Date 7/31/72	

Rule #8 (continued)

In the case of the DW08A or B, positive and negative buses must be considered separately. For one of these buses (the one originating in the computer) rules #3, #4, and #7 should be applied directly. For the other bus, rules #3, #4, #7 and #8 govern the sum of the lengths of cable from the computer to the DW08 and from the DW08 to the most distant peripheral on the bus of opposite polarity.

Rule #9

Termination is required on programmed I/O cables longer than 20 ft., and may be desirable on shorter cables. For negative bus, use 220 ohm shunt resistors to ground on IOP 1, IOP 2, IOP 4, BTS 1, BTS 3 and Initialize. No special termination module exists for negative bus. For positive bus, 100 ohms to ground on the same lines should be used. (A G717 module does this for you, and should be inserted at the end of the bus on cable #1.) If two buses are present in a machine, they are electrically independent, and must be separately terminated.

Rule #10

No branching ("Y" connections) is permitted on the bus.

Title USE OF COAXIAL CABLE IN PDP-12's					Tech Tip Number Cable-TT-2	
All	Processor Applicability			Author	Rev 0	Cross Reference
12				Approval H. Long	Date 8.17.72	

Your attention is called to drawing D-AR-PDP-12-0-2 sheet 4 (Equipment Layout (PDP12)). Note 3 specifies that all systems with data break devices must be cabled with coaxial cable only. This should be strictly adhered to.

Title POSSIBLE INTERMITTENT BERG CONNECTOR PROBLEMS					Tech Tip Number Cable-TT-3	
All	Processor Applicability			Author Bill Perkins	Rev 0	Cross Reference
X				Approval	Date 6/27/74	

There is a possibility of intermittent connections with the berg male cable connector (DEC Part #12-10918-15).

The part causing the problem is the female connector pin (DEC Part #12-10089-06). Near the open end of this female pin there is a leaf spring. This leaf spring is held in place by two crimps at either end of the spring. Should either one of these crimps become loose or broken, the resulting pin connection may be intermittent or lost entirely. This is due to the leaf spring coming loose or falling out.

This problem is most likely to occur when the connector (or the cable attached to it) is subject to excessive mechanical stress or abuse.

GREATLY MAGNIFIED FEMALE PIN

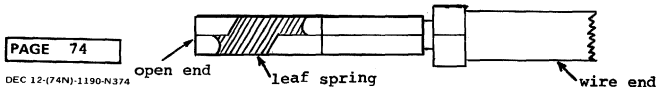

digital	FIELD SERVICE TECHNICAL MANUAL				Option or Designator
	12 Bit <input checked="" type="checkbox"/>	16 Bit <input type="checkbox"/>	18 Bit <input type="checkbox"/>	36 Bit <input type="checkbox"/>	CABLES

Title STANDARD CABLE USAGE FOR 8E OPTIONS					Tech Tip Number CABLE-TT-4		
All	Processor Applicability				Author Dale Staupe	Rev #	Cross Reference
	8E				Approval Jeff Blundell	Date 8/8/74	

OPTION	QTY.	PART #	OPTION	QTY.	PART #
AD8EA	1	70-8533	KL8-JA*	1	BC05-M
AM8EA	1	70-8533	KL8-JA*	1	70-8360
BA8	1	70-6993	KL8M	1	BC05C-25
BA8	1	70-8288-3F	KL8M	1	BC08T-1
BA8 (PDP8E)	2	BC08H-3F	KP8E	1	70-7128
BA8 (PDP8M)	2	BC08H-4F	KV8E	3	BC08J-06
BE8A	2	M935	KV8E	1	70-6289
BE8A	1	70-6993	LC8E	1	70-8417
CM8E	1	70-7252	LE8	1	70-6964
CM8F	1	70-8738	LT33MB 12ft	1	70-6593-1
CR8E	1	70-7252	LT33MB 18ft	1	70-6593-2
CR8F	1	70-8738	LS8E	1	70-8859
DB8EA	1	BC08R-25	PC8E	2	BC08K-6
DB8EB	2	BC08R-10	PP8E	1	BC08K-6
DK8EA	1	70-7128	PP67C to PA63	1	BC01P-25
DP8EA	1	BC05C-25	PR8E	1	BC08K-6
DP8EB	1	BC01V-25	RK8E/8F	2	70-09026
DR8EA	1	BC08S-1	RK01X to RK01	1	70-06604
DR8EA	2	BC08J-10	TA8	2	BC08R-10
DR8EB	2	BC08R-8	TD8E	1	70-8447
DR8EC	1	BC08S-1	TMS	2	BC08L-10
DR8EC	2	BC08R-8	VC8E	1	BC01L-10
DW8E (Neg)		BC08D-7			(Also see VC8E-TT-2)
DW8E (Pos)		BC08B-7	VR14	1	BC01K-10
KA8E	3	BC08J-10	VT05	1	H308 or H312
KD8E	2	BC08J-10	VT06	1	H308 or H312
KL8E/8F	1	70-8360	VT8E,EA	1	70-9042-15
KL8EA-KL8EG	1	BC01V-25	H721 to rear omnibus	1	70-09608
			XY8E	1	70-6965

* Not supplied with option

-- NOTES --

digital	FIELD SERVICE TECHNICAL MANUAL				Option or Designator
	12 Bit <input checked="" type="checkbox"/>	16 Bit <input type="checkbox"/>	18 Bit <input type="checkbox"/>	36 Bit <input type="checkbox"/>	CM12 CM8I

Title CM 12 (GDI Card Reader Only)				Tech Tip Number CM12-TT-1		
All	Processor Applicability			Author	Rev 0	Cross Reference
	12			Approval H. Long	Date 09/14/72	

Problem: "C.R.I." signal when reader is powered on or off, glitches to +2V and returns to +1V. This causes the PDP-12 interrupt bus to go true.

Correction: Do not power card reader up or down with software in operation.

/mt

Title GDI 100M RANDOM HALTS				Tech Tip Number CM8I TT#1		
All	Processor Applicability			Author Steve Cline	Rev 0	Cross Reference
				Approval W. E. Cummins	Date 11/14/73	

CARD READER MODEL GDI 100M RANDOM HALTS

Due to the floating grounds of the GDI 100M, there is a lot of internal noise. Occasionally enough noise is induced on the signal LEAMP, to cause motion errors when no card is in the reader. This has the effect of "MOTOR ON -" to go high turning off the motor and "ON LINE X" to go false. To cure, place .01 microf cap pin A2-29A to ground.

-- NOTES --

digital	FIELD SERVICE TECHNICAL MANUAL				CPL Option or Designator
	12 Bit <input checked="" type="checkbox"/>	16 Bit <input checked="" type="checkbox"/>	18 Bit <input checked="" type="checkbox"/>	36 Bit <input checked="" type="checkbox"/>	COMPONENTS

Title	CHARACTERISTICS OF NEW (AXIAL LEAD) BYPASS CAP				Tech Tip Number	TT#1
All	Processor Applicability	Author	J. Blundell	Rev	g	Cross Reference
x		Approval	F. Purcell	Date	1/4/74	

There have been a number of questions from the field concerning the new style of bypass capacitor used on many of the M series boards for +5 volt decoupling by each I.C.

The major difference with the new capacitor is physical, it looks like a small glass body diode, although there are a few electrical changes summarized below:

	Disc Type	Axial Lead Type
Part #	10-01610-01	10-01610-00
Type	Ceramic disc	Monolithic
Capacitance (25°C)	8000pF min.	8000 pF min.
Lead Pull Test	5 lbs for 5 seconds	10 lbs.
Markings	Printed on body	Color bands (brown, black, orange)
Working Voltage	100 volts	50 volts
Insulation Resistance	10K Mohms minimum	5K Mohms minimum

Note that although there are some electrical difference between the two types of capacitor they are not relevant when the capacitor is being used as a chip decoupling capacitor. You may treat the two components as being interchangeable in the field should it be necessary to touch up a module whose disc capacitors have suffered damage. The axial lead capacitor is not polarity sensitive, it does not matter which end the color bands are on.

Title	DATE CODES OF SUSPECT COMPONENTS				Tech Tip Number	COMP-TT-2
All	Processor Applicability	Author	Jeff Blundell	Rev	g	Cross Reference
x		Approval	Frank Purcell	Date	8/6/74	

The following components are suspect, and should be purged from F.S. stockrooms and toolkits.

NAME	MANUFACTURER	DATE CODE	DEC #
2N3055	Motorola	7426	15-10008
2N3055	Motorola	7426	15-05819
Bridge Rectifier	NAE	Before 7339	11-10714

Notes

1/ The 1510008 is a 2N3055 with solder lugs crimped onto the base and emitter leads ready for use in the H724 (PDP8E power supply). The 15-05819 is the basic transistor.

2/ This bridge rectifier is used primarily on the PDP8M/PDP8F/PDP11/05 and 11/35 power supply. See ECO 54-09728-13.

Title										Tech Tip	
SELECTION OF COMPONENTS FOR USE WITH CRYSTALS										Number	
										COMPONENTS-TT-3	
All Processor Applicability					Author			Rev		Cross Reference	
X					Ralph Boehm						
					Approval			Date		M405-TT-2	
					Chuck Sweeney			9/18/74			

This Tech Tip is issued for cross reference purposes only.

digital	FIELD SERVICE TECHNICAL MANUAL				Option or Designator
	12 Bit <input checked="" type="checkbox"/>	16 Bit <input checked="" type="checkbox"/>	18 Bit <input checked="" type="checkbox"/>	36 Bit <input checked="" type="checkbox"/>	CR03

Title <i>CR03 NOISE PROBLEM</i>				Tech Tip Number <i>CR03-TT-1</i>	
All	Processor Applicability		Author <i>H. Fitek</i>	Rev <i>0</i>	Cross Reference
	<i>8</i>	Approval <i>W. Cummins</i>	Date <i>07/31/72</i>		

When the reader motor start switch is actuated, noise can be generated as relay K1 contacts close. The solution to this problem is to install a Thyrector across contact terminals #6 and #8 of K1.

*117V, 50Hz - Thyrector part # SP9B9 - \$3.66
117V, 60Hz - Thyrector part # SP4B4 - \$2.10*

Title <i>EXCHANGE OF 804 WITH CR03 INSTALLATION</i>				Tech Tip Number <i>CR03-TT-2</i>	
All	Processor Applicability		Author <i>H. Fitek</i>	Rev <i>0</i>	Cross Reference
	<i>8</i>	Approval <i>W. Cummins</i>	Date <i>07/31/72</i>		

PDP-8 ECO #256 specifies that any 804 logic below serial number 751 must be exchanged if a CR03 is to be added. A new 804 logic will be included with a field add-on CR03. There are no additional charges involved for the 804 exchange; the original 804 is to be returned to the factory.

Title <i>50 CYCLE CONVERSION OF CR03 GDI CARD READER</i>				Tech Tip Number <i>CR03-TT-3</i>	
All	Processor Applicability		Author <i>H. Fitek</i>	Rev <i>0</i>	Cross Reference
	<i>8</i>	Approval <i>W. Cummins</i>	Date <i>07/31/72</i>		

A 60 cycle CR03 can be converted to 50 cycle operation by the following procedure:

- 1) If the motor is rated 50/60 cycles it need not be changed. A 60 cycle motor, however, must be exchanged for one rated 50/60 cycles.*
- 2) The two timing belt pulleys must be changed from #24XL037 (two each) to #20XL637 (two each).*
- 3) Capacitor C4 (.0033 mfd.) on the 4017 module must be changed to 82mmfd. (68mmfd. is acceptable).*
- 4) The following adjustments must be made:*
 - a) decrease TP1 from 80msec. to 60msec.*
 - b) decrease TP2 from 180msec. to 166msec.*
 - c) TP3 should be unchanged, 20msec.*

Title GDI MODEL 100 CARD READER TECHNICAL MANUAL UNDOCUMENTED WIRING VARIATIONS						Tech Tip Number CR03-TT-4		
All X	Processor Applicability					Author John Breyer	Rev 0	Cross Reference
					Approval William Cummins	Date 02/16/73		

Reference: GDI Model 100 Card Reader Technical Manual,
Revised April 23, 1970, page 5-9, paragraph 5.8.1,
"Time Pulse Divider".

Line 7 says "...all counters except the 2 BIT in the T.P. Divider are reset to the count of zero each time a card enters the read station.", etc. This is wrong. The etch on the A-2 logic card is layed out so that the signal "T.P. Divider RESET" from A-10B to A2-4A and A2-29A will always clear all four (4) T.P. Divider flip-flops. Card column -1 will always get 16 counts, not 14 as stated in paragraph 5.8.1.

The note on Page 5-19, which is mentioned at the end of paragraph 5.8.1, is also completely wrong. The wiring change mentioned has nothing to do with "T.P. Divider Reset". The wire run mentioned in the note is shown on the wiring diagram (Drawing #D-10505) as A3-13 to A2-27A. The change described in the note makes this wire run A3-13B to A2-28A. This change will make the column pulse occur earlier in the 16 timing pulses per column.

The wire from A2-27A to A2-23A should not have been changed. However, anything is possible, so the only practical way to determine the T.P. Divider scheme for an individual GDI is to physically inspect the external wiring for the T.P. Divider, correlate that with the logic prints for the A2 and A3 cards (Drawing #'s D-0002, and C-4006) and draw the resulting timing diagram. From the timing diagram you can tell which of the 16 timing pulses per column will product the column pulse, and, therefore the index marker.

/mt

digital	FIELD SERVICE TECHNICAL MANUAL				Option or Designator
	12 Bit <input checked="" type="checkbox"/>	16 Bit <input checked="" type="checkbox"/>	18 Bit <input checked="" type="checkbox"/>	36 Bit <input checked="" type="checkbox"/>	CR#4

Title					DOCUMATION CARD READERS		Tech Tip Number	CR#4-TT-1
All	Processor Applicability				Author	W. Bruckert	Rev	g
X					Approval	W. Cummins	Date	12/08/72
								Cross Reference

In order to make control of ECO's easier for Field Service, Engineering is giving the Documation Card Reader's option numbers. You should change your parts lists to call out the following options in place of part numbers; ECO's will be written against the CR#4.

<u>Part Number</u>	<u>Option</u>
3#-1#639-#1	CR#4-A
3#-1#639-#2	CR#4-B
3#-1#639-#3	CR#4-C
3#-1#639-#4	CR#4-D
3#-1#639-#5	CR#4-E
3#-1#639-#6	CR#4-F
3#-1#639-#7	CR#4-H
3#-1#639-#8	CR#4-J

Title					HOPPER EMPTY SWITCH FAILURE		Tech Tip Number	CR04-TT-2
All	Processor Applicability				Author	G. Morrison/ N. Kelleher	Rev	A
X					Approval	Lou Nay <i>L</i>	Date	5-23-73
								Cross Reference

A high failure of the "Hopper Empty Switch" used on the documation card readers is due to the wrong type of switch being used. Possibly due to nomenclature used by documation for "Hopper Empty" and "Hopper Full".

Action: Check all units for the correct switch.

Change all references in the documation manual for "Hopper Full" to Stacker Full".

Order switches by Part Numbers.

As numerous part/part # changes have occurred, refer to CR04-TT-8 for switch assembly summary and cross-reference.

Title CROSS REFERENCE: DOCUMENTATION CARD READERS						Tech Tip Number CR04-TT-3	
All Processor Applicability		Author G. Morrison		Rev A		Cross Reference	
X		Approval Bob Yurick		Date 12/08/72			

The Documentation Card Reader, being a Cross Product Line device, results in different Part Numbers for particular assemblies e.g., modules. Part Numbers for the modules (vendor number) are marked on the ETCH side of the module as an "ASSY 610-03" for example.

NOTE: The revision level of the ETCH or the revision level of the component sides is not the part number.

To establish a standard on future bulletins the following will be used to flag a reference to a particular model of card reader:

MXXYY.DDD XX = Modle
 YY = Power Type
 DDD = Logic Type

e.g. M0260. GDI = M200 Model 60Hz with GDI Interface (pos. logic).
 e.g. M1250. MDS = M1200 Model 50Hz with MDS Interface (neg. logic).

MODULE CROSS REFERENCE

		DEC. #	VENDOR #
1.	M0260 GDI, M0250 GDI		
	Control	29-18511	1040619-05
	Clock	29-18510	1040765-05
	Sync	29-18513	1040353-03
	Error	29-18512	1040610-03
2.	M0260, MDS, M0250, MDS		
	Control	29-19490	1040845-01
	Clock	29-19491	1040765-03
	Sync	29-18513	1040353-03
	Error	29-19494	1040822-01
3.	M1060, MDS, M1050, MDS		
	Control	29-19490	1040845-01
	Clock	29-19491	1040765-03
	Sync	29-19493	1040353-05
	Error	29-19494	1040822-01
4.	M1260. MDS, M1250, MDS		
	Control	29-19490	1040845-01
	Clock	29-19491	1040765-03
	Sync	29-19492	1040353-02
	Error	29-19494	1040822-01

digital	FIELD SERVICE TECHNICAL MANUAL				Option or Designator
	12 Bit <input checked="" type="checkbox"/>	16 Bit <input checked="" type="checkbox"/>	18 Bit <input checked="" type="checkbox"/>	36 Bit <input checked="" type="checkbox"/>	CR04

Title DRIVE BELT TENSION ADJUSTMENT				Tech Tip Number CR04-TT-4	
All	Processor Applicability		Author J. Kelleher/H. Carney	Rev A	Cross Reference Documentation Card Reader
x			Approval W. Cummins	Date 04/03/73	

Drive Belt Tension Adjustment is a critical adjustment. Though the belt is notched and driven by a notched wheel should it be too slack it will cause deviation in card speed resulting in Read errors, usually only in columns 77-80, or if too tight it will cause excess bearing wear.

This procedure should be used as a check on the manuals procedure as this is specification for the belt tension.

Using a spring scale in the middle of the longest unsupported span of the drive belt 1/4 inches deflection of the belt should register 12-16 ounces on a spring scale.

Title STICKING INPUT HOPPER CARD FOLLOWER				Tech Tip Number CR04-TT-5	
All	Processor Applicability		Author R.K. Stannard	Rev g	Cross Reference Documentation Card Reader
x			Approval Lou Nay	Date 5-1-73	

Problems in which the Input Hopper Card Follower was not exerting enough force, causing the cards to tilt and intermittent pick checks have been reported on documentation M1000 readers.

Before assuming a weak coil spring is the culprit, the Follower Guide should be taken apart, flushed out with tape head cleaner and the bearings given a light coat of Oil. Card dust mixed with oil has been found in the Follower Guide in some cases. Following the above procedure will solve the problem.

Title						RECOMMENDED TOOLS FOR DOCUMENTATION CARD READERS		Tech Tip Number		CRO4-TT-6	
All		Processor Applicability				Author		J. Kelleher		Rev	
X						Approval		Lou Nay		Date	
								5-9-73		Cross Reference Documentation Card Reader	

The following tools are recommended for branch office tools. Due to their infrequent use, one set per branch should be more than enough.

AMP Extraction Tool	29-20666
AMP Leaf Contact Extraction Tool	29-20667
AMP Modified Fork Contact Extractor	29-20659
AMP Mod. IV Contact Extraction Tool	29-20660
Deutsch Insertion/Extraction Tool	29-20661
Elco Extraction Tool	29-20662
Elco Insertion Tool	29-20663
Spring scale (2 lbs)	29-20664
IC Test Clip	29-10246
Documentation Card Extender	29-19229

digital	FIELD SERVICE TECHNICAL MANUAL				Option or Designator
	12 Bit <input checked="" type="checkbox"/>	16 Bit <input checked="" type="checkbox"/>	18 Bit <input checked="" type="checkbox"/>	36 Bit <input checked="" type="checkbox"/>	CRO4

Title			READ HEAD/LIGHT STATION REPLACEMENT PROCEDURE		Tech Tip Number	CRO4-TT-7
All X	Processor Applicability		Author	J. Kelleher	Rev	g
			Approval	Lou Nay <i>LN</i>	Date	5-23-73
						Cross Reference

When replacement of a read head or light station is dictated, both read head and light station must be replaced per this procedure.

- Follow the procedure as detailed in the M series manual for the replacement of the read head and light station. Removing and replacing both read head and light station.
- Note that instead of the connector at the end of the light station cable there is an additional P.C. card. This card contains light station "select at test" resistors (S.A.T. Resistors).
- In order to supply +5 volts to the in-line P.C. card one of the old light station resistors must be jumpered. Using the power supply view attached as a reference solder a jumper across R9.
- Plug the P.C. board into power supply. Reader is now ready to operate.
- The read head and light station are ordered as a kit and should stay together. The part numbers for ordering are:

29-20622	M200
29-20623	M300,600,+1000
29-20624	M1200

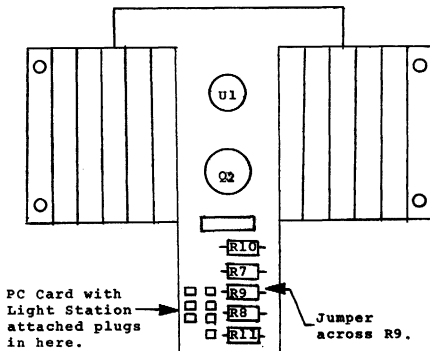

(Power Supply View)

Title						DOCUMATION SWITCH ASS'Y SUMMARY AND CROSS REFERENCE		Tech Tip Number		CR04-TT-8	
All		Processor Applicability				Author J. Kelleher		Rev A		Cross Reference	
X						Approval Lou Nay <i>ln</i> Date		5-23-73			

The following cross-reference is intended to eliminate any part number confusion and update Tech Tip CR04-TT-2.

A. Hopper Empty Switch Assembly

M200/M100/M1200:	Old Vendor Number	1020277
	New Vendor Number	20027701
	DEC Number	29-18523

B. Hopper Empty Switch

M200/M1000/M1200:	Manufacturers Number	E21-85HX
	Old Vendor Number	E21-85HX
	New Vendor Number	00000313
	DEC Number	29-18524

C. Stacker Full Switch Assembly

	<u>M200</u>	<u>M1000</u>	<u>M1200</u>
Old Vendor Number	1120551	1020211	1320702
New Vendor Number	00000313	20021101	20070201
Dec Number	29-18524	29-19619	29-19634

D. Stacker Full Switch

	<u>*M200</u>	<u>M1000</u>	<u>*M1200</u>
Old Mfg Number	E34-85HX		E34-85HX
New Mfg Number	E21-85HX	E63060K	E21-85HX
Old Vendor Number	E34-85HX	E63060K	E34-85HX
New Vendor Number	00000313	00000314	00000313
Dec Number	29-18524	29-19487	29-18524

*A vendor change has changed the old type switch to the new type switch.

digital	FIELD SERVICE TECHNICAL MANUAL				Option or Designator
	12 Bit <input checked="" type="checkbox"/>	16 Bit <input checked="" type="checkbox"/>	18 Bit <input checked="" type="checkbox"/>	36 Bit <input checked="" type="checkbox"/>	CR04

Title BEARING AND SHAFT REPLACEMENT				Tech Tip Number CR04-TT-9	
All		Processor Applicability		Author Joe Kelleher	
X				Rev A	
Approval Lou Nay <i>Lou Nay</i>				Date 9-1-73	
Cross Reference					

Certain shafts and bearings require replacement as a matched set and should be ordered as such. The effected parts and their location are given below for easier indentification:

When replacing any shaft or bearing, seriously consider replacing both whether they come as matched sets or not. Because of the wear between the old pieces, replacing just one will cause the new piece to fit loosely and wear sooner than if both bearing and shaft had been replaced.

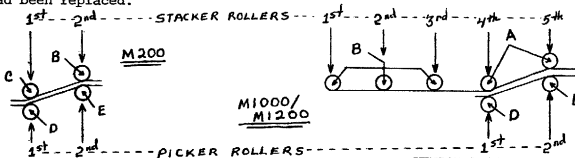

FIND #	UNIT/S	DESCR	VENDOR BEARING AND SHAFT ASS'Y #	DEC P/N
A	M1000 M1200	4th and 5th STACKER ROLLERS	000 008 71	29-20283
B	M1000 M1200	1st,2nd,3rd,STACKER ROLLERS	000 008 72	29-20284
	M200	2nd STACKER ROLLER	000 008 72	29-20284
C	M200	1st STACKER ROLLER	000 008 70	29-20282
D	M200/ M1000/ M1200	1st PICK DRIVE ROLLER	000 015 13	29-20918
E	M200 M1000/ M1200	2nd PICK DRIVER ROLLER	000 015 14	29-20919

Title SOLID STATE RELAY				Tech Tip Number CR04-TT-10	
All		Processor Applicability		Author R.J. Maloney	
X				Rev A	
Approval Lou Nay <i>Lou Nay</i>				Date 9-1-73	
Cross Reference					

Old Documentation Card Readers used to use one of two different relays. One for 120/60 Hz and another for 240/50 Hz. Both are replaced by the same type DEC #29-18520. This is a direct replacement and need not be done unless the old relay fails.

Title						Tech Tip		CR04-TT-11			
READ CHECKS - 81 COLUMN CARDS						Number					
All		Processor Applicability				Author		Rev		Cross Reference	
X						J. Kelleher		Ø			
						Approval		Date			
						Lou Nay		12/3/73			

IBM and a few other companies have started to punch 81 columns in their cards. At present, this will cause a "read check" in our card readers because they are wired to do a "dark check" on column 81. But we have a way around this. On the clock card between IC's C1 and C2 there is a resistor R9 and two holes where a jumper can be put. Placing this jumper will simply eliminate the "dark check" on column 81 so cards with 81 column punched should now read.

Title						Tech Tip		CR04-TT-12			
A PREDOMINANT CAUSE FOR READ CHECKS AND DATA ERR						Number					
All		Processor Applicability				Author		Rev		Cross Reference	
X						J. Kelleher		Ø			
						Approval		Date			
						Lou Nay		12/3/73			

Should you be plagued with read checks not due to 81 column cards and/or DATA ERRORS, and to your knowledge the logic is ok and the cards are not punched out of skew or alignment. Consider the rubber picker rollers (4) because should they be worn enough they will deskew the card enough to cause the errors. Check to see if there is a gap between the picker rollers and the metal stacker rollers. If there is, replace the picker rollers (4) but realize that if there isn't a gap that doesn't eliminate the possibility that the picker rollers wear isn't to blame.

Title						Tech Tip		CR12-TT-1			
GDI MODEL 100 CARD READER TECHNICAL MANUAL						Number					
UNDOCUMENTED WIRING VARIATIONS											
All		Processor Applicability				Author		Rev		Cross Reference	
X						John Breyer		0			
						Approval		Date			
						W. Cummins		02/16/73		CR03-TT-4 (CPL)	

digital	FIELD SERVICE TECHNICAL MANUAL				Option or Designator
	12 Bit <input checked="" type="checkbox"/>	16 Bit <input type="checkbox"/>	18 Bit <input type="checkbox"/>	36 Bit <input checked="" type="checkbox"/>	CR8I

Title CR8I TECH TIP				Tech Tip Number CR8I-TT-1		
All Processor Applicability				Author Chuck Sweeney	Rev 0	Cross Reference
8I	12			Approval W. Cummins	Date 07/31/72	

There is a problem with the CR8I in a certain application; the following simplified program will demonstrate the fault.

```

7000 6672 Skip if reader ready; pick card
7001 5200 Look for reader ready
7002 6671 Skip if card done
7003 5202 Look for card done
7004 5200 Get next card

```

SUPPLEMENTAL ACTION TAKEN

The problem application involves the operator ~~ECO~~ ^{M714 001} filling the input hopper of the reader, (2) pressing motor start and read start on the reader, (3) loading and starting 7000 on the monitor. Cards will begin to be processed and after the last card has been processed the program will hang up in the loop looking for READER READY. The operator now repeats steps 1, 2, and 3 and if everything were right the cards would be processed.

OBSOLETE

The problem is that when motor start is activated, there is enough noise on the READER READY line to cause an erroneous SKIP ON READER READY. Consequently, the program may hang up looking for CARD DONE.

A temporary fix, which will only apply to customers using this scheme of operation, is to install a .01uf capacitor from pin R2 on the M714 module to ground. A formal ECO to the module is being generated as the permanent method of solution of this problem.

Title CARD READER MODEL GDI 100M RANDON HALTS CM8I, CM8L, CM8E				Tech Tip Number CR8I-TT-2		
All Processor Applicability				Author Steve Kline	Rev 0	Cross Reference
8E	8I	8L	12	Approval Bill Cummins	Date 07/31/72	

Due to the floating grounds of the GDI 100M, there is a lot of internal noise. Occasionally enough noise is induced on the signal LEAMP, to cause motion errors when no card is in the reader. This has the effect of "MOTOR ON -" to go high turning off the motor and "ON LINE X" to go false. To cure, place .01 microf cap pin A2-29A to ground.

CR8I-TT-3 (Continued)

EFFECTS OF MODIFICATION ON GDI LOGIC

GDI PRINT AE

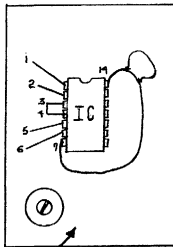
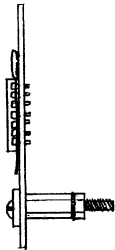
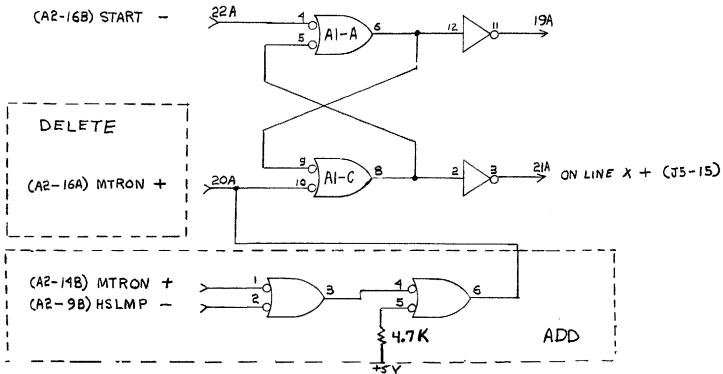

PIN 1	A2-19B
PIN 2	A2-9B
PIN 3	PIN 4
PIN 5	+5V
PIN 6	A6-20A
PIN 7	GND
PIN 14	+5V

capacitor across IC pins 7 & 14
(.01 μ F, disc, 100V)

perforated, un-clad printed circuit board
(e.g. section of W999 module) *

IC = MCB46P or DT μ L94659
(DFC STK # 29-16293)

* the above assembly can be mounted on the GDI motor bracket
Page 92

digital	FIELD SERVICE TECHNICAL MANUAL				Option or Designator
	12 Bit <input checked="" type="checkbox"/>	16 Bit <input type="checkbox"/>	18 Bit <input type="checkbox"/>	36 Bit <input checked="" type="checkbox"/>	CR8I

Title GDI MARK SENSE CARD READER				Tech Tip	
Improper Operation of Reader Ready Logic				Number CR8I-TT- 3	
Processor Applicability			Author Chuck Sweeney	Rev 0	Cross Reference
All	<input checked="" type="checkbox"/>	<input checked="" type="checkbox"/>	Approval Bill Cummins	Date	

The following program will illustrate the problem:

```

7400/6672
7401/7402 - Program should HALT when last card has been processed
7402/6671
7403/5202
7404/5200

```

PROBLEM: In the MARK SENSE card reader, a signal called MTRON + is used to reset the ON-LINE X flip-flop (the status of this flip-flop is sampled by our control logic to determine if the card reader is capable of processing another card).

The time span from when the last card leaves the input hopper (Hopper Empty signal), until MTRON + goes false (resetting the ON LINE X flip-flop), is so long that the reader will appear to be ready even though there are no more cards to be read. (under these conditions, the program above will loop around locations 7402 and 7403)

SOLUTION: The only way to correct the problem is to OR the Hopper Empty signal with MTRON + and use the resultant signal for resetting ON LINEX: this can only be accomplished by adding an external component to the existing GDI logic.

The following diagrams will explain the exact nature of the modification.

See drawing, page C.

Title GDI MOD 100 CARD READER CHANGES						Tech Tip Number CR8I-TT-4				
All	Processor Applicability					Author	Bob Nunley	Rev	0	Cross Reference
	8I	12				Approval	Bill Cummins	Date	07/31/72	

Several General Design Inc., Engineering notices have been generated on their Mod 100 and Mod 500 card readers. Included is the package of electrical EN's which may be incorporated in the field by DEC if problems are observed. Although not all EN's give a problem-cure statement, a general statement is included so that the problem-cure may be deduced.

Format of Synopsis:

Date of / En Number / Revision / Assembly Name / Problem-Cure
GDI Break-In / / / & Number /

Breakdown of symbols:

A3A11-4 = Card A3
IC A11
Pin 4

A3-22A = Pin 22A
Card A3

XA3-22A = Wire Side Slot A3
Pin 22A

EN Number refers to a drawing.

DEC # = DEC Part Number.

I. Wiring Plane

10-14-68/EN-10505/B/Wiring - Mod 100/Provide variable lamp
intensity.

Add R101 (80pot) in series with positive lead to read lamp connector.
Wiper to GND - one end to J101-B other end is not connected.

To adjust:

- 1) Disconnect read/head connector.
- 2) Turn on reader.
- 3) Using a 500 micro-amp meter, measure and record the short circuit current of each Photocell Negative lead to Pin 13.
Positive Lead to each Photocell in turn.
- 4) Adjust lowest output to 300 - 350 micro-amps.

PAGE 94	PAGE REVISION 0	PUBLICATION DATE July 1972
---------	-----------------	----------------------------

digital	FIELD SERVICE TECHNICAL MANUAL				Option or Designator
	12 Bit <input checked="" type="checkbox"/>	16 Bit <input type="checkbox"/>	18 Bit <input type="checkbox"/>	36 Bit <input checked="" type="checkbox"/>	CR8I

CPL

Title GDI MOD 100 CARD READER CHANGES (Continued)				Tech Tip CR8I-TT-4 Number	
All	Processor Applicability		Author Bob Nunley	Rev 0	Cross Reference
8I <u>2</u>			Approval Bill Cummins Date		

11-11-68/EN-D-10505/C/Wiring - Mod 100/Prevent transients on motor start from setting flip-flops and producing false index markers.

Add three IN270 diodes to slot A3 (DEC #11-00117)

Anode to XA3-3A, XA3-6A, XA3-8B

Cathodes to XA3-18B

Number CR10, CR11, CR09 respectively

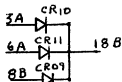

7-28-69/EN-D-10505/F/Wiring - Mod 100/

- 1) Prevent stacker from interrupting current pick cycle.
- 2) Improve pull up time of hopper empty signal.

- 1)
 - A) Add IN270 diode between XA4-29B (anode) and XA5-16A (cathode).
 - B) Add 4.7K ohm 1/2W res. between XA4-29B and +5 volt bus.
- 2)
 - A) Add IN270 diode between A4-30B (anode) A5-16A (cathode).
 - B) Add 4.7K ohm 1/2W res. between A4-30B and +5 volt bus. IN270 DEC #11-00117

2-13-70/EN-D-10505/H/Wiring - Mod 100/Enable reader to stack a card that has a leading edge dark check.

- 1) Delete XA5-9A to XA4-22A.
- 2) Add XA5-9A to XA4-14A.
- 3) Change A5-9A name from S.O. & N.O. to CIRI.

2-13-70-EN-D-10505/H/Wiring - Mod 100/eliminate erroneous "Sync Fail" condition when hopper empty or stacker full is cleared.

Wires:

- 1) Delete XA4-18A to XA3-29B
- 2) Add XA4-18A to XA5-22A
- 3) Change A4-18A name from Composite Error to R.D.Y.

Title GDI MOD 100 CARD READER CHANGES (Continued)				Tech Tip Number CR8I-TT-4		
All	Processor Applicability			Author Bob Nunley	Rev 0	Cross Reference
	8I	1A		Approval Bill Cummins	Date	

II Solenoid & Indicator Drivers (A5)

2-3-69/EN4012/A/4014 Solenoid and Indicator Drivers (A5) reduce voltage on associated lamps to 14V. (No need to field retrofit.)

Change resistors from 47 ohms to 75 ohms on A5 - R11, R13, R15, R19, R21, Mod 100 & Mod 500.

Model 500 Drawing D4000 R6, R7 (DEC #13-05281 = 75 ohm)
Model 100 Wiring R4, R5

- 1) Provide a non-recoverable error signal to J5-18 (output connector to computer).

Adds an IC. Changes part number of P.C. board to 4013A. Cannot field retrofit P.C. board. When new module is installed, add XA5-15B to J5-18 NRE (drawing 1).

- 2) Keep ready signal high until read cycle complete.

See (1) above.

With new board:

Add XA4-14A to XA5-25B $\overline{CIR1}$

Add XA3-2A to XA5-26B PICK FF

Drawing 2

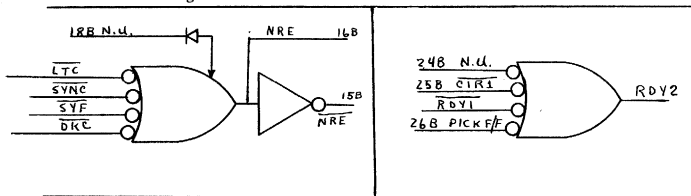

III. Power Supply

3-17-68/EN-B-10502/B-C/Power Supply/

Change components
FROM

TO

REV. B	R2	91 ohm	120 ohm (DEC #13-00243)
	C1	12000 microf 10V	13000 microf 15V (DEC #10-09436)
	T1	Part number 12.8-8	Signal #5864
REV. C	Q1, Q2	TIP14	2N5055 (DEC #15-05819)

PAGE 96	PAGE REVISION 0	PUBLICATION DATE July 1972
---------	-----------------	----------------------------

Title GDI MOD 100 CARD READER CHANGES (Continued)				Tech Tip Number CR8I-TT- 4		
All	Processor Applicability			Author Bob Nunley	Rev 0	Cross Reference
	8I			Approval Bill Cummins	Date	

III. Power Supply (continued)

10-29-69/EN-B-10502/D/Power Supply

Add thyrector (CR7) between J3-2 & J4-7

GE #6RS205P4B (DEC #11-00106)

2-19-69-/EN-B-10502/E/Power Supply/By pass line transients

Add dual .1 uf capacitor to power supply (C4A, C4B)

Sprague #DYR6011J (DEC #10-02153)

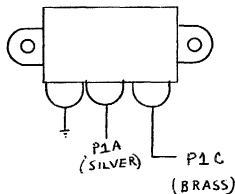

6-5-69/EN-1052/F/Power Supply/Improve +5 Volt regulation

Change R1

From	To
62 ohms 1/2 Watt 5%	33 ohms 1 Watt 5% (DEC #13-04831)

IV. Control and Error Detectors (A3)

10/14-68/EN-4006/B/C & E DET. (A3)Occasionally the CIRI F/F does not set when a card enters the Read Station. This will cause a false light check. To eliminate:

Add IN457 diode between A3A8-11 (cathode) and A3A7-12 (anode)

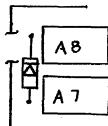

WAS

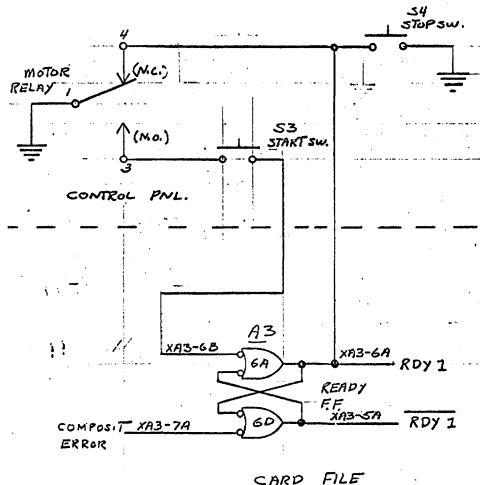

IS

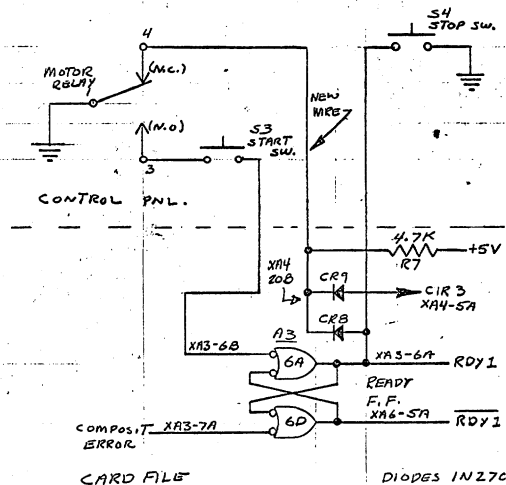

THIS WIRING CHANGE WILL PREVENT ANY SIGNAL OUTPUT FROM THE "CIR 3" (CARD IN READER SIGNAL) WHEN POWER IS TURNED ON. CRB PROVIDES THE RESET TO THE READY FF FROM THE MOTOR RELAY AND ISOLATES THE STOP SWITCH. CR9 PROVIDES THE CIR 3 CLAMP LOW DURING POWER ON AND WILL HOLD THE LINE LOW UNTIL THE MOTOR IS STARTED. R7 PROVIDES A PULL UP TO REVERSE BIAS CRB & CR9 WHEN THE MOTOR RELAY OPERATES. THIS CHANGE REQUIRES AN ADDITIONAL WIRE FROM THE CONTROL PANEL TO THE CARD FILE. CONNECTOR XA4 PIN 20B MAY BE USED AS A TIE POINT FOR THE WIRE, CRB, CR9 AND R7.

MODEL 100 READER
CIR 3 INHIBIT CIRCUIT.

J. FERGUSON

digital	FIELD SERVICE TECHNICAL MANUAL				Option or Designator CR8I
	12 Bit <input checked="" type="checkbox"/>	16 Bit <input type="checkbox"/>	18 Bit <input type="checkbox"/>	36 Bit <input checked="" type="checkbox"/>	

Title GDI MOD 100 CARD READER CHANGES (Continued)				Tech Tip Number CR8I-TT-4		
All	Processor Applicability			Author Bob Nunley	Rev 0	Cross Reference
	8I	12		Approval W. Cummins	Date	

IV. Control and Error Detectors (A3) (continued)

10-18-68/EN-4006B/C & E DET (A3)/Eliminate false "Stacker Fail" indications.

- 1) Short C2 with a jumper wire on back side of P.C. board.
- 2) Cut printed circuit on front of board between C2 and A3A11-6.

4-18-68/EN-C-4006/C & E DET (A3)/Provide stacker jam detection after one card. (If A3 number is 4008-101, this mod has already been made.)

On the A3 module:

- 1) Open all printed circuits attached to All pins 4, 5, & 6.
- 2) Jumper A3A11-4 to A3-22A.
- 3) Jumper A3A11-5 to A3-21A.
- 4) Jumper A3A11-6 to A3-20A.
- 5) Drill P.C. Board for 6.8K 1/4 W resistor (DEC #13-00463).
- 6) Solder one lead to A3A11-4. The other end solder to +5 volt and from A3-31A.
- 7) Add 101 after assembly.
- 8) This redesigns the stacker fail circuit and creates an extra "and" gate in A3A11.

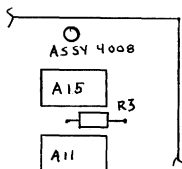

Title GDI MOD 100 CARD READER CHANGES (Continued)					Tech Tip Number CR8I-TT-4		
All	Processor Applicability				Author Bob Nunley	Rev 0	Cross Reference
	81	/A			Approval W. Cummins	Date 07/31/72	

GDI MOD 100 CARD READER CHANGES (continued)

V. One Shots (A-4)

4-18-69/EN-C-4009/one shots (A-4)/Provide faster recovery for S.O. one shots. (This mod has already been made if assembly number is 4010-101.)

1) Drill P.C. board for 1.0K resistor (DEC #13-0036-5).

Solder leads to A4-22A and +5land from A4-31A.

2) Add 101 after assembly number; i.e., 4010-101.

2-13-69/EN-4009/D/One Shots (A4)/ On rare occasions a "light check" is indicated as the last card is read. By pass switching transients in Mod 100 and Mod 500 readers.

On A4:

1) Add a 2500 PF 10V cap between A4-28A and ground.

2) Show cap on drawing C-4009, designation as C17.

Robert Nunley/February 1971

Title GDI MODEL 100 CARD READER TECHNICAL MANUAL UNDOCUMENTED WIRING VARIATIONS					Tech Tip Number CR8I-TT-5		
All	Processor Applicability				Author John Breyer	Rev 0	Cross Reference
	X				Approval W. Cummins	Date 02/20/73	

Title GDI MODEL 100 CARD READER TECHNICAL MANUAL UNDOCUMENTED WIRING VARIATIONS					Tech Tip Number CR8L-TT-1		
All	Processor Applicability				Author John Breyer	Rev 0	Cross Reference
	X				Approval W. Cummins	Date 02/16/73	

digital	FIELD SERVICE TECHNICAL MANUAL				Option or Designator CTS
	12 Bit <input checked="" type="checkbox"/>	16 Bit <input checked="" type="checkbox"/>	18 Bit <input type="checkbox"/>	36 Bit <input type="checkbox"/>	

Title MISSING ADJUSTMENT PROCEDURE FOR PUNCH MAGNET.				Tech Tip Number CTS-TT-1	
All 8	Processor Applicability			Author S. LAMOTTE	Rev 0
	11			Approval S. LAMOTTE	Date 5/10/74
					Cross Reference

Adjust when necessary, or after any punch magnet has been replaced.

1. Loosen the acutator coil locking screw (long screw thru center of all punch magnets). This will allow the magnets C cores a little play in their position.
2. Rotate crank shaft until timing dial is set to 130 degrees. All amatures should be flush against their respective C cores.
3. Turn machine power on, and push each armature coil so they are tight against the punch armature.
4. Tighten the acutator coil locking screw.

To check adjustment, place a card in the punch station, and rotate crank-shaft thru a cycle, no hole should be punched.

Decision data is in final checkout of the new adjustment procedure, which corrects this deficiency.

-- NOTES --

digital	FIELD SERVICE TECHNICAL MANUAL				Option or Designator DATA COMMUNICATIONS
	12 Bit <input checked="" type="checkbox"/>	16 Bit <input type="checkbox"/>	18 Bit <input type="checkbox"/>	36 Bit <input type="checkbox"/>	

Title COMMUNICATION CABLE INTERFACE INFORMATION				Tech Tip Number DATA.COM. TT-1		
All	Processor Applicability			Author Bill Freeman	Rev 0	Cross Reference
	8	8I	8L	12	Approval W. Cummins	

Cables interfacing DEC terminals (communication interfaces) to data sets come in several varieties depending upon the terminal to be utilized. The following are cable types issued by DEC and the terminal interface that the cable may be used with:

<u>Cable</u>	<u>Interface</u>
BCØ1A	8/I, 8/L, DCØ2
BCØ1B	DCØ8F
BCØ1C	8, DCØ8B, PTØ8B, PTØ8C
BCØ1E	DCØ8B
BCØ1J	8/I, 8/L, 12, DCØ2*
BC01V	KL8E, KL8F, KL8M, DP8EA
7Ø-5717	PTØ8F, PTØ8FX, 689 MQ, 689 MA
74-6139	689AF, 689AG
7Ø-5639	DPØ1A
74-6136	689 ADF
74-7226	DCØ8H
BCØ5C	DP86A

Following is a table giving the standard signals assigned by EIA Standard RS232. Each data cable is listed giving the pins utilized on the data set connector (TYPE DB25P - The hood is Type DB51226-1). Of the several data sets available below are listed the most common along with any differences they have in relation to the EIA Standard. The data sets are also noted on the following table in relation to the signals they used.

- * Utilizes Type DBM255 Female Data set connector.

<u>Data Set</u>	<u>Differences from Standard</u>
* Bell 1Ø3 A,E, G,H	
# Bell 10JF	Pin 11 and 12 are originate mode and local mode respectively
+ Bell 2Ø2.C,D	Pin 19 remote release Pin 20 remote control Pin 21 Ready Pin 22 Ring indicator 1 Pin 23 Ring indicator 2
** Bell 2Ø1 Synchronous modem	

Data Set Pin #	EIA-RS232 Pin Assignments	CABLE TYPE													
		BC01A	BC01B	BC01C	BC01E	BC01J	BC01V	70-5717	74-6139	BC05C	70-5639**				
		M850	W853	G857	G857	M850	BERG	W023	W023	BERG	W023				
1	Protective GND	*	#	+	X	X	X	Tied to 7	X	Tied to 7	X	X	X	X	X
2	Transmitted Data	*	#	+	X	X	X	X	X	X	X	X	X	X	X
3	Receive Data	*	#	+	X	X	X	X	X	X	X	X	X	X	X
4	Request to Send	*	#	+	X					X		X	X	X	X
5	Clear to Send	*	#	+	X			X	X	X			X	X	X
6	Data Set Ready	*	#	+	X			Tied to 5	Tied to 5	X			X	X	X
7	Signal GND	*	#	+	X	X	X	X	X	X	X	X	X	X	X
8	Data Carrier Detect	*	#	+		X		Tied to 6	Tied to 6	X		X	X	X	X
9	Reserved for testing	*	#	+										X	
10	Not to be used in terminal	*	#	+										X	
11										X				X	
12	Sec. Rec. Line Sig. Detector		#			X				X				X	
13	Sec. Clr to Send													X	
14	Secondary Transmitted Data					X								X	X
15	Transmit Signal Element Timing					X				X				X	
16	Secondary Received Data													(note)	X
17	Receive Sig. Element Timing									X				(note)	X
18														X	
19	Secondary Request to Send			+										X	
20	Data Terminal Ready	*	#	+	X	X	X			X	X	X	X	X	X
21	Signal Quality Detector	*	#	+										X	
22	Ring Indicator	*	#	+		X				X		X	X	X	X
23	Data Signal Rate Selector			+										X	
24	Transmit Sig. Element Timing					X				X				X	X
25						X				X		X	X	X	

NOTE: Shielded conductor tied to ground pins on both ends.

digital	FIELD SERVICE TECHNICAL MANUAL				Option or Designator
	12 Bit <input checked="" type="checkbox"/>	16 Bit <input type="checkbox"/>	18 Bit <input type="checkbox"/>	36 Bit <input type="checkbox"/>	DATA COMMUNICATIONS TO DC02F

Title			COMMUNICATION CABLE INTERFACE INFORMATION		Tech Tip Number DATA COM-TT-1
All	Processor Applicability		Author Bill Freeman	Rev 0	Cross Reference
	8	8I	8L	12	

Data Set Pin#	8#1 Automatic Calling Unit Pin Assignment	Cable Type	
		74-6136	74-7226
		W023	W853
1	Frame Ground	X	X
2	Digit Present	X	X
3	Abondon Call & Retry	X	X
4	Call Request	X	X
5	Present Next Digit	X	X
6	Power Indication	X	X
7	Signal Ground	X	X
8			X
9	Reserved		
10	Reserved		
11			
12			
13	Data Set Status		X
14	Digit 1	X	X
15	Digit 2	X	X
16	Digit 3	X	X
17	Digit 4	X	X
18	Reserved		
19	Reserved		
20	Reserved		X
21	Reserved		
22	Data Line Occupied	X	X
23	Reserved		
24			
25	Reserved		

Title SPEED SELECTION OF M453 CLOCK						Tech Tip Number DC02-TT-1		
All	Processor Applicability					Author W. Freeman	Rev 0	Cross Reference M453-TT-1
	8	I				Approval W. Cummins	Date 07/31/72	

Title REMOVAL OF READER RUN						Tech Tip Number DC02F-TT-1		
All	Processor Applicability					Author	Rev 0	Cross Reference
	1	2				Approval H. Long	Date 8-17-72	

When clearing TTY Keyboard flag, Reader run is set causing tape to advance this is undesirable in some programming situations.

CORRECTION:

Clear Flag with IOP4 (Read Buffer) and set Reader run with IOP2.
 TT AC clear L. Sets Reader run instead of KCCL.
 TT I Strobe H on input of KCCL, instead of grd.

Wiring to be done on each in DC02, AB09, AB10, etc.

Delete: (KLCL) A09V2 A09E2
 (GND) B09D1 B09C2
 (GND) B09D1 B09T1 (if present)

Add (TT AC clear L) B09E2 A09V2
 (TT I Strobe H). B09D1 A09V1

Note: Pins B09D1, B10D1, etc. are bussed to gnd. Bus must be cut.

digital	FIELD SERVICE TECHNICAL MANUAL				Option or Designator
	12 Bit <input checked="" type="checkbox"/>	16 Bit <input type="checkbox"/>	18 Bit <input type="checkbox"/>	36 Bit <input type="checkbox"/>	DC08A

Title				680I (DC08) JUMPER CONFIGURATION		Tech Tip Number		DC08A-TT-1	
All		Processor Applicability		Author		Rev		0	
BT				Approval		W. Cummins		Date	
								07/31/72	
								Cross Reference	

The following is a list of possible jumper configurations for the M750 module in the DC08A:

OUTPUT JUMPERS

DESIRED OUTPUT CONDITION	JUMPER FOR EVEN LINE	JUMPER FOR ODD LINE
Mark = Low	E2 to U2	R2 to T2
Mark = High	F2 to U2	P2 to T2
INPUT JUMPERS		
DESIRED INPUT CONDITION	JUMPER FOR EVEN LINE	JUMPER FOR ODD LINE
Mark = Low	J1 to M2	K1 to N2
	C1 to H1	E1 to L2
Mark = Low Filtered	D2 to M2	N2 to V1
	A1 to J1	K1 to U1
	C1 to H1	E1 to L2
Mark = High	C1 to M2	E1 to N2
Mark = High Filtered	D2 to M2	N2 to V1
	A1 to C1	E1 to U1

The input and output conditions required for the DC08 options are listed below. The required conditions for the particular option can be obtained by M750 jumper installation as detailed in the table above.

OPTION	OUTPUT	INPUT
DC08B using W076D modules	Mark = Low	Mark = Low Filtered Mark = Low*
DC08B using BC01 cables	Mark = Low	Mark = Low
DC08F, FE, and FF using BC01B cables	Mark = Low	Mark = Low
689AG or 689MQ using W670 and W570 modules	Mark = High	Mark = High
DC08C using G856 or G860 modules (Polar or Positive Battery)	Mark = Low	Mark = Low
DC08C using G856 or G860 modules (Negative Battery)	Mark = High	Mark = High
DC08CS using G862 and G861 modules **	Mark = Low	Mark = Low

Title 6801 (DC08) JUMPER CONFIGURATION						Tech Tip Number DC08A-TT-1		
All	Processor Applicability					Author	Rev 0	Cross Reference
	8I					Approval W. Cummins	Date 7/31/72	

Low and High refer to polarities as seen at the input (Pin E1, C1) and Output (Pin S2, S1) of the M750 line I/O control module for each line. Low - 0 volts DC and High = +3 volts DC.

** Jumpers on G861 parallel for POSITIVE Battery
 "X" for negative battery
 G862 no change

* All input jumpers for DC08B options are factory wired as Mark = Low. If noise problems develop with DC08B/W076D (Teletype lines) the jumpers should be changed to Mark = Low Filtered.

The ultimate method by which the input jumpers can be determined is to work back from the signal LINE MUX OUT $\bar{\phi}$ through the M750 logic to the input to the module. The polarity at LINE MUX OUT $\bar{\phi}$ must be +3 volts DC when at mark condition.

Title M410-REED CLOCK						Tech Tip Number DC08A-TT-2		
All	Processor Applicability					Author Bill Freeman	Rev 0	Cross Reference M410-TT-1
	8I					Approval Bill Cummins	Date 07/31/72	

digital	FIELD SERVICE TECHNICAL MANUAL				Option or Designator
	12 Bit <input checked="" type="checkbox"/>	16 Bit <input type="checkbox"/>	18 Bit <input type="checkbox"/>	36 Bit <input type="checkbox"/>	DC08C

Title	Handling and Testing Boards with Mercury Wetted Relays	Tech Tip Number	DC08C-TT-1
All	Processor Applicability	Author	W. Cummins
		Rev	0
81		Approval	W. Cummins
		Date	07/31/72
			Cross Reference

The following modules use mercury wetted relays in communication systems:

G852 G855 G856 G860

The manufacturer of the relays state there are two (2) general causes of relay failure.

- a. High voltage transients may exceed the contact ratings, overheat the contacts and cause them to weld together.
- b. Improper handling of the module on which the relays are mounted.

To eliminate the failure "a" the following should be noted:

The output from each module may be a high DC voltage taken from the switched contact of the relay. In the DC08C, the G856 is used when the battery is less than 80 volts while the G860 is used for a battery of greater than 80 volts. The difference between the two modules is the arc suppression across the switches output contact.

The input is a 100 ohm relay coil and cannot withstand a current greater than 100 ma. With this limitation the input cannot be connected directly to the output without a series current limiting resistor.

Since the coil current cannot exceed 100ma, and the coil resistance is fixed at 100 ohms, the value of the resistor will be a function of the battery voltage used with DC08C or DC08D interface. A typical resistor value would be 2.2K ohms, 2 watts for a 60 volt battery. The coil will operate at a minimum of about 8 ma, however optimum current range is 35-55ma.

A tester is available which includes a power supply which may be utilized if the customer's DC power (battery) is not available to supply voltage to the G856's or G860's. If the tester supply is used, it will probably be necessary to adjust the receive relay bias setting both when the tester is connected into the DC08C and when the system is returned to normal operation using customer battery (see Installation Manual, Section 9). It is therefore advisable to use the customer's battery whenever it is available.

Title Handling and Testing Boards with Mercury Wetted Relays (Continued)						Tech Tip Number DC08C-TT-1		
All Processor Applicability						Author W. Cummins Rev 0		Cross Reference
8I						Approval W. Cummins Date 07/31/72		

A simplified by typical representation of the input/output lines for test or installation would be:

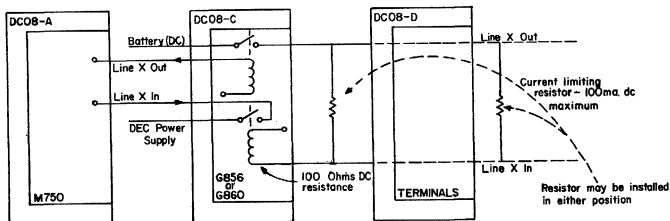

WARNING: Damaging overheating will result if the DC08-C tester is connected into a circuit and power is applied for a period exceeding six hours.

WARNING: Damaging overheating will result if the DC08-C tester is connected into a circuit and power is applied for a period exceeding six (6) hours.

According to the manufacturer, "b" (preceding page) failures are essentially a result of operating the relay before the mercury has a chance to settle. When the board is in other than the normal operating position the contacts are immersed in mercury. When the board is inserted into the system and the relay is actuated, it is possible that the contacts, bridged by mercury, will allow a high current to flow, causing them to overheat and weld together. To help eliminate these "handling" failures, the following procedures are recommended by the manufacturer:

1. Let the board remain stationary, plugged into the system, for a minimum of twenty-four (24) hours, or
2. run the transmit relay without applying power to the contacts for several minutes or
3. after inserting the boards, but before operating them, vibrate them gently by tapping them in the direction of the arrows with a pencil or module vibrator stick, etc., or

digital	FIELD SERVICE TECHNICAL MANUAL				Option or Designator
	12 Bit <input checked="" type="checkbox"/>	16 Bit <input type="checkbox"/>	18 Bit <input type="checkbox"/>	36 Bit <input type="checkbox"/>	DC08C to DC14

Title	HANDLING OF BOARDS USING MERCURY WETTED RELAYS (Continued)			Tech Tip Number	DC08C-TT-1
All	Processor Applicability		Author W. Cummins	Rev g	Cross Reference
8I			Approval W. Cummins	Date 07/31/72	

4. vibrate as in part "3", but prior to insertion. After tapping them, handle them very carefully to eliminate splashing excess mercury back onto the contacts.

Part "4" is recommended as out standard Field Service procedure.

It is understood that many times these G series modules must be inserted or removed with power on. When this is done the module must remain in an orientation indicated by the arrows on the relays. IN NO CASE should the module be subjected to vibration since mercury splashing around inside the relay may cause direct shorts of high voltage DC to ground, ruining the module.

In some DC08C systems using G856 and G860 modules the relays are isolated from the battery by a separate fuse for each line in an 893 fuse panel. With such a panel, the four fuses associated with the line in question (remember, 2 lines to a module) should be removed prior to insertion or removal of the module.

Title DC14 OPTION LIST						Tech Tip Number DC14-TT-1		
All	Processor Applicability					Author Larry Goelz	Rev 0	Cross Reference
						Approval George Chaisson	Date 03/28/73	
14								

The following options are used in the DC14

<u>Option</u>	<u>Description</u>
DC14-A	PDP14 Serial Interface Modules - These modules plug into the PDP14, one per PDP14 that is connected to a PDP8E or PDP11. (M746-2, M748, M749, M589, M921)
DC14-LA	Same as DC14-A but for a PDP14-L. Modules are M748, M749, M589.
DC14-B	Master Control - plugs into the PDP8, one master control will handle up to is 15 channels of serial line. (M8332, 1 Channel Connector Panel.)
DC14-C	Channel Logic, plugs into the PDP8 or DD14-A, one channel logic per every PDP14 or PDP14-L connected to a PDP8 or PDP11. (M8333, 1 H851 Connector, 1 6-pin Mate-N-Lock)
DC14-D	Master Control - plugs into DD14-A, one master control will handle up to 15 channels of serial line. (M8334, 1 Channel Connector Panel.)
DD14-A	Serial Interface System Unit, provides slots to accommodate DC14D and DC14C. Used on PDP11.

Title DOCUMENTATION LIST						Tech Tip Number DC14-TT-2		
All	Processor Applicability					Author Larry Goelz	Rev 0	Cross Reference
						Approval G. Chaisson	Date 03/28/73	
14								

The following documentation, describing the technical characteristics of the DC14, may be ordered through the Field Service Information Center, Maynard. This service is available to DEC Field Service personnel only.

DESIGNATION	DESCRIPTION
B-DD-DC14- g	DC14 Print Set Engineering Note #5 (PDP8) #14 (PDP11)
MAINDEC-14-DBQAA-A	Diagnostic Tape & Writer

PAGE 112	PAGE REVISION 0	PUBLICATION DATE March 1973
----------	-----------------	-----------------------------

digital	FIELD SERVICE TECHNICAL MANUAL				Option or Designator
	12 Bit <input checked="" type="checkbox"/>	16 Bit <input type="checkbox"/>	18 Bit <input type="checkbox"/>	36 Bit <input type="checkbox"/>	DC14

Title DC14 ECO/FCO List					Tech Tip Number DC14-TT-3		
All	Processor Applicability				Author Larry Goelz	Rev 0	Cross Reference
	14				Approval G. Chaisson	Date 03/28/73	

The following ECO/FCO listing is provided to insure that the ECO status of this equipment may be swiftly and accurately determined on site. Note that the "Indication of Accomplishment" column normally lists only a psrt of the total ECO and FCO documents must be consulted if further information is needed.

Equipment	ECO Change	Priority	Units/Affected	Purpose	Ind. of Accomp.
M748 (DC14A)	M748-00001	Mandatory	All Units shipped prior to 3/15/72	To Allow MAX Baud Rate to operate w/o error	Module is Rev. D

Title DC14 IMPLEMENTATION					Tech Tip Number DC14-TT-4		
All	Processor Applicability				Author Larry Goelz	Rev 0	Cross Reference
	14				Approval G. Chaisson	Date 03/28/73	

In order to install DC14, Serial Line Interface, in the field the following requirements must be met.

1. Have PDP14
2. Have PDP8 or PDP11
3. Have DC14-A, DC14-C, DC14-B (PDP8) or DC14-D (PDP11)
4. Must have DC14-D cable for each PDP14 to run between processor and PDP14.
5. PDP14 must have ECO PDP14-00043 installed
6. M742 module must be Rev. F or higher with ECO M742-05 accomplished.
7. M741 module must be Rev. C or higher or have ECO M741-03 accomplished

Title BAUD RATE FOR DC14					Tech Tip Number DC14-TT-5		
All	Processor Applicability				Author Larry Goelz	Rev 0	Cross Reference
	14				Approval G. Chaisson	Date 7/11/73	

Due to an engineering oversite all baud rates other than 211.2KHz cannot be used on the DC14 option. This applies to all units shipped to date and all future units.

-- NOTES --

digital	FIELD SERVICE TECHNICAL MANUAL				Option or Designator
	12 Bit <input checked="" type="checkbox"/>	16 Bit <input type="checkbox"/>	18 Bit <input type="checkbox"/>	36 Bit <input type="checkbox"/>	DEC/X8

Title DEC/X8 PATCH TO RANDOMIZE ROTATION				Tech Tip Number DEC/X8-TT-1	
All 8's	Processor Applicability		Author Herbener/Shelley	Rev 0	Cross Reference SFTWRE-TT-9
			Approval F. Purcell	Date 01/24/73	

Title SYNOPSIS OF INFORMATION ON DEC-X8 SOFTWARE MODULES				Tech Tip Number DEC/X8-TT-2	
All	Processor Applicability		Author Don Herbener	Rev 0	Cross Reference
			Approval Frank Purcell	Date 02/14/73	

This Tech Tip is a synopsis of all building and running information needed for the DEC-X8 Systems Exerciser Software Modules. Its purpose is to provide in concise form all information needed to run a software module. Each module will contain most of the following subdivisions:

- | | |
|---------------------------|------------------------------|
| A. Module Description | G. Initializing |
| B. Requirements | H. Device Setup |
| C. Restrictions | I. Running |
| D. Operating Information | J. Error Information |
| E. Special Considerations | K. Error Symbol Definitions. |
| F. Building | |

Below is a list of current modules listed in this Tech Tip.

- | | |
|------------|------------|
| 1. DC02 | 14. RF08DS |
| 2. DF32DS | 15. RK8DS |
| 3. EAEALL | 16. RK8EDS |
| 4. EAEDP | 17. TA8ECS |
| 5. FPP-12 | 18. TC01DT |
| 6. HSRHSP | 19. TC12LT |
| 7. MR108A | 20. TC58MT |
| 8. MULTTY | 21. TD8EDT |
| 9. NOTFUN | 22. TIMERA |
| 10. OPRATE | 23. TM8EMT |
| 11. PLOTER | 24. VCAD8E |
| 12. PRNTER | 25. VT8E |
| 13. RANMRI | |

Title SYNOPSIS OF INFO ON DEC/X8 SOFTWARE MODULES (Cont'd)						Tech Tip Number	DEC/X8-TT-2			
All	Processor Applicability					Author	Don Herbener	Rev	g	Cross Reference
						Approval	Frank Purcell	Date	02/14/73	

THE DEC/X8 SOFTWARE MODULE INDEX CONTAINS A LIST OF CURRENT DEC/X8 SOFTWARE MODULES WITH INFORMATION PERTAINING TO THE FOLLOWING:

1. MODULE NAME
2. PRODUCT CODE INDICATING THE LATEST REVISION ("MAINDEC-X8" ASSUMED).
3. DEVICE(S) TO WHICH THE MODULE APPLIES. A DEVICE(S) WHICH APPEARS ON THE SAME LINE AS AN ASTERISK (*) IS BETTER TESTED BY ANOTHER MODULE WITHIN THE INDEX.
4. INTERRUPT DRIVEN OR BACKGROUND MODULE
5. NUMBER OF MEMORY PAGES REQUIRED BY THE MODULE
6. RECOMMENDED RELATIVE DEC/X8 SOFTWARE PRIORITY LEVEL. THE RECOMMENDED LEVEL IS INDICATED BY THE "PRIORITY CODE" "A"

THROUGH "Z", WHERE "A" REPRESENTS THE HIGHEST PRIORITY GROUPING (STARTING AT LEVEL 00) SEQUENTIALLY TO "Z" REPRESENTING THE LOWEST PRIORITY GROUPING (GENERALLY BACKGROUND). ANY MODULES BELONGING TO THE SAME PRIORITY GROUPING MAY BE PLACED IN ANY PRIORITY ORDER WITHIN THAT GROUP.

7. ALLOWABLE OMISSIONS FROM INCLUSION BECAUSE OF MEMORY LIMITATIONS. IF OMISSIONS ARE NECESSARY, IT IS RECOMMENDED THAT THOSE ITEMS WITH "OMISSION CODE" "A" BE OMITTED FIRST, THEN "B", ETC..
8. RECOMMENDED DEVIATIONS FROM AN EIGHT HOUR RUNTIME PERIOD. THE RECOMMENDED RUNTIME RESTRICTIONS NOTED IN THE INDEX ARE BASED UPON EITHER DEVICE WEAR OR OPERATOR COVERAGE CONSIDERATIONS. REMARKS APPLY ONLY TO THOSE DEVICES ON THE SAME LINE.

THIS INDEX WILL BE UPDATED AS PART OF EVERY FUTURE DEC/X8 SOFTWARE RELEASE.

Title SYNOPSIS OF INFO ON DEC/X8 SOFTWARE MODULES (Cont)										Tech Tip DEC/X8-77-2			
Processor Applicability										Author Don Herdener		Rev 0	
All										Approval Frank Purcell		Date 02/14/73	
												Cross Reference	

MODULE NAME	MAINDEC -X8-	APPLICABLE DEVICES	INT BACK	MEMORY PAGES	PRIOR CODE	OMISS CODE	RECOMMENDED RUNTIME RESTRICTIONS
RK8EDS	DHRKA-A	RK8-E DECDISK	INT	4	E	Z	NONE
TABECS	DHTAA-A	TA8-E DECCASSETTE	INT	4	B	Z	NONE
TM8EMT	DHTMA-A	TM8-E DECMAGTAPE	INT	4	F	Z	NONE
VT8E	DHVTA-A	VT8-E DECDISPLAY	INT	4	D	Z	NONE
VCAD8E	DHVCA-A	VC8-E DECDISPLAY AD8-E/AM8-E ADC	BACK	2	Z	C	NONE
TDBEDT	DHTDA-A	TD8-E DECTAPE	BACK	4	Z	Y	NONE
PLOT8R	DIXYA-A	XY8-E,XY12,VP8I [8L]	INT	4	G	C	1 HOUR DURING 8 HOUR RUN WITH PLOTTER IN REMOTE

digital	FIELD SERVICE TECHNICAL MANUAL				Option or Designator
	12 Bit <input checked="" type="checkbox"/>	16 Bit <input type="checkbox"/>	18 Bit <input type="checkbox"/>	36 Bit <input type="checkbox"/>	DEC/X8

Title SYNOPSIS OF INFO ON DEC/X8 SOFTWARE MODULES (Cont)				Tech Tip Number	DEC/X8-TT-2
All	Processor Applicability		Author Don Herbener	Rev 0	Cross Reference
			Approval Frank Purcell	Date 02/14/73	

1. DC02 MODULE DESCRIPTION

"DC02" IS A DEC/X8 SOFTWARE MODULE WHICH EXERCISES ANY DC02 SERIES TELETYPE CONTROL. THE ACTUAL OUTPUT DEVICE MAY BE A TTY OR A CRT ASCII DISPLAY (VT05-VT06). EXERCISING IS ACCOMPLISHED VIA OUTPUTTING ONTO THE TTY PRINTER THE FOLLOWING MESSAGE:

"DEC/X8 EXERCISING DC02 LINE X"
 "X" EQUALS THE LINE NUMBER IN THE DC02 CONTROL.

2. REQUIREMENTS

1. PROCESSORS: PDP-8, 8/I, 8/L, 8/E, 8/M AND PDP-12
2. OPTIONS: ANY HARDCOPY OR CRT ASCII DEVICE WHICH IS TTY COMPATIBLE.
3. SPECIAL: NONE

3. RESTRICTIONS

NONE

4. OPERATING INFORMATION

4.1 SPECIAL CONSIDERATIONS

THIS MODULE MUST BE INITIALIZED BEFORE RUNNING.

4.2 BUILDING

1. JOB TYPE: INTERRUPT DRIVEN

2. PRIORITY: NON-CRITICAL; HOWEVER INTERRUPTS MAY OCCUR AT A HIGH FREQUENCY.

3. JOB SLOT: ANY EXISTENT JOB SLOT; 2 PAGES REQUIRED.

4. STANDARD DEVICE CODES:
 0110 STANDARD FOR RECEIVER
 0120 STANDARD FOR TRANSMITTER.

4.3 INITIALIZING

AFTER "DC02" IS PRINTED TYPE THE FOLLOWING:

"0" IF A DC02A, DC02D, DC02E OR
 1 DC02F CONTROL.
 "1"- "3" INDICATING THE NUMBER OF
 ADDITIONAL DC02F CONTROLLERS.

4.4 DEVICE SETUP

THE OUTPUT DEVICES MUST BE POWERED UP AND ON LINE. THE INPUT DEVICES MUST BE DISABLED FROM CAUSING AN INTERRUPT.

4.5 RUNNING

1. CNTR: UPDATED UPON EACH DC02 INTERRUPT
2. SR10: NO EFFECT
3. SR11: NO EFFECT

5. ERROR INFORMATION

THE ONLY DETECTABLE ERROR IN THIS MODULE IS THE SETTING OF A KEYBOARD RECEIVER FLAG. WHEN THIS FLAG IS SENSED A "STAT ERR" IS REPORTED AND THE VALUE OF "CODE" CONTAINS THE DC02 LINE THE KEYBOARD FLAG OCCURRED ON.

Title SYNOPSIS OF INFO ON DEC/X8 SOFTWARE MODULES (Cont)						Tech Tip Number DEC/X8-TT-2	
All		Processor Applicability		Author Don Herbener		Rev 0	
				Approval Frank Purcell		Date 02/14/73	
Cross Reference							

1. DF32DS MODULE DESCRIPTION

"DF32DS" IS A DEC/X8 SOFTWARE MODULE WHICH EXERCISES A DF32/DF32-D DECDISK SYSTEM WITH UP TO FOUR DISKS. THE MAIN CHARACTERISTICS OF THIS MODULE ARE:

1. READ/WRITE TRANSFERS VARY RANDOMLY FROM 1 TO 1000(8) WORDS.
2. DISK ADDRESSES ARE SELECTED RANDOMLY BETWEEN ADDRESS 00000 OF THE LOWEST NUMBERED DISK SPECIFIED AND ADDRESS 77777 OF THE HIGHEST DISK SPECIFIED.
3. TRANSFERS WILL OCCUR ACROSS DISK BOUNDARIES AND IN THE CASE OF 4 DISK SYSTEMS WILL WRAP AROUND TO DISK 0.
4. EACH PASS OF THE EXERCISER LOOP EXECUTES WRITE/READ/DATA CHECK STARTING AT A RANDOMLY SELECTED DISK ADDRESS.
5. THREE READS ARE DONE IN THE CASE OF A PARITY ERROR.

2. REQUIREMENTS

1. PROCESSORS: PDP-8, 8/I, 8/L, 8/E, 8/M AND PDP-12.
2. OPTIONS: DF32 OR DF32-D DECDISK CONTROL WITH UP TO 4 DISKS.
3. SPECIAL: NONE

3. RESTRICTIONS

THERE MUST BE AN EXISTENT DISK 0.

4. OPERATING INFORMATION

CODE	DEFINITION	RESPONSE	LIMITS	PRESET
A	LOWEST DISK	N	0-3	0
B	HIGHEST DISK	N	0-3	0
C	TYPE OF DATA	0 FOR RANDOM 1 NNNN FOR CONSTANT	ANY DATA WORD	RANDOM
D	DISK ADDRESS AT WHICH TRANSFER BEGINS	0 FOR RANDOM 1 NN00 NNNN (EDA) (DMA)	LEGAL ADDRESS	RANDOM
E	TRANSFER LENGTH	0 FOR RANDOM 1 NNNN	0001-1000	RANDOM
F	BUFFER TO USE	0 FOR RANDOM 1 NNNN	LEGAL DESIGNATOR	RANDOM

4.1 SPECIAL CONSIDERATIONS

THIS MODULE REQUIRES EXTERNAL BUFFERS.

4.2 BUILDING

1. JOB TYPE: INTERRUPT DRIVEN
2. PRIORITY: NON-CRITICAL BUT SHOULD BE PLACED HIGH ON THE LIST TO PROVIDE GREATER INTERACTION.
3. JOB SLOTS: JF1 OR JF2 ONLY; 4 PAGES REQUIRED.
4. STANDARD DEVICE CODES: 0600, 0610, 0620
5. STANDARD WORD COUNT: 7750
6. STANDARD CURRENT ADDRESS: 7751

4.3 INITIALIZING

AFTER THE INDICATED CODE LETTER IS PRINTED RESPOND BY TYPING THE PARAMETER IN THE MANNER SHOWN BELOW.

IN ADDITION THE FOLLOWING MODULE LOCATIONS MAY BE CHANGED AS INDICATED TO ACHIEVE THE DESIRED RESULTS.

1. "REPORT" (0424) MAY BE CHANGED FROM 0007 TO 000X WHERE ANY CLEAR BITS ARE NOT REPORTED AS ERRORS. BIT ASSIGNMENT IS THE SAME AS FOR THE DF32/DF32-D STATUS REGISTER.
2. "PARITY" (0721) MAY BE CHANGED FROM 0006 TO 0007 TO INHIBIT DATA CHECKING AFTER PARITY ERRORS.

	FIELD SERVICE TECHNICAL MANUAL				Option or Designator
	12 Bit <input checked="" type="checkbox"/>	16 Bit <input type="checkbox"/>	18 Bit <input type="checkbox"/>	36 Bit <input type="checkbox"/>	DEC/X8

Title				SYNOPSIS OF INFO ON DEC/X8 SOFTWARE MODULES (Cont)		Tech Tip Number		DEC/X8-TT-2	
All		Processor Applicability		Author Don Herbener		Rev 0		Cross Reference	
				Approval Frank Purcell		Date 02/14/73			

4.4 DEVICE SETUP

WRITE ENABLE ALL DISKS TO BE EXERCISED.

4.5 RUNNING

1. CNTR: UPDATED AFTER A WRITE/READ/DATA CHECK OPERATION IS COMPLETED.
2. SR10: WHEN SET TO A 1, THE BUFFER CURRENTLY ASSIGNED IS RETAINED.
3. SR11: WHEN SET TO A 1, THE CURRENT DISK STARTING ADDRESS IS RETAINED.

5. ERROR INFORMATION

ALL STATUS REGISTER INDICATED ERRORS ARE REPORTED AS STATUS ERRORS. DATA ERRORS IN THE DATA ERROR FORMAT.

5.1 ERROR SYMBOL DEFINITIONS

CODE:

0002 READ
0004 WRITE

0012 FALSE DATA ERROR (BAD SOFTWARE CHECKSUM BUT DATA LOOKED GOOD ON A WORD BY WORD CHECK). THIS TYPE OF ERROR MAY BE REPORTED AFTER A PARITY ERROR AND INDICATES THE FOLLOWING: 1) THE PARITY ERROR STOPPED THE TRANSFER PRIOR TO COMPLETION AND THEREBY CAUSED A SOFTWARE SUMCHECK ERROR; 2) THE DATA TRANSFERRED WAS GOOD.

003X TRANSFER INCOMPLETE (WORD COUNT NON-ZERO BUT NO STATUS REGISTER ERROR BIT IS SET)

0042 THIS ERROR MAY FOLLOW CODE 0032 REPORTS AND INDICATES THAT ALTHOUGH A TRANSFER WAS INCOMPLETE THE DATA THAT WAS TRANSFERRED WAS GOOD.

01XX INDICATES NXD/WLS BIT IS NXD

02XX INDICATES NXD/WLS BIT IS WLS

SA: FINAL CONTENTS OF THE STATUS REGISTER (ALL 12 BITS FROM D1EF)

SB: CURRENT BUFFER DESIGNATOR

SC: INITIAL WORD COUNT

SD: FINAL WORD COUNT

SE: INITIAL CURRENT ADDRESS

SF: FINAL CURRENT ADDRESS

SG: INITIAL EDA (INCLUDING FIELD BITS)

SH: INITIAL DMA

SI: FINAL EDA (ALL 12 BITS FROM D1EF)

SJ: FINAL DMA

DA: BUFFER ADDRESS

DB: GOOD DATA WORD

DC: BAD DATA WORD

Title SYNOPSIS OF INFO ON DEC/X8 SOFTWARE MODULES (Cont)						Tech Tip Number DEC/X8-TT-2
All	Processor Applicability				Author Don Herbener	Rev 0
					Approval Frank Purcell	Date 02/14/73
						Cross Reference

1. EAEALL MODULE DESCRIPTION

"EAEALL" IS A DEC/X8 SOFTWARE MODULE WHICH EXERCISES THE MUY, DVI, SHL, ASR, LSR AND NMI INSTRUCTIONS IN ALL FAMILY-OF-8 EAES. IN THE KE8E EAE BOTH MODES "A" AND "B" ARE UTILIZED. REFER TO PARAGRAPH 4.3 FOR INITIALIZING INFORMATION.

"EAEALL" IS DIVIDED INTO FIVE TEST SECTIONS, TEST X000 THROUGH X004. TEST X000 EXERCISES MUY AND DVI BY SOLVING THE PROBLEM:

$$A^*B/B^*B/A^*A/B^*B/A=B$$

TESTS X001 THROUGH X003 EXERCISE SHL, LSR, AND ASR RESPECTIVELY. THE NUMBER OF SHIFTS RANGE FROM 1 TO 40 (37 IN A KE8E EAE MODE "B"). THE MAXIMUM NUMBER OF SHIFTS ALLOWED MAY BE CHANGED BY THE USER.

TEST X004 EXERCISES THE NMI INSTRUCTION. THE RESULT OF THE NORMALIZE IS CHECKED BY THE USE OF THE ASR INSTRUCTION.

SINCE TESTS X001 THROUGH X004 MAY CAUSE "DATA REQUEST LATE" OR "DATA RATE" ERRORS ON SOME HIGH SPEED DIRECT MEMORY ACCESS (DATA BREAK) DEVICES, THE USER HAS THE ABILITY TO BYPASS THESE TESTS AND RUN JUST TEST X000. HOWEVER, TEST X000 MAY ALSO CAUSE SIMILAR ERRORS TO OCCUR.

2. REQUIREMENTS

- A. PROCESSORS: PDP-8, 8/I, 8/E, 8/M OR PDP-12.
 B. OPTIONS: EXTENDED ARITHMETIC ELEMENT (EAE)
 C. SPECIAL: NONE

3. RESTRICTIONS

NONE

4. OPERATING INFORMATION

4.1 SPECIAL CONSIDERATIONS

THIS MODULE REQUIRES A NON-VOLATILE STEP COUNTER AND GT FLAG. SR5 SHOULD BE SET TO 0 WHEN THIS MODULE IS RUNNING SINCE THE MQ IS UTILIZED.

"DATA REQUEST LATE" OR "DATA RATE" ERRORS MAY OCCUR IF THIS MODULE IS RUN WHILE EXERCISING A HIGH SPEED DIRECT MEMORY ACCESS (DATA BREAK) DEVICE.

4.2 BUILDING

- A. JOB TYPE: BACKGROUND
 B. PRIORITY: MUST HAVE LOWER PRIORITY THAN ALL INTERRUPT JOBS; OTHERWISE UNIMPORTANT.
 C. JOB SLOTS: JOB SLOTS JF1 AND JF2 ONLY; 4 PAGES REQUIRED.

4.3 INITIALIZING

AFTER "EAEALL" IS PRINTED THE USER SHOULD TYPE THE NUMERICAL CODE NN INDICATED TO ACHIEVE THE DESIRED RESULTS.

CODE	RESULTS
00	SPECIFIES A PDP-8, 8/I OR PDP-12 EAE, OR "A" MODE ONLY IN A KE8E EAE. SHIFT AND NORMALIZE TESTS ARE BYPASSED.
01	SAME AS "00" EXCEPT ALL TESTS ARE RUN.
10	"B" MODE ONLY IN A KE8E EAE. SHIFT AND NORMALIZE TESTS ARE BYPASSED.
11	SAME AS "10" EXCEPT ALL TESTS ARE RUN.
20	BOTH "A" AND "B" MODES ARE UTILIZED IN A KE8E EAE. SHIFT AND NORMALIZE TESTS ARE BYPASSED.
21	SAME AS "20" EXCEPT ALL TESTS ARE RUN.

NOTE

THE PRESET CONDITION IS "21".

IN ADDITION, THE MAXIMUM NUMBER OF SHIFTS CAN BE CONTROLLED BY SETTING LOCATION "KXXXX" (0364) TO THE MAXIMUM NUMBER OF SHIFTS VIA THE \uparrow O COMMAND. WHEN IN KE8E EAE "A" MODE OR IF A PDP-8, 8/I OR PDP-12 EAE, THE MAXIMUM NUMBER OF SHIFTS WILL BE THE SAME AS THAT SPECIFIED IN KXXXX. HOWEVER, IN KE8E "B" MODE THE MAXIMUM NUMBER OF SHIFTS WILL BE ONE LESS THAN SPECIFIED IN KXXXX. THIS LOCATION IS PRESET TO 0040.

4.4 DEVICE SETUP

NONE

4.5 RUNNING

- A. CNTR: UPDATED AFTER ONE PASS THROUGH ALL TESTS.
 B. SR10: NO EFFECT.
 C. SR11: NO EFFECT.

5. ERROR INFORMATION

ALL ERRORS RESULT IN A "STAT ERR" REPORT. THE MEANINGS OF THE VARIOUS STATUS WORDS, SA, SB, ETC. VARY ACCORDING TO THE CONTENTS OF "CODE".

DIGITAL EQUIPMENT CORPORATION

digital	FIELD SERVICE TECHNICAL MANUAL				Option or Designator
	12 Bit <input checked="" type="checkbox"/>	16 Bit <input type="checkbox"/>	18 Bit <input type="checkbox"/>	36 Bit <input type="checkbox"/>	DEC/X8

Title SYNOPSIS OF INFO ON DEC/X8 SOFTWARE MODULE (Cont):				Tech Tip Number DEC/X8-TT-2	
All Processor Applicability		Author Don Herbener	Rev 0	Cross Reference	
		Approval Frank Purcell Date 02/14/73			

5.1 "CODE" DEFINITIONS

BIT 0 OF THE "CODE" WORD INDICATES THE EAE MODE WHILE BITS 9-11 INDICATE THE FAILING TEST (0-4).

CODE WORD 000X INDICATES A FAILURE IN TEST X WITH THE EAE IN MODE "A" OR IN A PDP-8, 8/I OR PDP-12.

CODE WORD 400X INDICATES A FAILURE IN TEST X WITH THE EAE IN MODE "B" (KEB-E EAE ONLY).

5.2 STATUS WORD DEFINITIONS

A. IF CODE=X000 (MUY, DVI ERROR), THEN:

SA: OPERAND A
 SB: OPERAND B
 SC: FINAL AC (REMAINDER AFTER FINAL DVI)
 SD: FINAL MQ (QUOTIENT)
 SE: FINAL LINK (BIT 0), GT FLAG (BIT 1) AND STEP COUNTER (BITS 7-11)
 SF: FINAL AC SHOULD BE (SIMULATED)
 SG: FINAL MQ SHOULD BE (SIMULATED)
 SH: FINAL LINK, GT FLAG AND STEP COUNTER SHOULD BE (SIMULATED)

B. IF CODE=X001 (SHL) ERROR, X002 (LSR ERROR), OR X003 (ASR ERROR), THEN:

SA: STARTING AC
 SB: STARTING MQ
 SC: FINAL AC
 SD: FINAL MQ
 SE: FINAL LINK (BIT 0), GT FLAG (BIT 1) AND STEP COUNTER (BITS 7-11).
 SF: FINAL AC SHOULD BE (SIMULATED)
 SG: FINAL MQ SHOULD BE (SIMULATED)
 SH: FINAL LINK, GT FLAG AND STEP COUNTER SHOULD BE (SIMULATED)
 SI: NUMBER OF SHIFTS IN BITS 7-11

NOTE
 THE ACTUAL NUMBER OF SHIFTS IN A PDP-8, 8/I OR PDP-12 OR IN "A" MODE IS ONE GREATER THAN INDICATED.

C. IF CODE=X004 (NMI ERROR), THEN:

SA: STARTING AC
 SB: STARTING MQ
 SC: CONTENTS OF AC AFTER NMI
 SD: CONTENTS OF MQ AFTER NMI
 SE: CONTENTS OF LINK (BIT 0), GT FLAG (BIT 1) AND STEP COUNTER (BITS 7-11) AFTER NMI.
 SF: CONTENTS OF AC AFTER ASR CHECK (MAY BE SIMULATED)
 SG: CONTENTS OF MQ AFTER ASR CHECK (MAY BE SIMULATED)

Title SYNOPSIS OF INFO ON DEC/X8 SOFTWARE MODULES (Cont						Tech Tip Number DEC/X8-TT-2				
All	Processor Applicability					Author Don Herbener		Rev 0		Cross Reference
						Approval Frank Purcell		Date 02/14/73		

1. EAEDP MODULE DESCRIPTION

"EAEDP" IS A DEC/X8 SOFTWARE MODULE WHICH EXERCISES THE DPSZ, DCM, DPIC, DAD, DST, and SAM INSTRUCTIONS IN THE KE8-E EAE. ALL OPERATIONS ARE IN MODE "B".

"EAEDP" IS DIVIDED INTO FOUR TEST SECTIONS, TEST 4000 THROUGH 4003. TEST 4000 VERIFIES THAT DPSZ SKIPS WITH AC, MQ=0.

TEST 4001 VERIFIES THAT DPSZ DOES NOT SKIP WHEN AC, MQ ARE NON-ZERO.

TEST 4002 EXERCISES THE DAD, DST, DPIC, DCM AND DPSZ INSTRUCTIONS BY SOLVING THE FOLLOWING PROBLEM:

-A * A + 1 - 1 = 0

REFER TO ADDRESS "PROB" (0250) FOR THE INSTRUCTION SEQUENCE USED.

TEST 4003 EXERCISES THE SAM INSTRUCTION. REFER TO ADDRESS "SAMTST" (0300) FOR DETAILS.

2. REQUIREMENTS

A. PROCESSORS: PDP-8/E OR PDP-8/M

B. OPTIONS: KE8-E EAE

C. SPECIAL: NONE

3. RESTRICTIONS

NONE

4. OPERATING INFORMATION

4.1 SPECIAL CONSIDERATIONS

THIS MODULE REQUIRES A NON-VOLATILE GT FLAG. SRS SHOULD BE SET TO 0 WHEN THIS MODULE IS RUNNING SINCE THE MQ IS UTILIZED.

4.2 BUILDING

A. JOB TYPE: BACKGROUND

B. PRIORITY: MUST HAVE LOWER PRIORITY THAN ALL INTERRUPT JOBS; OTHERWISE UNIMPORTANT

C. JOB SLOTS: ANY EXISTENT JOB SLOT; 2 PAGES REQUIRED.

4.3 INITIALIZING

NONE REQUIRED. "JFX" RESULTS IN "EAEDP" BEING PRINTED AND A RETURN TO MONITOR.

4.4 DEVICE SETUP

NONE

4.5 RUNNING

A. CNTR: UPDATED AFTER ONE PASS THROUGH ALL TESTS.

B. SR10: NO EFFECT

C. SR11: NO EFFECT

5. ERROR INFORMATION

ALL ERRORS RESULT IN A "STAT ERR" REPORT. THE MEANINGS OF THE VARIOUS STATUS WORDS, SA, SB, ETC, VARY ACCORDING TO THE CONTENTS OF "CODE".

5.1 "CODE" DEFINITIONS

"CODE" INDICATES THE FAILING TEST: 4000 THROUGH 4003.

5.2 STATUS WORD DEFINITIONS

1. IF CODE=4000 (DPSZ SKIP ON ZERO ERROR) OR 4001 (DPSZ NO SKIP ON NON-ZERO ERROR), THEN:

SA: STARTING MQ BEFORE DPSZ

SB: STARTING AC BEFORE DPSZ

SC: MQ AFTER DPSZ (SHOULD BE THE SAME AS SA)

SD: AC AFTER DPSZ (SHOULD BE THE SAME AS SB)

2. IF CODE=4002 (DAD, DST, DPIC, DCM, OR DPSZ ERROR), THEN:

SA: LEAST SIGNIFICANT 12 BITS OF OPERAND

A.

SB: MOST SIGNIFICANT 12 BITS OF OPERAND

A.

SC: FINAL MQ (SHOULD BE 0000)

SD: FINAL AC (SHOULD BE 0000)

SE: FINAL LINK/GT WITH LINK IN BIT 0 (LINK SHOULD BE 1).

3. IF CODE=4003 (SAM ERROR), THEN:

SA: STARTING MQ

SB: STARTING AC

SC: FINAL MQ

SD: FINAL AC

SE: FINAL LINK AND GT FLAG (BIT 0=LINK, BIT 1=GT)

SF: FINAL MQ SHOULD BE (SIMULATED)

SG: FINAL AC SHOULD BE (SIMULATED)

SH: FINAL LINK AND GT FLAG SHOULD BE (SIMULATED)

digital	FIELD SERVICE TECHNICAL MANUAL				Option or Designator
	12 Bit <input checked="" type="checkbox"/>	16 Bit <input type="checkbox"/>	18 Bit <input type="checkbox"/>	36 Bit <input type="checkbox"/>	DEC/X8

Title					STNOPSIS OF INFO ON DEC/X8 SOFTWARE MODULE (Cont)		Tech Tip Number	DEC/X8-TT-2
All	Processor Applicability				Author	Don Herbener	Rev	0
					Approval	Frank Purcell	Date	02/14/73
								Cross Reference

1. FPP-12 MODULE DESCRIPTION

"FPP12" IS A DEC/X8 SOFTWARE MODULE WHICH EXERCISES THE FLOATING POINT PROCESSOR OPTION. THE FPP12 IS A SUBPROCESSOR WITH SINGLE CYCLE DATA BREAK DIRECT MEMORY ACCESS.

THIS MODULE OPERATES IN THE FOLLOWING WAY:
 ASSIGN A RANDOM BUFFER THEN MODIFY THE FPP12 INSTRUCTION SET AS TO THE MEMORY FIELD AND ADDRESS OF THE BUFFER, THEN LOAD THE "APT" TABLE INTO MEMORY AND LOAD THE FPP BUFFER FIELD AND STARTING ADDRESS POINTER REGISTERS AND START THE FPP12. WHEN AN INTERRUPT OCCURS (NORMALLY AFTER FIVE SECONDS) CHECK THE FPP ANSWER, INCREMENT THE MODULE COUNTER AND THEN RELEASE THE BUFFER JUST TESTED. THEN ASSIGN A NEW BUFFER AND REPEAT THIS CYCLE. THIS RESULTS IN TESTING THE FPP12 CODE IN ALL EXISTING MEMORY FIELDS.

2. REQUIREMENTS

1. PROCESSORS: PDP-8, 8/I, 8/L, 8/E, 8/M AND PDP-12
2. OPTIONS: FPP12
3. SPECIAL: NONE

3. RESTRICTIONS

NONE

4. OPERATING INFORMATION

4.1 SPECIAL CONSIDERATIONS

THIS MODULE REQUIRES EXTERNAL BUFFERS.

4.2 BUILDING

1. JOB TYPE: INTERRUPT DRIVEN
2. PRIORITY: NON-CRITICAL
3. JOB SLOT: JF1 OR JF2 ONLY, 4 PAGES REQUIRED.
4. STANDARD DEVICE CODE: 0550

4.3 INITIALIZING

AFTER "FPP12" IS PRINTED TYPE THE FOLLOWING PARAMETER:

FOR RANDOM BUFFER USAGE (NORMAL):
 FPP12 [0]

FOR A SPECIFIC BUFFER ONLY:
 FPP12 [1] [NNNN]
 WHERE NNNN IS A LEGAL BUFFER DESIGNATOR

4.4 DEVICE SETUP

NONE

4.5 RUNNING

1. CNTR: UPDATED UPON EACH FPP12 INTERRUPT
2. SR10: WHEN SET TO A 1, THE BUFFER CURRENTLY ASSIGNED IS RETAINED.
3. SR11: NO EFFECT

5. ERROR INFORMATION

ERRSA = INCORRECT EXPONENT
 ERRSB = INCORRECT MOST SIGNIFICANT WORD
 ERRSC = INCORRECT LEAST SIGNIFICANT WORD
 ERRSD = CORRECT EXPONENT
 ERRSE = CORRECT MOST SIGNIFICANT WORD
 ERRSF = CORRECT LEAST SIGNIFICANT WORD
 CODE = BUFFER DESIGNATOR

Title SYNOPSIS OF INFO ON DEC/X8 SOFTWARE MODULE (Cont)					Tech Tip Number DEC/X8-TT-2	
All Processor Applicability			Author Don Herbener		Rev g	
			Approval Frank Purcell		Date 02/14/73	
Cross Reference						

1. HSRHSP MODULE DESCRIPTION

"HSRHSP" IS A DEC/X8 SOFTWARE MODULE WHICH EXERCISES THE STANDARD DEC HIGH SPEED READER AND/OR PUNCH OPTIONS. THE READER AND PUNCH MAY BE RUN SEPARATELY OR SIMULTANEOUSLY DEPENDENT ON MODULE INITIALIZATION. THE ONLY PATTERN USED IS THE "SPECIAL BINARY COUNT PATTERN" WHICH CONSISTS OF A BINARY COUNT PATTERN WITH EVERY SECOND FRAME EQUAL TO THE LOGICAL COMPLEMENT OF THE PRECEDING FRAME; E.G. 1,376, 2,376, 3,374, ETC.

THE PUNCH PORTION PUNCHES ABOUT A 3/4 INCH THICKNESS OF TAPE INCLUDING LEADER AND TRAILER. WHEN THE PUNCH IS DONE AND THE READER IS NOT BUSY THE JOB IS AUTOMATICALLY KILLED AND SO INDICATED BY A STATUS ERROR REPORT (CODE:0000).

THE READER PORTION READS A TAPE PREVIOUSLY PUNCHED BY THE PUNCH ROUTINE OR THE "SPECIAL BINARY COUNT PATTERN" TEST TAPE (MAINDEC-00-D2G4-PT). THE READER ROUTINE WILL ACCEPT NO MORE THAN 1000(8) FRAMES OF LEADER. END OF TAPE IS DETECTED BY AN UNEXPECTED "1000" FRAME OF TAPE. AT THAT TIME IF THE PUNCH IS NOT BUSY, THE JOB WILL BE KILLED AND SO REPORTED AS A STATUS ERROR (CODE 0000). ANY OTHER ERRORS ARE REPORTED AS DESCRIBED IN PARAGRAPH 5 BELOW.

NOTE

BOTH THE READER AND PUNCH ARE OPERATED AT THE HIGHEST SPEED POSSIBLE. NO INTENTIONAL STALLS ARE GENERATED. IT IS IMPOSSIBLE TO FEED THE TAPE FROM THE PUNCH DIRECTLY INTO THE READER.

2. REQUIREMENTS

1. PROCESSORS: PDP-8, 8/i, 8/L, 8/E, 8/M AND PDP-12.
2. OPTIONS: STANDARD DEC HIGH SPEED READER AND/OR PUNCH TYPES "PR", "PP", AND "PC".
3. SPECIAL: IF NO PUNCH IS AVAILABLE, USE THE "SPECIAL BINARY COUNT PATTERN" TEST TAPE (MAINDEC-00-D2G4-PT).

3. RESTRICTIONS

THE PAPER TAPE BEING PUNCHED MUST NOT BE FED DIRECTLY TO THE READER. TO RUN BOTH THE READER AND PUNCH SIMULTANEOUSLY IT WILL BE NECESSARY TO USE THE PUNCH ALONE TO PRE-PUNCH THE FIRST READER TAPE.

4. OPERATING INFORMATION

4.1 SPECIAL CONSIDERATIONS

IT IS LEGAL TO BUILD TWO OF THESE MODULES INTO THE EXERCISER. ONE SHOULD BE SET UP FOR PUNCH ONLY. THE OTHER FOR READER ONLY. THIS WILL ALLOW THE READER TO BE USED MORE FREQUENTLY.

4.2 BUILDING

1. JOB TYPE: INTERRUPT DRIVEN
2. PRIORITY: NOT CRITICAL, HOWEVER THE READER WILL CAUSE FAIRLY FREQUENT INTERRUPTS (ABOUT ONCE EVERY 3.3 MILLI-SECONDS FOR A 300 CPS READER).
3. JOB SLOTS: ANY EXISTENT JOB SLOT; 2 PAGES REQUIRED.
4. STANDARD DEVICE CODES: READER-0010, PUNCH-0020.

4.3 INITIALIZING

1. PRESET CONDITION: IF THE JOB IS NEVER INITIALIZED IT WILL RUN BOTH THE READER AND THE PUNCH.
2. PARAMETER INPUT: AFTER "HSRHSP" IS PRINTED THE USER SHOULD TYPE THE NUMERICAL CODE INDICATED TO ACHIEVE THE DESIRED RESULTS.

CODE

RESULTS

- | | |
|---|---|
| 0 | READER AND PUNCH ARE RUN SIMULTANEOUSLY |
| 1 | PUNCH ALONE |
| 2 | READER ALONE |

4.4 DEVICE SETUP

1. THE READER MUST BE ON LINE WITH A SPECIAL BINARY COUNT PATTERN TAPE INSERTED ON LEADER CODE BUT NEAR THE START OF THE PATTERN.
2. THE PUNCH MUST BE ON (IF APPLICABLE).

4.5 RUNNING

1. CNTR: UPDATED WHENEVER AN INTERRUPT IS ACKNOWLEDGED.
2. SR10: NO EFFECT
3. SR11: NO EFFECT

5. ERROR INFORMATION

ALL ERRORS ARE REPORTED IN THE STANDARD STATUS ERROR FORMAT.

5.1 ERROR SYMBOL DEFINITIONS

1. CODE: 0000 INDICATES END OF JOB. NO SX: WORDS WILL BE REPORTED.
7777 INDICATES A READER ERROR OTHER THAN END OF JOB. SX: WORDS ARE REPORTED AS SHOWN BELOW.
2. SA: CHARACTER EXPECTED IN BITS 4-11.
3. SB: CHARACTER READ IN BITS 4-11.

5.2 RECOVERY PROCEDURE

THE JOB MAY BE RESTARTED AFTER A CODE 0000 ERROR. CODE 7777 ERRORS IMPLY A READER AND/OR PRIOR PUNCH FAILURE. IN THIS CASE THE JOB WILL CONTINUE RUNNING.

digital	FIELD SERVICE TECHNICAL MANUAL				Option or Designator
	12 Bit <input checked="" type="checkbox"/>	16 Bit <input type="checkbox"/>	18 Bit <input type="checkbox"/>	36 Bit <input type="checkbox"/>	DEC/X8

Title SYNOPSIS OF INFO ON DEC/X8 SOFTWARE MODULES (Cont)				Tech Tip Number	DEC/X8-TT-2			
All	Processor Applicability			Author	Don Herbener	Rev	0	Cross Reference
				Approval	Frank Purcell	Date	02/14/73	

1. MRI08A MODULE DESCRIPTION

"MRI08A" IS A DEC/X8 SOFTWARE MODULE WHICH TESTS THE AND, TAD, ISZ AND JMS INSTRUCTIONS. THE METHODS USED ARE OBVIOUS, HENCE ALL SPECIFICS MAY BE GAINED FROM THE PROGRAM LISTING.

2. REQUIREMENTS

1. PROCESSORS: PDP-8, 8/I, 8/L, 8/E, 8/M AND PDP-12.
2. OPTIONS: NONE
3. SPECIAL: NONE

3. RESTRICTIONS

NONE

4. OPERATING INFORMATION

4.1 SPECIAL CONSIDERATIONS

NONE

4.2 BUILDING

1. JOB TYPE: BACKGROUND

2. PRIORITY: MUST HAVE LOWER PRIORITY THAN ALL INTERRUPT DRIVEN JOBS; OTHERWISE UNIMPORTANT.
3. JOB SLOTS: ANY EXISTENT JOB SLOT; 2 PAGES REQUIRED.

4.3 INITIALIZING

NONE

4.4 DEVICE SETUP

NONE

4.5 RUNNING

1. CNTR: UPDATED AT THE COMPLETION OF ONE PASS THROUGH THE ENTIRE MODULE.
2. SR10: NO EFFECT
3. SR11: NO EFFECT

5. ERROR INFORMATION

ALL ERRORS ARE CONSIDERED FATAL AND RESULT IN A PROGRAM HALT. ANY RECOVERY IS QUESTIONABLE.

Title SYNOPSIS OF INFO ON DEC/X8 SOFTWARE MODULES (Cont)						Tech Tip Number DEC/X8-TT-2		
All	Processor Applicability					Author Don Herbener Rev n		Cross Reference
						Approval Frank Purcell Date 02/14/73		

1. MULTTY MODULE DESCRIPTION

"MULTTY" IS A DEC/X8 SOFTWARE MODULE WHICH EXERCISES UP TO FOUR TELETYPES OR EQUIVALENT DEVICES WHICH ARE INDIVIDUALLY CONTROLLED THROUGH INTERFACES TYPES KL8, PT08 OR EQUIVALENT.

TELEPRINTER EXERCISING IS ACCOMPLISHED VIA AN OUTPUT PATTERN WHICH DISPLAYS ONE FULL LINE OF EACH EXISTENT CHARACTER STARTING WITH CODE 040, THEN 041, ETC.

THE TTY LEVEL (0-3) FOLLOWED BY A COLON IS PRINTED AT THE BEGINNING OF EACH LINE.

```

N:          . . . . .
N: !!!!! . . . . . !!!!!
N: ~~~~~ . . . . . ~~~~~
N: ##### . . . . . #####
N: . . . . .
N: ~~~~~ . . . . . ~~~~~
ETC.

```

ANY CHARACTER INPUT VIA THE KEYBOARD OR READER IMMEDIATELY REPLACES THE CURRENT PATTERN CHARACTER, AND THE PATTERN CONTINUES THE SEQUENCE WITH THE NEW CHARACTER.

2. REQUIREMENTS

1. PROCESSORS: PDP-8, 8/I, 8/L, 8/E, 8/M AND PDP-12

2. OPTIONS: FROM ONE TO FOUR TELETYPES WITH INTERFACES TYPES KL8, PT08 OR EQUIVALENT.

3. SPECIAL: NONE

3. RESTRICTIONS

NONE

4. OPERATING INFORMATION

4.1 SPECIAL CONSIDERATIONS

NONE

4.2 BUILDING

1. JOB TYPE: INTERRUPT DRIVEN

2. PRIORITY: NON-CRITICAL

3. JOB SLOTS: ANY EXISTENT JOB SLOT; 2 PAGES REQUIRED.

4. STANDARD DEVICE CODES: NONE. ALL DEVICE CODES ARE INPUT VIA INITIALIZATION.

4.3 INITIALIZING

AFTER THE TTY LEVEL (0-3) IS PRINTED, TYPE THE FOLLOWING:

```

MULTTY
0 [AA] [BB]
1 [AA] [BB]
2 [AA] [BB]
3 [AA] [BB]

```

WHERE "AA" IS THE KEYBOARD DEVICE CODE AND "BB" THE TELEPRINTER DEVICE CODE FOR THE TTY AT THE INDICATED LEVEL. TYPE "00" FOR ANY KEYBOARD OR TELEPRINTER LEVEL WHICH DOES NOT HAVE A DEVICE. LEVELS 0-3 MUST BE INITIALIZED.

IN ADDITION, THE FOLLOWING LOCATIONS MAY BE CHANGED AS INDICATED USING RELATIVE 10. ANY CHANGES MADE APPLY TO ALL TELETYPES EXERCISED BY THIS MODULE.

1. CHANGE "FILLER" (0342) TO THE ONE'S COMPLEMENT OF THE NUMBER OF NULL FILLER CHARACTERS AFTER CR-LF. PRESET FOR 1 FILLER.

2. CHANGE "LENGTH" (0343) TO THE ONE'S COMPLEMENT OF THE NUMBER OF COLUMNS MINUS 2. PRESET FOR 72(10) COLUMNS.

3. CHANGE "CARNUM" (0344) TO THE TWO'S COMPLEMENT OF THE NUMBER OF PRINTABLE CHARACTERS. PRESET FOR 64(10) CHARACTERS.

4.4 DEVICE SETUP

ALL TELETYPES TO BE EXERCISED MUST BE ON LINE.

4.5 RUNNING

1. CNTR: UPDATED EACH TIME A LINE IS COMPLETED ON A TELEPRINTER.

2. SR10: NO EFFECT

3. SR11: NO EFFECT

5. ERROR INFORMATION

ALL ERROR DETECTION IS VISUAL.

digital	FIELD SERVICE TECHNICAL MANUAL				Option or Designator
	12 Bit <input checked="" type="checkbox"/>	16 Bit <input type="checkbox"/>	18 Bit <input type="checkbox"/>	36 Bit <input type="checkbox"/>	DEC/X8

Title	SYNOPSIS OF INFO ON DEC/X8 SOFTWARE MODULES (Cont)			Tech Tip Number	DEC/X8-TT-2
All	Processor Applicability	Author	Don Herbener	Rev	0
		Approval	Frank Purcell	Date	02/14/73
					Cross Reference

1. NOTFUN MODULE DESCRIPTION

"NOTFUN" IS A DEC/X8 SOFTWARE MODULE WHICH VERIFIES THAT ALL NON-FUNCTIONAL IOT'S WITHIN A GIVEN SYSTEM DO NOT AFFECT THAT SYSTEM WHEN EXECUTED.

THE METHOD USED IS TO EXECUTE ALL IOT'S NOT INCLUDED IN A USER SUPPLIED LIST OF FUNCTIONAL IOT'S AND VERIFYING DIRECTLY THAT THE AC IS UNEFFECTED AND THAT NO SKIP OCCURS. THE DEC/X8 MONITOR AND/OR OTHER EXERCISER MODULES SHOULD DETECT ANY MORE SUBTLE INTERACTIVE PROBLEMS.

2. REQUIREMENTS

1. PROCESSORS: PDP-8, 8/I, 8/L, 8/E, 8/M AND PDP-12
2. OPTIONS: NONE
3. SPECIAL: NONE

3. RESTRICTIONS

NONE

4. OPERATING INFORMATION

4.1 SPECIAL CONSIDERATIONS

NONE

4.2 BUILDING

1. JOB TYPE: BACKGROUND
2. PRIORITY: MUST HAVE LOWER PRIORITY THAN ALL INTERRUPT JOBS; OTHERWISE UN-IMPORTANT.
3. JOB SLOTS: ANY EXISTENT JOB SLOT: 2 PAGES REQUIRED.

4.3 INITIALIZING

AFTER "NOTFUN" IS PRINTED, TYPE "0" FOR A PDP-8/E OR 8/M, OR A "1" FOR A PDP-8, 8/I, 8/L OR PDP-12.

THEN AN OCTAL LISTING STARTING AT "01" WILL BE PRINTED. FOLLOWING THE NUMBERED ITEMS IN THE LIST TYPE ALL EXISTING DEVICE CODES (EXCEPT 00) IN THE SYSTEM UNDER TEST. IF THE SYSTEM HAS EXTENDED MEMORY, DEVICE CODES 20 THROUGH 27 MUST BE SPECIFIED, WHEN COMPLETE TYPE "00" TO SIGNIFY THE END OF INPUT.

BELOW IS A TYPICAL EXAMPLE:

NOTFUN	0	(PDP-8/E)
01	03	(KEYBOARD)
02	04	(TELEPRINTER)
03	76	(DECTAPE)
04	77	(DECTAPE)
05	66	(LP08/LE8)
06	01	(READER)
07	02	(PUNCH)
10	20	(EXTENDED MEMORY DE- VICE CODES 20-27)
11	21	
12	22	
13	23	
14	24	
15	25	
16	26	
17	27	
20	00	(END OF INPUTS)

4.4 DEVICE SETUP

NONE

4.5 RUNNING

1. CNTR: UPDATED AFTER EACH IOT IS TESTED.
2. SR10: NO EFFECT
3. SR11: NO EFFECT

5. ERROR INFORMATION

ALL ERRORS ARE REPORTED AS "STAT ERR" AND ARE IN A WAY CONSIDERED FATAL. THE JOB IS THEREFORE AUTOMATICALLY KILLED AFTER ANY ERROR IS DETECTED.

5.1 ERROR SYMBOL DEFINITIONS

CODE:

0000 SETUP ERROR. THE USER HAS SPECIFIED THAT ALL DEVICE CODES ARE USED IN THE SYSTEM UNDER TEST OR THE MODULE HAS NEVER BEEN INITIALIZED.

7776 ILLEGAL CHANGE IN THE AC.

7777 ILLEGAL SKIP

SA: IOT EXECUTED
SB: GOOD AC
SC: AC AFTER IOT WAS EXECUTED

Title SYNOPSIS OF INFO ON DEC/X8 SOFTWARE MODULES						Tech Tip Number DEC/X8-TT-2		
All	Processor Applicability					Author Don Herbener Rev 0		Cross Reference
						Approval Frank Purcell Date 02/14/73		

1. OPERATE MODULE DESCRIPTION

"OPRATE" IS A DEC/X8 SOFTWARE MODULE WHICH TESTS OPERATE INSTRUCTIONS AND THEIR MICROPROGRAMS AS ARE LEGAL IN SPECIFIED FAMILY-OF-8 PROCESSORS. THE MODULE MAY BE "INITIALIZED" TO BYPASS THE ADDITIONAL TESTS FOR ROTATE/IAC MICROPROGRAMS AND/OR SPECIAL PDP-8/E AND 8/M OPERATES. THE METHODS USED ARE OBVIOUS, HENCE ALL SPECIFICS MAY BE GAINED FROM THE PROGRAM LISTING.

2. REQUIREMENTS

1. PROCESSORS: PDP-8, 8/I, 8/L, 8/E, 8/M AND PDP-12.
2. OPTIONS: NONE
3. SPECIAL: NONE

3. RESTRICTIONS

NONE

4. OPERATING INFORMATION

4.1 SPECIAL CONSIDERATIONS

SRS SHOULD BE SET TO 0 WHEN "OPRATE" IS SET UP TO TEST 8/E - 8/M MQ OPERATES.

4.2 BUILDING

1. JOB TYPE: BACKGROUND
2. PRIORITY: MUST BE LOWER THAN ALL INTERRUPT DRIVEN JOBS; OTHERWISE UNIMPORTANT.
3. JOB SLOTS: ANY EXISTENT JOB SLOT; 2 PAGES REQUIRED.

4.3 INITIALIZING

1. PRESET CONDITION: IF "OPRATE" IS NEVER INITIALIZED IT WILL TEST ALL OPERATES AND MICROPROGRAMS WHICH ARE LEGAL ON THE PDP-8/E, 8/M.
2. PARAMETER INPUT: AFTER "OPRATE" IS PRINTED THE USER SHOULD TYPE THE NUMERICAL CODE INDICATED TO ACHIEVE THE RESULTS DESIRED.

CODE	FULL TEST OF:	TESTS INCLUDED:
0	PDP-8	ALL OPERATES LEGAL ON PDP-8
1	PDP-8/I, 8/L, 12	SAME AS "0" PLUS ROTATE/IAC MICRO- PROGRAM TESTS.
2	PDP-8/E, 8/M	SAME AS "1" PLUS MQ AND BSW OPERATES

4.4 DEVICE SETUP

NONE

4.5 RUNNING

1. CNTR: UPDATED AFTER EACH COMPLETE PASS OF THE MODULE.
2. SR10: NO EFFECT
3. SR11: NO EFFECT

5. ERROR INFORMATION

ALL ERRORS ARE CONSIDERED FATAL AND RESULT IN A PROGRAM HALT. ANY RECOVERY IS QUESTIONABLE.

digital	FIELD SERVICE TECHNICAL MANUAL				Option or Designator
	12 Bit <input checked="" type="checkbox"/>	16 Bit <input type="checkbox"/>	18 Bit <input type="checkbox"/>	36 Bit <input type="checkbox"/>	DEC/X8

Title SYNOPSIS OF INFO ON DEC/X8 SOFTWARE MODULES			Tech Tip Number DEC/X8-TT-2		
All	Processor Applicability		Author Don Herbener		Rev 0
			Approval Frank Purcell		Date 02/14/73
			Cross Reference		

1. PLOTTER MODULE DESCRIPTION

"PLOTTER" IS A DEC/X8 SOFTWARE MODULE WHICH EXERCISES AN INCREMENTAL PLOTTER CONTROLLED VIA AN XY&E, VP8/[8/L] OR XY12 INTERFACE.

THE PLOTTER DISPLAYS THE "SIERPINSKY SPACE FILLING CURVE" USING AN ALGORITHM GIVEN IN "SOFTWARE - PRACTICE AND EXPERIENCE" (VOL. 1, PP. 403-410, 1971) AS MODIFIED BY S. RAENOWITZ (D.E.C.).

THE INFORMATION PRESENTED IN THIS MODULE DESCRIPTION IS SUFFICIENT FOR THIS MODULE'S USE. HOWEVER, THE USER IS REFERRED TO THE ABOVE ARTICLE IF A MATHEMATICAL INSIGHT INTO THE GENERATION OF THIS CURVE IS DESIRED.

"PLOTTER" HAS THE ABILITY TO DISPLAY SEVERAL VARIATIONS OF THE CURVE, ANYONE OF WHICH MAY BE CHOSEN BY THE USER VIA MODULE INITIALIZATION (REF. PARAGRAPH 4.3). THE TWO PARAMETERS WHICH CONTROL THESE VARIATIONS ARE "ITERATION" AND "LINE LENGTH".

THE FIGURES WHICH FOLLOW WERE DRAWN BY A PLOTTER (USING THIS MODULE) BUT HAVE BEEN PHOTO REDUCED FOR PRINTING. THEY SHOW THE EFFECT OF THE TWO VARIABLES ON THE CURVE GENERATED. EACH FIGURE IS NOTED WITH THE FOLLOWING INFORMATION.

SYMBOL	DEFINITION
P	ITERATION CODE NUMBER - REFERS TO CURVE COMPLEXITY (01 IS SIMPLEST, 13 MOST COMPLEX). UNFORTUNATELY ONLY UP TO A CERTAIN LEVEL OF COMPLEXITY HAS BEEN SHOWN DUE TO THE SIZE OF THE CURVE GENERATED.
C	LINE LENGTH CODE NUMBER - REFERS TO CURVE COMPONENT SIZE (01 IS SMALLEST, 17 IS LARGEST). THIS NUMBER MULTIPLIED BY 2 THEN MULTIPLIED BY INCREMENT SIZE YIELDS THE LENGTH OF EACH HORIZONTAL AND VERTICAL LINE.

THE CURVE STARTS AT THE POINT INDICATED BY THE ARROW (→) AND CONTINUES FIRST IN THE PEN RIGHT (←Y) DIRECTION. ACTUALLY THE STARTING POINT IS NEAR THE EXTREME PEN RIGHT (←Y), DRUM DOWN (←X) POSITION ON THE CURVE. NOTE THAT ONLY THE FOLLOWING VECTORS ARE USED: (1X), (1Y), (2X), (2Y), (3X,1Y), (3X,2Y) AND (1X,1Y). NO 1/2 INCREMENT VECTORS ARE USED.

THE ENTIRE CURVE IS DRAWN WITHOUT THE PEN EVER LEAVING THE PAPER, HOWEVER, PERIODICALLY A PEN DOWN COMMAND IS GIVEN TO RECOVER FROM USER INTERVENTION, ONCE THE COMPLETE CURVE HAS BEEN DRAWN IT WILL RETRACE AND CONTINUE UNTIL THE JOB HAS BEEN KILLED.

SIERPINSKY SPACE FILLING CURVES

B = ITERATION
C = LINE LENGTH
L = 2BI WHERE L = LENGTH OF EACH HORIZONTAL AND VERTICAL LINE, AND I = THE PLOTTER INCREMENT SIZE.

2. REQUIREMENTS

- PROCESSORS: PDP-8, 8/I, 8/L, 8/E, 8/F, 8/M AND PDP-12
- OPTIONS: XY&E (ENCODED OR UNENCODED), VP8/[8/L] OR XY12 PLOTTER INTERFACE, AND AN INCREMENTAL PLOTTER.
- SPECIAL: NONE

3. RESTRICTIONS

IT IS RECOMMENDED NEVER TO USE A LINE LENGTH PARAMETER OF LESS THAN 3.

4. OPERATING INFORMATION

4.1 SPECIAL CONSIDERATIONS

THE USER SHOULD EXPERIMENT WITH ITERATION AND LINE LENGTH PARAMETERS SET AT LOWER VALUES TO GET A FEEL OF HOW LARGE A GIVEN CURVE IS. SELECTING A LARGE LINE LENGTH AND/OR ITERATION CODE MAY VERY WELL PRODUCE A CURVE WHICH WILL NOT BE CONTAINED WITHIN THE PLOTTING AREA. ACTUALLY THE PRESET VALUES FOR THESE PARAMETERS WOULD BE A GOOD PLACE TO START FOR MOST PLOTTERS. (REF. PARAGRAPH 4.3).

4.2 BUILDING

- JOB TYPE: INTERRUPT DRIVEN
- PRIORITY: ABSOLUTELY NON-CRITICAL.
- JOB SLOTS: JF1 OR JF2 ONLY; 4 PAGES REQUIRED.
- STANDARD DEVICE CODES:
0600 (APPLIES TO ALL)
0610 (VP8/[8/L], XY12 ONLY)
0620 (VP8/[8/L], XY12 ONLY)

4.3 INITIALIZING

REFER TO THE FIGURES IN PARAGRAPH 1 FOR A VISUAL DESCRIPTION OF THE EFFECTS OF THE VARIOUS PARAMETERS. ALSO REVIEW THE STATEMENTS IN PARAGRAPHS 3 AND 4.1.

AFTER "PLOTTER" IS PRINTED, RESPOND TO EACH CODE LETTER AS DEFINED BELOW.

Title SYNOPSIS OF INFO ON DEC/X8 SOFTWARE MODULES (Cont.)										Tech Tip Number DEC/X8-TT-2					
All Processor Applicability										Author Don Herbener		Rev 0		Cross Reference	
										Approval Frank Purcell		Date 02/14/73			

CODE	DESIRED RESULT	RESPONSE	LIMITS	PRESET
A	XY8E UNENCODED XY8E ENCODED VP8/I(S/L), XY12	00	00-02	00
		01		
		02		
B	ITERATION	NN	01-13	05
C	LINE LENGTH	NN	01-17*	04

*SELECTING A LINE LENGTH OF LESS THAN 03 IS NOT ENCOURAGED.

4.4 DEVICE SETUP

THE PLOTTER MUST BE ON LINE. INITIALLY IT IS RECOMMENDED THAT THE PEN BE PLACED ABOUT 3/4 INCH FROM THE EXTREME PEN RIGHT (-Y) POSITION AND THAT A PORTION OF THE PLOT AREA AT LEAST AS LONG AS THE PLOT AREA IS WIDE EXIST IN THE DRUM UP (-X) DIRECTION. ON A FLATBED PLOTTER THIS WOULD CORRESPOND TO THE PEN NEAR THE -Y,-X EXTREME.

4.5 RUNNING

1. CNTR: UPDATED BY EVERY PLOTTER INTERRUPT.
2. SR10: NO EFFECT.
3. SR11: NO EFFECT.

5. ERROR INFORMATION

ALL ERROR DETECTION IS VISUAL.

digital	FIELD SERVICE TECHNICAL MANUAL				Option or Designator
	12 Bit <input checked="" type="checkbox"/>	16 Bit <input type="checkbox"/>	18 Bit <input type="checkbox"/>	36 Bit <input type="checkbox"/>	DEC/X8

Title Synopsis of Info on DEC/X8 Software Modules (cont)				Tech Tip Number	DEC/X8-TT-2
All	Processor Applicability	Author Don Herbener	Rev 0	Cross Reference	
1. PRINTER MODULE DESCRIPTION		Approval Frank Purcell	Date 02/14/73	2. REQUIREMENTS	

"PRINTER" IS A DEC/X8 SOFTWARE MODULE WHICH EXERCISES ANY HARDCOPY OR CRT ASCII DRIVEN DEVICE WHICH IS TELETYPE OR LP08/LE8 PROGRAM COMPATIBLE. "PRINTER" APPLIES AT LEAST TO THE LP08, LE-8, LSB-E, VT06, LA30, TTY AND FUTURE OPTIONS WHICH ARE COMPATIBLE.

EXERCISING IS ACCOMPLISHED VIA THREE OUTPUT PATTERNS AS FOLLOWS.

PATTERN 1 DISPLAYS ONE FULL LINE OF EACH EXISTENT CHARACTER STARTING WITH CODE 040, THEN 041, ETC., AS SHOWN BELOW.

```

!!!! ..... !!!!
" "" ..... " ""
##### ..... #####
. . . . .
-----
ETC.

```

PATTERN 2 IS A ROTATING PATTERN FOLLOWING THE STANDARD CHARACTER SEQUENCE STARTING AT CODE 040 AS SHOWN BELOW.

```

!$ ..... ABC ..... ]!← (ETC)
!"$ ..... ABC ..... ]!← (ETC)
"$ ..... ABC ..... ]!← (ETC)
ETC.

```

PATTERN 3 IS A WEDGE FORMED WITH THE * (ASTERISK) CHARACTER AS SHOWN BELOW.

```

*
*
*
*
* (ONE FULL LINE IN THE CENTER
* OF THE WEDGE)
*
*
*
*

```

1. PROCESSORS: PDP-8, 8/I, 8/L, 8/E, 8/M AND PDP-12

2. OPTIONS: ANY HARDCOPY OR CRT ASCII DEVICE WHICH IS TELETYPE OF LP08/LE8 PROGRAM COMPATIBLE.

3. SPECIAL: NONE

3. RESTRICTIONS

NONE

4. OPERATING INFORMATION

4.1 SPECIAL CONSIDERATIONS

NONE

4.2 BUILDING

1. JOB TYPE: INTERRUPT DRIVEN

2. PRIORITY: NON-CRITICAL; HOWEVER INTERRUPTS MAY OCCUR AT A HIGH FREQUENCY.

3. JOB SLOTS: ANY EXISTENT JOB SLOT; 2 PAGES REQUIRED.

4. STANDARD DEVICE CODES: 0660 STANDARD FOR LP08/LE8.

4.3 INITIALIZING

AFTER THE INDICATED CODE LETTER IS PRINTED RESPOND BY TYPING THE PARAMETER IN THE MANNER SHOWN BELOW. ALL INPUTS ARE OCTAL. NUMBERS WHICH ARE COMMONLY USED ARE 64-0100, 72-0110, 80-0120, 96-0140, AND 132-0204. THE SIGNIFICANCE OF PROGRAM COMPATIBILITY IN PARAMETER "D" IS THE LP08 OR LE-8 SKIP ON ERROR FLAG IOT.

CODE	DEFINITION	RESPONSE	PRESET
A	NUMBER OF CHARACTERS	NNNN	0100
B	*NUMBER OF COLUMNS	NNNN	0120
C	PATTERN	0 = ALL PATTERNS 1 = PATTERN 1 ONLY 2 = PATTERN 2 ONLY 3 = PATTERN 3 ONLY	0
D	TYPE OF PRINTER 1 = LSB-E, TELETYPE OR EQUAL	0 = LP08/LE8	0
E	NUMBER OF FILLER CHARACTERS AFTER CR-LF.	NN (00-77)	00
F	CHARACTER SIZE	0 = NORMAL 1 = ELONGATED (AVAILABLE ON LSB-E OR EQUAL PRINTERS)	0

* (NOTE: ADJUST PARAMETER B FOR ELONGATED CHARACTERS.)

Title SYNOPSIS OF INFO ON DEC/X8 SOFTWARE MODULES (Cont)						Tech Tip Number DEC/X8-TT-2		
All	Processor Applicability					Author Don Herbener Rev 0		Cross Reference
						Approval Frank Purcell Date 02/14/73		

4.4 DEVICE SETUP

THE PRINTER TO BE EXERCISED MUST BE POWERED UP AND PUT ON LINE.

4.5 RUNNING

1. CNTR: UPDATED UPON EACH PRINTER INTERRUPT.

2. SR10: NO EFFECT
3. SR11: NO EFFECT

5. ERROR INFORMATION

THE ONLY DETECTABLE ERROR IN THIS MODULE IS THE SETTING OF THE LP08/LE8 ERROR FLAG. WHEN THIS FLAG IS SENSED IN THE ONE STATE A CODE 7777 "STAT ERR" IS REPORTED AND THE JOB IS AUTOMATICALLY KILLED.

digital	FIELD SERVICE TECHNICAL MANUAL				Option or Designator
	12 Bit <input checked="" type="checkbox"/>	16 Bit <input type="checkbox"/>	18 Bit <input type="checkbox"/>	36 Bit <input type="checkbox"/>	DEC/X8

Title SYNOPSIS OF INFO ON DEC/X8 SOFTWARE MODULES (Cont)				Tech Tip Number	DEC/X8-TT-2
All	Processor Applicability	Author Don Herbener	Rev 0	Cross Reference	
		Approval Frank Purcell	Date 02/14/73		

1. RANMRI MODULE DESCRIPTION

"RANMRI" IS A DEC/X8 SOFTWARE MODULE WHICH TESTS RANDOMLY GENERATED AND, TAD, ISZ, DCA, JMS AND JMP INSTRUCTIONS WHICH DO CURRENT PAGE DIRECT AND INDIRECT MEMORY REFERENCES.

FIRST A RANDOM INSTRUCTION IS GENERATED AND CHECKED FOR VALIDITY, THEN RANDOM DATA IS GENERATED. FINALLY THE INSTRUCTION IS EXECUTED IN A RANDOMLY SELECTED ADDRESS AND CHECKED 500(8) TIMES, THEN THE PROCESS STARTS AGAIN.

2. REQUIREMENTS

1. PROCESSORS: PDP-8, 8/I, 8/L, 8/E, 8/M AND PDP-12.
2. OPTIONS: NONE
3. OPTIONS: NONE

3. RESTRICTIONS

NONE

4. OPERATING INFORMATION

4.1 SPECIAL CONSIDERATIONS

NONE

4.2 BUILDING

1. JOB TYPE: BACKGROUND
2. PRIORITY: MUST HAVE LOWER PRIORITY THAN ALL INTERRUPT JOBS; OTHERWISE UNIMPORTANT.

3. JOB SLOTS: JF1 OR JF2 ONLY; 4 PAGES REQUIRED.

4.3 INITIALIZING

NONE

4.4 DEVICE SETUP

NONE

4.5 RUNNING

1. CNTR: UPDATED AFTER 4096(10) INSTRUCTIONS HAVE BEEN GENERATED AND TESTED.
2. SR10: NO EFFECT
3. SR11: NO EFFECT

5. ERROR INFORMATION

ALL ERRORS ARE CONSIDERED FATAL AND RESULT IN A PROGRAM HALT. ANY RECOVERY IS QUESTIONABLE. HOWEVER, THE FOLLOWING LOCATIONS MAY BE EXAMINED TO DISCOVER THE NATURE OF A FAILURE.

SYMBOL	RELATIVE	CONTENTS SPECIFY THE:
ADDRSS	0355	ABSOLUTE LOCATION IN WHICH THE INSTRUCTION IS EXECUTED.
INSTR	0356	INSTRUCTION WHICH FAILED.
INSADD	0360	ABSOLUTE ADDRESS FINALLY REFERENCED BY THE INSTRUCTION.
DATATH	0362	OPERAND
DATAHR	0363	CONTENTS OF AC PRIOR TO EXECUTION OF THE INSTRUCTION.

Title SYNOPSIS OF INFO ON DEC/X8 SOFTWARE MODULES (Cont)				Tech Tip Number DEC/X8-TT-2	
All		Processor Applicability		Author Don Herbener Rev 0	
				Approval Frank Purcell Date 02/14/73	
Cross Reference					

1. RF08DS MODULE DESCRIPTION

"RF08DS" IS A DEC/X8 SOFTWARE MODULE WHICH EXERCISES AN RF08 DISK SYSTEM WITH UP TO FOUR DISKS. THE MAIN CHARACTERISTICS OF THIS MODULE ARE:

1. READ/WRITE TRANSFERS VARY RANDOMLY FROM 1 TO 1000(B) WORDS.
2. DISK ADDRESSES ARE SELECTED RANDOMLY BETWEEN ADDRESS 00000 OF THE LOWEST NUMBERED DISK SPECIFIED AND ADDRESS 77777 OF THE HIGHEST DISK SPECIFIED.
3. TRANSFERS WILL OCCUR ACROSS DISK BOUNDARIES AND IN THE CASE OF 4 DISK SYSTEMS WILL WRAP AROUND TO DISK 0.
4. EACH PASS OF THE EXERCISER LOOP EXECUTES WRITE/READ/DATA CHECK STARTING AT A RANDOMLY SELECTED DISK ADDRESS.
5. THREE READS ARE DONE IN THE CASE OF A PARITY ERROR.

2. REQUIREMENTS

1. PROCESSORS: PDP-8, 8/I, 8/L, 8/E, 8/M AND PDP-12.
2. OPTIONS: RF08 DISK CONTROL WITH UP TO 4 DISKS.
3. SPECIAL: NONE

3. RESTRICTIONS

NONE.

4. OPERATING INFORMATION

4.1 SPECIAL CONSIDERATIONS

THIS MODULE REQUIRES EXTERNAL BUFFERS.

4.2 BUILDING

1. JOB TYPE: INTERRUPT DRIVEN
2. PRIORITY: NON-CRITICAL BUT SHOULD BE PLACED HIGH ON THE LIST TO PROVIDE GREATER INTERACTION.
3. JOB SLOTS: JF1 OR JF2 ONLY; 4 PAGES REQUIRED.
4. STANDARD DEVICE CODES: 0600, 0610, 0620, 0640
5. STANDARD WORD COUNT: 7750
6. STANDARD CURRENT ADDRESS: 7751

4.3 INITIALIZING

AFTER THE INDICATED CODE LETTER IS PRINTED RESPOND BY TYPING THE PARAMETER IN THE MANNER SHOWN BELOW.
IN ADDITION THE FOLLOWING MODULE LOCATIONS MAY BE CHANGED AS INDICATED TO ACHIEVE THE DESIRED RESULTS.

1. "RECOVER" (0366) MAY BE CHANGED FROM 1007 TO 1003 IN SYSTEMS WHICH HAVE HARDWARE RECOVERY FROM DATA REQUEST LATE ERRORS. THIS CHANGE ENSURES THAT THE MODULE NEVER CONSIDERS THE DRL BIT AS AN ERROR. NO SOFTWARE RECOVERY IS MADE AND NO ERROR REPORT OCCURS. DATA IS CHECKED AS USUAL.
2. "REPORT" (0416) MAY BE CHANGED FROM 1007 TO X00X WHERE ANY CLEAR BITS ARE NOT REPORTED AS ERRORS. BIT ASSIGNMENT IS THE SAME AS FOR THE RF08 STATUS REGISTER.
3. "PARITY" (0711) MAY BE CHANGED FROM 1006 TO 1007 TO INHIBIT DATA CHECKING AFTER PARITY ERRORS.

CODE	DEFINITION	RESPONSE	LIMITS	PRESET
A	LOWEST DISK	N	0-3	0
B	HIGHEST DISK	N	0-3	0
C	TYPE OF DATA	0 FOR RANDOM 1 NNNN FOR CONSTANT	ANY DATA WORD	RANDOM
D	DISK ADDRESS AT WHICH TRANSFER BEGINS	0 FOR RANDOM 1 0NNN NNNN (EMA) (DMA)	LEGAL ADDRESS	RANDOM
E	TRANSFER LENGTH	0 FOR RANDOM 1 NNNN	0001-1000	RANDOM
F	BUFFER TO USE	0 FOR RANDOM 1 NNNN	LEGAL DESIGNATOR	RANDOM

digital	FIELD SERVICE TECHNICAL MANUAL				Option or Designator
	12 Bit <input checked="" type="checkbox"/>	16 Bit <input type="checkbox"/>	18 Bit <input type="checkbox"/>	36 Bit <input type="checkbox"/>	DEC/X8

Title SYNOPSIS OF INFO ON DEC/X8 SOFTWARE MODULES (Cont.)					Tech Tip Number	DEC/X8-TT-2
All	Processor Applicability		Author	Don Herbener	Rev	0
			Approval	Frank Purcell	Date	02/14/73
						Cross Reference

4.4 DEVICE SETUP

WRITE ENABLE ALL DISKS TO BE EXERCISED.

4.5 RUNNING

1. CNTR: UPDATED AFTER A WRITE/READ/DATA CHECK OPERATION IS COMPLETED.
2. SRID: WHEN SET TO A 1, THE BUFFER CURRENTLY ASSIGNED IS RETAINED.
3. SR11: WHEN SET TO A 1, THE CURRENT DISK STARTING ADDRESS IS RETAINED.

5. ERROR INFORMATION

ALL STATUS REGISTER INDICATED ERRORS ARE REPORTED AS STATUS ERRORS, DATA ERRORS IN THE DATA ERROR FORMAT.

5.1 ERROR SYMBOL DEFINITIONS

CODE:

0002 READ
0004 WRITE

0012 FALSE DATA ERROR (BAD SOFTWARE CHECKSUM BUT DATA LOOKED GOOD ON A WORD BY WORD CHECK). THIS TYPE OF ERROR MAY BE REPORTED AFTER A PARITY ERROR AND INDICATES THE FOLLOWING: 1) THE PARITY ERROR STOPPED THE TRANSFER PRIOR TO COMPLETION AND THEREBY CAUSED A SOFTWARE SUMCHECK ERROR; 2) THE DATA TRANSFERRED WAS GOOD.

003X TRANSFER INCOMPLETE (WORD COUNT NON-ZERO BUT NO STATUS REGISTER ERROR BIT IS SET).

0042 THIS ERROR MAY FOLLOW CODE 0032 REPORTS AND INDICATES THAT ALTHOUGH A TRANSFER WAS INCOMPLETE THE DATA THAT WAS TRANSFERRED WAS GOOD.

SA: FINAL CONTENTS OF THE STATUS REGISTER

SB: CURRENT BUFFER DESIGNATOR

SC: INITIAL WORD COUNT

SD: FINAL WORD COUNT

SE: INITIAL CURRENT ADDRESS

SF: FINAL CURRENT ADDRESS

SG: INITIAL EMA

SH: INITIAL DMA

SI: FINAL EMA

SJ: FINAL DMA

DA: BUFFER ADDRESS

DB: GOOD DATA WORD

DC: BAD DATA WORD

Title SYNOPSIS OF INFO ON DEC/X8 SOFTWARE MODULES (Cont)				Tech Tip Number DEC/X8-TT-2		
All	Processor Applicability			Author Don Herbener	Rev 0	Cross Reference
				Approval Frank Purcell	Date 02/14/73	

1. RK8DS MODULE DESCRIPTION

"RK8DS" IS A DEC/X8 SOFTWARE MODULE WHICH EXERCISES AN RK8 DISK SYSTEM WITH UP TO FOUR DRIVES. THE MAIN CHARACTERISTICS OF THIS MODULE ARE:

1. WRITE/READ TRANSFERS VARY RANDOMLY FROM 1 TO 1000(8) WORDS.
2. DISK ADDRESSES ARE SELECTED RANDOMLY BETWEEN ADDRESSES 0000 AND 6177 ON ALL DISKS WITHIN THE SPECIFIED LOW AND HIGH DISK LIMITS.
3. TO ACHIEVE GREATER DATA BREAK THROUGHPUT, RANDOMLY FROM 1 TO 200(8) EXERCISER LOOP PASSES ARE MADE USING TWO ADJACENT TRACKS WITH RANDOM CHANGES TO THE SECTOR, SURFACE AND DRIVE SELECTION ENABLED.
4. THREE READS ARE DONE IN THE CASE OF A PARITY ERROR.

2. REQUIREMENTS

1. PROCESSORS: PDP-8, 8/I, 8/L, 8/E, 8/M AND PDP-12.
2. OPTIONS: RK8 DISK SYSTEM WITH UP TO FOUR RK01 DRIVES.
3. SPECIAL: NONE

3. RESTRICTIONS

NONE

4. OPERATING INFORMATION

4.1 SPECIAL CONSIDERATIONS

THIS MODULE REQUIRES EXTERNAL BUFFERS.

4.2 BUILDING

1. JOB TYPE: INTERRUPT DRIVEN
2. PRIORITY: NON-CRITICAL, BUT SHOULD BE PLACED HIGH ON THE LIST TO PROVIDE GREATER INTERACTION
3. JOB SLOTS: JF1 OR JF2 ONLY; 4 PAGES REQUIRED.
4. STANDARD DEVICE CODES: 0730, 0740, 0750.

4.3 INITIALIZING

AFTER THE INDICATED CODE LETTER IS PRINTED RESPOND BY TYPING THE PARAMETER IN THE MANNER SHOWN BELOW.

IN ADDITION THE FOLLOWING MODULE LOCATIONS MAY BE CHANGED AS INDICATED FOR THE DESIRED RESULT.

1. "REPORT" (0362) MAY BE CHANGED FROM 5776 TO XXXX WHERE ANY CLEAR BITS INHIBIT AN ERROR REPORT FOR THAT CONDITION. BIT ASSIGNMENT IS THE SAME AS THE RK8 STATUS REGISTER.
2. "PARITY" (0730) MAY BE CHANGED FROM 1576 TO 5776 TO INHIBIT DATA CHECKING AFTER A PARITY ERROR.

CODE	DEFINITION	RESPONSE	LIMITS	PRESET
A	LOWEST DISK	N	0-3	0
B	HIGHEST DISK	N	0-3	0
C	TYPE OF DATA	0 FOR RANDOM 1 NNNN FOR CONSTANT	ANY DATA WORD	RANDOM
D	DISK ADDRESS AT WHICH TRANSFER BEGINS	0 FOR RANDOM 1 000N NNNN † (TRK,SUR,SEC) (DSK # IN BITS 9 AND 10)	LEGAL ADDRESS	RANDOM
E	TRANSFER LENGTH	0 FOR RANDOM 1 NNNN	0001-1000	RANDOM
F	BUFFER TO USE	0 FOR RANDOM 1 NNNN	LEGAL DESIGNATOR	RANDOM

digital	FIELD SERVICE TECHNICAL MANUAL				Option or Designator
	12 Bit <input checked="" type="checkbox"/>	16 Bit <input type="checkbox"/>	18 Bit <input type="checkbox"/>	36 Bit <input type="checkbox"/>	DEC/X8

Title SYNOPSIS OF INFO ON DEC/X8 SOFTWARE MODULES (Cont)				Tech Tip Number	DEC/X8-TT-2
All	Processor Applicability		Author Don Herbener	Rev 0	Cross Reference
			Approval Frank Purcell	Date 02/13/73	

4.4 DEVICE SETUP

MAKE READY AND WRITE ENABLE ALL DISKS TO BE EXERCISED.

4.5 RUNNING

1. CNTR: UPDATED AFTER A WRITE/READ/DATA CHECK OPERATION IS COMPLETED.
2. SR10: WHEN A 1, THE BUFFER CURRENTLY ASSIGNED IS RETAINED.
3. SR11: WHEN A 1, THE CURRENT DISK STARTING ADDRESS IS RETAINED.

5. ERROR INFORMATION

ALL STATUS REGISTER ERRORS ARE REPORTED AS STATUS ERRORS, DATA ERRORS IN THE DATA ERROR FORMAT.

5.1 ERROR SYMBOL DEFINITIONS

CODE:

0002 READ
0004 WRITE

0012 FALSE DATA ERROR (BAD SOFTWARE CHECKSUM BUT DATA LOOKED GOOD ON WORD BY WORD CHECK). IN THE CASE OF A PARITY ERROR, THIS CODE INDICATES 1) THE PARITY ERROR STOPPED THE TRANSFER PRIOR TO COMPLETION; AND 2) THE DATA TRANSFERRED WAS GOOD.

003X TRANSFER INCOMPLETE (WORD COUNT NON-ZERO BUT NO STATUS REG. ERROR BIT IS SET.)

0042 THIS MAY FOLLOW CODE 0032 REPORTS AND INDICATES THAT ALTHOUGH A TRANSFER WAS INCOMPLETE, THE DATA THAT WAS TRANSFERRED WAS GOOD.

SA: FINAL STATUS REGISTER
SB: CURRENT BUFFER DESIGNATOR
SC: INITIAL WORD COUNT
SD: FINAL WORD COUNT
SE: INITIAL CURRENT ADDRESS
SF: FINAL CURRENT ADDRESS
SG: INITIAL COMMAND REGISTER
SH: INITIAL TRK, SUR, SEC
SI: FINAL COMMAND REGISTER
SJ: FINAL TRK, SUR, SEC
DA: BUFFER ADDRESS
DB: GOOD DATA WORD
DC: BAD DATA WORD

Title SYNOPSIS OF INFO ON DEC/X8 SOFTWARE MODULES (Cont)				Tech Tip Number DEC/X8-TT-2	
Processor Applicability		Author Don Herbener	Rev 0	Cross Reference	
All		Approval Frank Purcell Date 02/13/73			

1. RKBEDS MODULE DESCRIPTION

"RKBEDS" IS A DEC/X8 SOFTWARE MODULE WHICH EXERCISES AN RK8E DISK SYSTEM WITH UP TO FOUR DISK DRIVES. THE MAIN CHARACTERISTICS OF THIS MODULE ARE:

1. WRITE/READ TRANSFER LENGTH IS RANDOMLY SELECTED FOR 128, 256 OR 512 WORDS. THE 512 WORD TRANSFERS ARE ACCOMPLISHED BY FIRST TRANSFERRING ONE SECTOR IN WRITE OR READ DATA MODE, THEN TRANSFERRING THE NEXT SECTOR IN WRITE OR READ ALL MODE THEREBY ATTEMPTING TO START THE SECOND SECTOR TRANSFER IMMEDIATELY AFTER COMPLETION OF THE FIRST WITHOUT AN INTERVENING DISK REVOLUTION. OF COURSE THE SUCCESS OF THE ABOVE METHOD IS DEPENDENT ON PROCESSOR SPEED AND SYSTEM LOAD.

2. DISK ADDRESSES ARE SELECTED RANDOMLY BETWEEN ADDRESSES 00000 AND 14537 ON ALL DISKS BETWEEN THE SPECIFIED LOW AND HIGH DISK LIMITS.

3. THREE READS ARE DONE IN THE CASE OF A CRC ERROR.

2. REQUIREMENTS

1. PROCESSORS: PDP-8, 8/I, 8/L, 8/E, 8/M AND PDP-12.

2. OPTIONS: RK8-E DISK SYSTEM WITH UP TO FOUR RK05 DRIVES.

3. SPECIAL: NONE

3. RESTRICTIONS

NONE

4. OPERATING INFORMATION

4.1 SPECIAL CONSIDERATIONS

THIS MODULE REQUIRES EXTERNAL BUFFERS.

4.2 BUILDING

1. JOB TYPE: INTERRUPT DRIVEN
2. PRIORITY: NON-CRITICAL, BUT SHOULD BE PLACED HIGH ON THE LIST TO PROVIDE GREATER INTERACTION
3. JOB SLOTS: JF1 OR JF2 ONLY; 4 PAGES REQUIRED.
4. STANDARD DEVICE CODE: 0740

4.3 INITIALIZING

AFTER THE INDICATED CODE LETTER IS PRINTED RESPOND BY TYPING THE PARAMETER IN THE MANNER SHOWN BELOW.

IN ADDITION THE FOLLOWING MODULE LOCATIONS MAY BE CHANGED AS INDICATED FOR THE DESIRED RESULT.

1. "REPORT" (0534) MAY BE CHANGED FROM 3777 TO XXXX WHERE ANY CLEAR BITS INHIBIT AN ERROR REPORT FOR THAT CONDITION. BIT ASSIGNMENT IS THE SAME AS THE RK8-E STATUS REGISTER.
2. "PARITY" (0724) MAY BE CHANGED FROM 3767 TO 3777 TO INHIBIT DATA CHECKING AFTER A CRC ERROR.

CODE	DEFINITION	RESPONSE	LIMITS	PRESET
A	LOWEST DISK	N	0-3	0
B	HIGHEST DISK	N	0-3	0
C	TYPE OF DATA	0 FOR RANDOM 1 NNNN FOR CONSTANT	ANY DATA WORD	RANDOM
D	DISK ADDRESS AT WHICH TRANSFER BEGINS	0 FOR RANDOM 1 000N NNNN ↑ (TRK,SUR,SEC) (DSK # IN BITS 9 AND 10, TRK0 IN BIT 11)	***	RANDOM
E	TRANSFER LENGTH	0 FOR RANDOM 1 NNNN	0200,0400 OR 1000 ONLY	RANDOM
F	BUFFER TO USE	0 FOR RANDOM 1 NNNN	LEGAL DESIGNATOR	RANDOM

***MAXIMUM ADDRESS (TRK/SUR/SEC) ACCEPTABLE IS 14536.

DIGITAL EQUIPMENT CORPORATION

digital	FIELD SERVICE TECHNICAL MANUAL				Option or Designator
	12 Bit <input checked="" type="checkbox"/>	16 Bit <input type="checkbox"/>	18 Bit <input type="checkbox"/>	36 Bit <input type="checkbox"/>	DEC/X8

Title SYNOPSIS OF INFORMATION ON DEC/X8 SOFTWARE MOD				Tech Tip Number	DEC/X8-TT-2
All	Processor Applicability		Author Don Herbener	Rev 0	Cross Reference
			Approval Frank Purcel	Date 02/14/73	

4.4 DEVICE SETUP

MAKE READY AND WRITE ENABLE ALL DISKS TO BE EXERCISED.

4.5 RUNNING

1. CNTR: UPDATED AFTER A WRITE/READ/DATA CHECK OPERATION IS COMPLETED.
2. SR10: WHEN A 1, THE BUFFER CURRENTLY ASSIGNED IS RETAINED.
3. SR11: WHEN A 1, THE CURRENT DISK STARTING ADDRESS IS RETAINED.

5. ERROR INFORMATION

ALL STATUS REGISTER ERRORS ARE REPORTED AS STATUS ERRORS, DATA ERRORS IN THE DATA ERROR FORMAT.

5.1 ERROR SYMBOL DEFINITIONS

CODE:
 0002 READ
 0004 WRITE

0012 FALSE DATA ERROR (BAD SOFTWARE CHECKSUM BUT DATA LOOKED GOOD ON WORD BY WORD CHECK). IN THE CASE OF A CRC ERROR, THIS CODE INDICATES 1) THE CRC ERROR STOPPED THE TRANSFER PRIOR TO COMPLETION; AND 2) THE DATA TRANSFERRED WAS GOOD.

SA: FINAL STATUS REGISTER
 SB: CURRENT BUFFER DESIGNATOR
 SC: INITIAL SOFTWARE WORD COUNT
 SD: FINAL SOFTWARE WORD COUNT
 SE: INITIAL CURRENT ADDRESS
 SF: INITIAL COMMAND REGISTER
 SG: INITIAL DISK ADDRESS REGISTER
 DA: BUFFER ADDRESS
 DB: GOOD DATA WORD
 DC: BAD DATA WORD

Title SYNOPSIS OF INFO ON DEC/X8 SOFTWARE MODULES (Cont)					Tech Tip Number DEC/X8-TT-2	
All	Processor Applicability				Author Don Herbener	Rev 0
					Approval Frank Purcell Date 02/13/73	
						Cross Reference

1. TABECS MODULE DESCRIPTION

"TABECS" IS A DEC/X8 SOFTWARE MODULE WHICH EXERCISES A TAB-E CASSETTE SYSTEM WITH UP TO EIGHT TU60S (SIXTEEN DRIVES). THE MAIN CHARACTERISTICS OF THIS MODULE ARE:

- NORMALLY BLOCK LENGTH IS RANDOM. BLOCK LENGTH VARIES RANDOMLY FROM 1 TO 776 OCTAL WORDS. FOR CONSTANT BLOCK LENGTH REFER TO BLOCK LENGTH PARAGRAPH 4.3.2.
- DATA IS NORMALLY RANDOM. FOR CONSTANT DATA REFER TO DATA PATTERN PARAGRAPH 4.3.3.
- NORMALLY THE TWO DRIVES WITH DEVICE CODE 0700 WILL BE EXERCISED RANDOMLY. FOR MORE DRIVES OR CONSTANT DRIVE CAPABILITIES REFER TO DRIVE SELECTION PARAGRAPH 4.3.1.
- TAPE OPERATIONS PERFORMED ARE: WRITE A FILE GAP (ONLY AT BOT); WRITE; BACKSPACE A BLOCK GAP; READ; COMPARE. REWIND IS USED ONLY WHEN EOT IS SENSED.
- TAPE IS EXERCISED AT THE CURRENT TAPE POSITION. TAPE IS FORCED TO BOT ONLY WHEN EOT IS SENSED.
- THE MODULE WILL HANG IF A DEVICE CODE IS USED WHICH IS NOT ON THE SYSTEM.

2. REQUIREMENTS

- PROCESSORS: PDP-8E, 8F, 8M
- OPTIONS: TAB-E CASSETTE INTERFACE (1-8); TU60 SYSTEM (1-8) WITH UP TO SIXTEEN DRIVES.
- SPECIAL: TWO TO SIXTEEN CERTIFIED CASSETTES.

3. RESTRICTIONS

THIS MODULE IS NOT OPERATIONAL UNDER REVISION A OF THE DEC/X8 MONITOR/BUILDER.

4. OPERATING INFORMATION

4.1 SPECIAL CONSIDERATIONS

THIS MODULE REQUIRES EXTERNAL BUFFERS

4.2 BUILDING

- JOB TYPE: INTERRUPT DRIVEN
- PRIORITY: CRITICAL. MUST BE ONE OF THE HIGHEST PRIORITY MODULES.

3. JOB SLOTS: JF1 OR JF2 ONLY; 4 PAGES REQUIRED

4. STANDARD DEVICE CODE: 0700

4.3 INITIALIZING

THIS MODULE IS SETUP NORMALLY TO RUN A TAB-E CASSETTE SYSTEM WITH A DEVICE CODE OF 0700 UNLESS CHANGED AT BUILDING TIME. THE NORMAL OPERATION WILL BE RANDOM DRIVE SELECTION ON DRIVES A/D, RANDOM BLOCK LENGTH FROM 1 TO 776 (8) WORDS AND RANDOM DATA PATTERNS. TO RUN MORE DRIVES, OR CHANGE DRIVES, OR TO RUN CONSTANT BLOCK LENGTH, OR TO RUN CONSTANT DATA, REFER TO TABLES BELOW FOR CHANGES IN THE MODULE PROGRAM.

4.3.1 DRIVE SELECTION

BELOW IS A TABLE OF 8 LOCATIONS WHICH CONTAIN THE DEVICE CODES OF A TAB-E CASSETTE SYSTEM. INITIALLY ALL EIGHT LOCATIONS ARE SETUP TO A DEVICE CODE OF 0700 UNLESS CHANGED AT BUILD TIME. THIS TABLE IS ACCESSED RANDOMLY TO CHANGE THE DEVICE JOTS' TO THE SAME DRIVES OR RANDOM DRIVES DEPENDING ON THE CONTENTS OF THIS TABLE. TO RUN UP TO 8 TAB-E'S (16 DRIVES) CHANGE THE CONTENTS OF THIS TABLE TO CONTAIN DEVICE CODES FROM 0700 TO 0770. TO RUN TWO TAB-E'S EQUALLY CHANGE 4 LOCATIONS IN THIS TABLE TO THE NEW DEVICE CODE. IF IT IS DESIRED TO RUN ONE TAB-E MORE THAN ANOTHER, JUST ENTER THE DEVICE CODE OF THE ONE TO BE EXERCISED LESS, FEWER TIMES IN THE TABLE.

LOCATION	CONTENTS
0526	0700
0527	0700
0530	0700
0531	0700
0532	0700
0533	0700
0534	0700
0535	0700

IN ADDITION THE FOLLOWING MODULE LOCATION MAY BE CHANGED AS INDICATED TO ACHIEVE THE DESIRED RESULTS.

"REPORT" (0307) MAY BE CHANGED FROM 0376 TO 0XXX WHERE ANY CLEAR BITS IN STATUS B ARE NOT REPORTED AS ERRORS.

4.3.2 BLOCK LENGTH

TO CHANGE FROM RANDOM TO CONSTANT BLOCK LENGTH OR FROM CONSTANT BLOCK LENGTH TO RANDOM BLOCK LENGTH USE THE TABLE BELOW FOR CHANGES TO THE MODULE PROGRAM USING ODT.

digital	FIELD SERVICE TECHNICAL MANUAL				Option or Designator
	12 Bit <input checked="" type="checkbox"/>	16 Bit <input type="checkbox"/>	18 Bit <input type="checkbox"/>	36 Bit <input type="checkbox"/>	DEC/X8

Title SYNOPSIS OF INFO ON DEC/X8 SOFTWARE MODULES (Cont)				Tech Tip Number	DEC/X8-TT-2
All	Processor Applicability		Author Don Herbener	Rev 0	Cross Reference
			Approval Frank Purcell	Date 02/14/73	

JOB NUMBER	TYPE	MODULE LOCATION	CONTENTS
JF1	RANDOM	0741	4516
		1160	XXXX
	CONSTANT	0741	4562
		1160	0002-0777*
JF2	RANDOM	0741	5516
		1160	XXXX
	CONSTANT	0741	5562
		1160	0002-0777*

*CONSTANT BLOCK LENGTH = NUMBER OF WORDS +1.

4.3.3 DATA PATTERN

TO CHANGE FROM RANDOM DATA TO CONSTANT DATA OR FROM CONSTANT DATA BACK TO RANDOM DATA USE THE TABLE BELOW FOR CHANGES TO MODULE PROGRAM USING ODT.

4.4 DEVICE SETUP

ALL DRIVES MUST BE LOADED WITH CASSETTES WRITE ENABLED. REFER TO PARAGRAPH 4.3.1 FOR DRIVE SELECTION.

4.5 RUNNING

- GNTR: UPDATED AFTER A WRITE/BACKSPACE BLOCK GAP/READ/COMPARE OPERATION IS COMPLETED.
- SR10: NO EFFECT
- SR11: NO EFFECT

5. ERROR INFORMATION

ALL STATUS B ERRORS ARE REPORTED IN THE STANDARD STATUS ERROR REPORT FORMAT. DATA ERRORS IN THE DATA ERROR FORMAT. IF A CRC ERROR OCCURRED THE PROGRAM WILL TRY TO REREAD THE BLOCK UP TO 2 RETRIES. THE FIRST ERROR AFTER ROTATION OR ↑ C IS NOT REPORTED SINCE A TIMING ERROR IS EXPECTED (DUE TO THE INTERRUPT SYSTEM BEING OFF FOR A PROLONGED TIME).

5.1 ERROR SYMBOL DESCRIPTION

CODE:

- 0000 SOME KIND OF A STATUS B ERROR
 0001 STATUS B EQUALLED 0 BUT KSDR FAILED TO SKIP.
 0010 FALSE DATA ERROR (BAD SOFTWARE CHECKSUM BUT DATA LOOKED GOOD ON A WORD BY WORD CHECK). THIS TYPE OF ERROR MAY BE REPORTED AFTER A CRC ERROR AND INDICATES THE FOLLOWING: 1) THE CRC ERROR STOPPED DATA TRANSFER PRIOR TO COMPLETION AND THEREBY CAUSED A SOFTWARE SUMCHECK ERROR; 2) THE DATA THAT WAS TRANSFERRED WAS GOOD.

- SA: CONTENTS OF STATUS A REGISTER
 SB: STATUS A REGISTER READ BACK AFTER KLSA COMMAND (1'S COMPLEMENT)
 SC: EXPECTED STATUS B
 SD: RECEIVED STATUS B
 SE: BUFFER DESIGNATOR
 SF: INITIAL WORD COUNT (POSITIVE NUMBER)
 SG: FINAL WORD COUNT (THE POSITIVE NUMBER OF WORDS ACTUALLY READ)
 SH: IOT DEVICE CODE
 DA: BUFFER ADDRESS
 DB: GOOD DATA WORD
 DC: BAD DATA WORD

Title SYNOPSIS OF INFO ON DEC/X8 SOFTWARE MODULES (Cont.)						Tech Tip Number DEC/X8-TT-2		
All	Processor Applicability					Author <u>Don Herbener</u> Rev <u>0</u>		Cross Reference
						Approval <u>Frank Purcell</u> Date <u>02/14/73</u>		

JOB NUMBER	TYPE	MODULE LOCATION	CONTENTS
JF1	RANDOM	0742	4516
		1161	4516
		0252	XXXX
	CONSTANT	0742	3770
		1161	3770
		0252	0NNN (8 BIT DATA WORD)
JF2	RANDOM	0742	5516
		1161	5516
		0252	XXXX
	CONSTANT	0742	4770
		1161	4770
		0252	0NNN (8 BIT DATA WORD)

digital	FIELD SERVICE TECHNICAL MANUAL				Option or Designator
	12 Bit <input checked="" type="checkbox"/>	16 Bit <input type="checkbox"/>	18 Bit <input type="checkbox"/>	36 Bit <input type="checkbox"/>	DEC/X8

Title SYNOPSIS OF INFO ON DEC/X8 SOFTWARE MODULES (Cont)				Tech Tip Number	DEC/X8-TT-2
All	Processor Applicability	Author Don Herbener	Rev 0	Cross Reference	
		Approval Frank Purcell	Date 02/14/73		

1. TC01DT MODULE DESCRIPTION

"TC01DT" IS A DEC/X8 SOFTWARE MODULE WHICH EXERCISES A TC01/TC08 DECTAPE SYSTEM WITH UP TO EIGHT TRANSPORTS. THE MAIN CHARACTERISTICS OF THIS MODULE ARE:

- ALL READ/WRITE TRANSFERS CONSIST OF 777(8) WORDS AND UTILIZE EXTERNAL BUFFERS. THE FIRST LOCATION IN THE ASSIGNED BUFFER IS RESERVED FOR CURRENT BLOCK BREAK IN DURING SEARCH.
- SEARCH OPERATIONS ARE IN NORMAL MODE, BOTH DIRECTIONS.
- READ/WRITE OPERATIONS ARE IN CONTINUOUS MODE, BOTH DIRECTIONS.
- ALL DRIVES WITHIN THE LIMITS OF THE LOWEST AND HIGHEST NUMBERED DRIVES (DRIVE "8" = "0" IS LOW) SPECIFIED ARE RANDOMLY UTILIZED.
- ALL BLOCKS WITHIN THE LIMITS OF THE LOWEST-3 AND HIGHEST+3 BLOCKS SPECIFIED ARE SEQUENTIALLY USED.
- THE OPERATIONS AT EACH BLOCK CONSIST OF WRITE/READ/CHECK FORWARD, THEN WRITE/READ/CHECK REVERSE.
- THREE READS ARE DONE IN THE CASE OF A PARITY ERROR.

2. REQUIREMENTS

- PROCESSORS: PDP-8, 8/I, 8/L, 8/E, 8/M AND PDP-12(I).
- OPTIONS: TC01 OR TC08 DECTAPE CONTROL WITH UP TO EIGHT DRIVES (TU55 OR TU56).
- SPECIAL: STANDARD PDP-8 FORMAT DECTAPES ARE RECOMMENDED (2702 BLOCKS, 201 WORDS EACH), NO GUARANTEE IS MADE FOR DECTAPES WITH ANY OTHER FORMAT.

3. RESTRICTIONS

WHEN OPERATING UNDER REVISION A OF THE DEC/X8 MONITOR/BUILDER, CHANGE TC01DT LOCATIONS 0417 AND 0420 FROM 7000 (NOP) TO 7240 AND 3456 RESPECTIVELY.

4. OPERATING INFORMATION

4.1 SPECIAL CONSIDERATIONS

THIS MODULE REQUIRES AND USES EXTERNAL BUFFERS.

4.2 BUILDING

- JOB TYPE: INTERRUPT DRIVEN
- PRIORITY: CRITICAL, MUST BE THE HIGHEST OR ONE OF THE HIGHEST PRIORITY MODULES DUE TO INHERENT HARDWARE DESIGN FEATURES.
- JOB SLOTS: JF1 OR JF2 ONLY; 4 PAGES REQUIRED.
- STANDARD DEVICE CODES: 0760, 0770
- STANDARD WORD COUNT: 7754
- STANDARD CURRENT ADDRESS: 7755

4.3 INITIALIZING

AFTER THE INDICATED CODE LETTER IS PRINTED RESPOND BY TYPING THE PARAMETER IN THE MANNER SHOWN BELOW.

IN ADDITION THE FOLLOWING MODULE LOCATIONS MAY BE CHANGED AS INDICATED TO ACHIEVE THE DESIRED RESULTS.

- "REPORT" (0425) MAY BE CHANGED FROM 7700 TO XX00 WHERE ANY CLEAR BITS ARE NOT REPORTED AS ERRORS. BIT ASSIGNMENT IS THE SAME AS IN TC01/TC08 DECTAPE'S STATUS B REGISTER.
- "PARITY" (0734) MAY BE CHANGED FROM 3500 TO 7700 TO INHIBIT CHECKING DATA AFTER A DECTAPE PARITY ERROR.

Title SYNOPSIS OF INFO ON DEC/X8 SOFTWARE MODULES (Cont)						Tech Tip Number DEC/X8-TT-2		
All	Processor Applicability					Author Don Herbener Rev 0		Cross Reference
						Approval Frank Purcell		

CODE	DEFINITION	RESPONSE	LIMITS	PRESET
A	LOWEST DRIVE	N	0-7	0
B	HIGHEST DRIVE	N	0-7	0
C	LOWEST BLOCK	0 FOR NO CHANGE 1 NNNN FOR NEW	0003-2675	2600
D	HIGHEST BLOCK	0 FOR NO CHANGE 1 NNNN FOR NEW	0004-2676	2676
E	TYPE OF DATA	0 FOR RANDOM 1 NNNN FOR CONSTANT	ANY DATA WORD	RANDOM
F	BUFFER TO USE	0 FOR RANDOM 1 NNNN	LEGAL DESIGNATOR	RANDOM

digital	FIELD SERVICE TECHNICAL MANUAL				Option or Designator
	12 Bit <input checked="" type="checkbox"/>	16 Bit <input type="checkbox"/>	18 Bit <input type="checkbox"/>	36 Bit <input type="checkbox"/>	DEC/X8

Title SYNOPSIS OF INFO ON DEC/X8 SOFTWARE MODULES (Cont)				Tech Tip Number	DEC/X8-TT-2
All	Processor Applicability	Author Don Herbener	Rev 0	Cross Reference	
		Approval Frank Purcell	Date 02/14/73		

4.4 DEVICE SETUP

ALL DRIVES TO BE EXERCISED MUST BE SWITCHED TO REMOTE AND WRITE ENABLED WITH TAPE IN PLACE.

4.5 RUNNING

1. CNTR: UPDATED AFTER A WRITE/READ/CHECK OPERATION IS COMPLETED.
2. SR10: WHEN SET TO A 1, THE BUFFER CURRENTLY ASSIGNED IS RETAINED.
3. SR11: WHEN SET TO A 1, THE DRIVE CURRENTLY IN USE IS RETAINED.

5. ERROR INFORMATION

ALL STATUS B ERRORS ARE REPORTED IN THE STANDARD STATUS ERROR FORMAT, DATA ERRORS IN THE DATA ERROR FORMAT. THE FIRST STATUS ERROR AFTER ROTATION OR I/O IS NOT REPORTED SINCE A TIMING ERROR IS EXPECTED (DUE TO THE INTERRUPT SYSTEM BEING OFF FOR A PROLONGED TIME).

003X TRANSFER INCOMPLETE (WORD COUNT NON-ZERO BUT NO STATUS B ERROR BIT IS SET).

004Z THIS ERROR MAY FOLLOW CODE 003Z REPORTS AND INDICATES THAT ALTHOUGH A TRANSFER WAS INCOMPLETE THE DATA THAT WAS TRANSFERRED WAS GOOD.

- SA: FINAL CONTENTS OF STATUS B REGISTER.
 SB: CURRENT BUFFER DESIGNATOR
 SC: INITIAL WORD COUNT
 SD: FINAL WORD COUNT
 SE: INITIAL CURRENT ADDRESS
 SF: FINAL CURRENT ADDRESS
 SG: CURRENT DRIVE IN BITS 0-2.
 SH: CURRENT BLOCK NUMBER AT WHICH TRANSFERS START.
 SI: FINAL CONTENTS OF STATUS A REGISTER.
 DA: BUFFER ADDRESS
 DB: GOOD DATA WORD
 DC: BAD DATA WORD

5.1 ERROR SYMBOL DEFINITIONS

CODE:

- 0000 SEARCH OPERATION
 0002 READ OPERATION
 0004 WRITE OPERATION

0012 FALSE DATA ERROR (BAD SOFTWARE CHECKSUM BUT DATA LOOKED GOOD ON A WORD BY WORD CHECK.) THIS TYPE OF ERROR MAY BE REPORTED AFTER A PARITY ERROR AND INDICATES THE FOLLOWING: 1) THE PARITY ERROR STOPPED THE TRANSFER PRIOR TO COMPLETION AND THEREBY CAUSED A SOFTWARE SUMCHECK ERROR; 2) THE DATA THAT WAS TRANSFERRED WAS GOOD.

5.2 TROUBLESHOOTING HINT

THE REURRENCE OF SELECT ERRORS IS A PROBLEM WHICH MAY BE DIFFICULT TO DIAGNOSE. THE FOLLOWING STEPS MAY LEAD TO A SOLUTION.

1. KILL THE JOB.
2. CHANGE MODULE LOCATIONS 1030 TO 7000 AND 1031 TO 6766.
3. RUN THE JOB.
4. IF THE PROBLEM "DISAPPEARS" CHECK OUT THE XSA BY TIME USING THE ORIGINAL CODE.

Title SYNOPSIS OF INFO ON DEC/X8 SOFTWARE MODULES (Cont)						Tech Tip Number DEC/X8-TT-2
All	Processor Applicability			Author Don Herbener	Rev 0	Cross Reference
				Approved Frank Purcell	Date 02/14/73	

1. TC12LT MODULE DESCRIPTION

"TC12LT" IS A DEC/X8 SOFTWARE MODULE WHICH EXERCISES A TC12 LINCINTEPE SYSTEM WITH UP TO EIGHT TRANSFERS. THE MAIN CHARACTERISTICS OF THIS MODULE ARE:

1. ALL READ/WRITE TRANSFERS CONSIST OF 400(8) WORDS AND UTILIZE EXTERNAL BUFFERS.
2. ALL OPERATIONS PERFORMED ARE IN EXTENDED OPERATIONS MODE AND UTILIZE THE EXTENDED ADDRESSING MODE.
3. ALL DRIVES WITHIN THE LIMITS OF THE LOWEST AND HIGHEST NUMBERED DRIVES SPECIFIED ARE RANDOMLY UTILIZED.
4. ALL BLOCKS WITHIN THE LIMITS OF THE LOWEST AND HIGHEST BLOCKS SPECIFIED ARE SEQUENTIALLY USED.
5. THE OPERATIONS AT EACH BLOCK CONSIST OF WRITE/READ/CHECK.
6. THREE READS ARE DONE IN THE CASE OF A TRANSFER CHECK ERROR.
7. ALL OPERATIONS IN LINC MODE ARE DONE WITH THE INTERRUPT SYSTEM OFF.

2. REQUIREMENTS

1. PROCESSORS: PDP-12
2. OPTIONS: TC12 LINCINTEPE PROCESSOR WITH UP TO EIGHT DRIVES (TU55 OR TU56).
3. SPECIAL: STANDARD PDP-12 FORMAT LINCINTEPE ARE REQUIRED (1000 OR 1600 BLOCKS, 400 WORDS PER BLOCK).

3. RESTRICTIONS

NONE.

4. OPERATING INFORMATION

4.1 SPECIAL CONSIDERATIONS

THIS MODULE REQUIRES EXTERNAL BUFFERS.

4.2 BUILDING

1. JOB TYPE: INTERRUPT DRIVEN
2. PRIORITY: NON-CRITICAL
3. JOB SLOTS: JF1 OR JF2 ONLY; 4 PAGES REQUIRED

4.3 INITIALIZING

AFTER THE INDICATED CODE LETTER IS PRINTED, RESPOND BY TYPING THE PARAMETER IN THE MANNER SHOWN BELOW.

IN ADDITION LOCATION "PARITY" (0717) MAY BE CHANGED FROM 0000 TO 7777 TO INHIBIT DATA CHECKING AFTER A TRANSFER CHECK ERROR.

4.4 DEVICE SETUP

ALL DRIVES TO BE EXERCISED MUST BE SWITCHED TO REMOTE AND WRITE ENABLED WITH TAPE IN PLACE.

4.5 RUNNING

1. CNTR: UPDATED AFTER A WRITE/READ/CHECK OPERATION IS COMPLETED.
2. SR10: WHEN SET TO A 1, THE BUFFER CURRENTLY ASSIGNED IS RETAINED.
3. SR11: WHEN SET TO A 1, THE DRIVE CURRENTLY IN USE IS RETAINED.

5. ERROR INFORMATION

TRANSFER CHECK ERRORS ARE REPORTED IN THE STANDARD STATUS ERROR FORMAT, DATA ERRORS IN THE DATA ERROR FORMAT.

5.1 ERROR SYMBOL DEFINITIONS

CODE:
0002 READ OPERATION

CODE	DEFINITION	RESPONSE	LIMITS	PRESET
A	LOWEST DRIVE	N	0-7	0
B	HIGHEST DRIVE	N	0-7	0
C	LOWEST BLOCK	0 FOR NO CHANGE 1 NNNN FOR NEW	0000-1576	0770
D	HIGHEST BLOCK	0 FOR NO CHANGE 1 NNNN FOR NEW	0001-1577	0777
E	TYPE OF DATA	0 FOR RANDOM 1 NNNN FOR CONSTANT	ANY DATA WORD	RANDOM
F	BUFFER TO USE	0 FOR RANDOM 1 NNNN	LEGAL DESIGNATOR	RANDOM

DIGITAL EQUIPMENT CORPORATION

digital	FIELD SERVICE TECHNICAL MANUAL				Option or Designator
	12 Bit <input checked="" type="checkbox"/>	16 Bit <input type="checkbox"/>	18 Bit <input type="checkbox"/>	36 Bit <input type="checkbox"/>	DEC/X8

Title SYNOPSIS OF INFO ON DEC/X8 SOFTWARE MODULES (Cont)				Tech Tip Number	DEC/X8-TT-2
All	Processor Applicability	Author Don Herbener	Rev 0	Cross Reference	
		Approval Frank Purcell	Date 02/14/73		

0004 WRITE OPERATION

SD: INITIAL XOB

0012 FALSE DATA ERROR (BAD SOFTWARE CHECKSUM BUT DATA LOOKED GOOD ON WORD BY WORD CHECK.)

SE: TAPE INSTRUCTION (WRI OR RDE)

SF: CURRENT BLOCK NUMBER

SG: FINAL XOB

SA: FINAL CONTENTS OF TAC

DA: BUFFER ADDRESS

SB: CURRENT BUFFER DESIGNATOR

DB: GOOD DATA WORD

SC: CURRENT DRIVE IN BITS 9-11

DC: BAD DATA WORD

Title SYNOPSIS OF INFO ON DEC/X8 SOFTWARE MODULES (Cont)						Tech Tip Number	DEC/X8-TT-2
All	Processor Applicability		Author Don Herbener	Rev 0	Cross Reference		
			Approval Frank Purcell	Date 02/14/73			

1. TC58MT MODULE DESCRIPTION

"TC58MT" IS A DEC/X8 SOFTWARE MODULE WHICH EXERCISES A TC58 DECMAGTAPE SYSTEM WITH UP TO EIGHT TRANSPORTS. THE MAIN CHARACTERISTICS OF THIS MODULE ARE:

- RECORD LENGTH VARIES RANDOMLY FROM 30 TO 1000 WORDS OCTAL.
- FILE LENGTH VARIES RANDOMLY FROM 1 TO 200 RECORDS OCTAL. (EOF IS NOT WRITTEN.)
- THE TAPE OPERATIONS PERFORMED ARE WRITE/READ-COMPARE/READ FOR EACH "FILE". SPACE REVERSE IS USED TO MOVE FROM THE END TO THE BEGINNING OF THE FILE. REWIND IS USED ONLY WHEN EOT IS SENSED.
- ALL OPERATIONS ARE DONE AT 800 BPI, NORMAL GAP IN CORE DUMP MODE (9 TRACK TREATED AS 7 TRACK). GAP AND DENSITY MAY BE CHANGED BY THE USER AS INDICATED LATER; HOWEVER, NO PROVISIONS HAVE BEEN INCLUDED TO OPERATE IN STANDARD 9 TRACK COMPATIBLE MODE.
- ALL DRIVES WITHIN THE LIMITS OF THE LOWEST AND HIGHEST DRIVES SPECIFIED ARE RANDOMLY UTILIZED.
- UNLIKE MANY OTHER DECMAGTAPE EXERCISERS, THIS MODULE STARTS AT THE CURRENT TAPE POSITION. TAPE IS FORCED TO BOT ONLY WHEN EOT IS SENSED.
- CONTINUE MODE IS NEVER UTILIZED.
- THE MODULE WILL HANG IF A SELECTED DRIVE IS OFF LINE OR OTHERWISE NOT READY.

2. REQUIREMENTS

- PROCESSORS: PDP-8, 8/I, 8/L, 8/E, 8/M AND PDP-12.

- OPTIONS: TC58 DECMAGTAPE CONTROL WITH UP TO EIGHT 7 AND/OR 9 TRACK TRANSPORTS (TU20, TU30, TU10 OR EQUIVALENTS).

- SPECIAL: INDUSTRY CERTIFIED STANDARD MAGNETIC TAPE.

3. RESTRICTIONS

- 9 TRACK COMPATIBLE MODE MAY NOT BE USED. ALL 9 TRACK TRANSPORTS WILL BE OPERATED IN CORE DUMP MODE.

4. OPERATING INFORMATION

4.1 SPECIAL CONSIDERATIONS

THIS MODULE REQUIRES EXTERNAL BUFFERS.

4.2 BUILDING

- JOB TYPE: INTERRUPT DRIVEN
- PRIORITY: SHOULD BE ASSIGNED THE LOWEST INTERRUPT PRIORITY.
- JOB SLOTS: JF1 OR JF2 ONLY; 4 PAGES REQUIRED.
- STANDARD DEVICE CODES: 0700, 0710, 0720
- STANDARD WORD COUNT: 7752
- STANDARD CURRENT ADDRESS: 7753

4.3 INITIALIZING

AFTER THE INDICATED CODE LETTER IS PRINTED RESPOND BY TYPING THE PARAMETER IN THE MANNER SHOWN BELOW.

IN ADDITION LOCATION "K606A" (0325) MAY BE CHANGED TO SPECIFY ANY LEGAL GAP OR DENSITY SELECTION EXCEPT 9 TRACK COMPATIBLE. CORE DUMP MODE MUST ALWAYS BE USED. BIT ASSIGNMENT IS THE SAME AS THE COMMAND REGISTER. CONTINUE MODE MAY BE FORCED BY CHANGING TC58MT LOCATION 0265 FROM 5263 TO 4777.

CODE	DEFINITION	RESPONSE	LIMITS	PRESET
A	LOWEST DRIVE	N	0-7	0
B	HIGHEST DRIVE	N	0-7	0
C	TYPE OF DATA	0 FOR RANDOM 1 NNNN FOR CONSTANT	ANY DATA WORD	RANDOM
D	RECORD LENGTH	0 FOR RANDOM 1 NNNN FOR CONSTANT	0030-1000	RANDOM
E	FILE LENGTH	0 FOR RANDOM 1 NNNN FOR CONSTANT	0001-0200	RANDOM
F	BUFFER TO USE	0 FOR RANDOM 1 NNNN FOR CONSTANT	LEGAL DESIGNATOR	RANDOM

digital	FIELD SERVICE TECHNICAL MANUAL				Option or Designator
	12 Bit <input checked="" type="checkbox"/>	16 Bit <input type="checkbox"/>	18 Bit <input type="checkbox"/>	36 Bit <input type="checkbox"/>	DEC/X8

Title SYNOPSIS OF INFO ON DEC/X8 Software Modules			Tech Tip Number	DEC/X8-TT-2
All	Processor Applicability	Author	Don Herbener	Rev
		Approval	Frank Purcell	Date
				02/13/73
				Cross Reference

4.4 DEVICE SETUP

ALL DRIVES TO BE UTILIZED MUST BE ON LINE WITH TAPE POSITIONED AT OR AFTER BOT. THE WRITE PERMISS RING MUST BE IN PLACE.

4.5 RUNNING

1. CNTR: UPDATED AFTER A COMPLETE FILE HAS BEEN WRITTEN, READ-COMPARED, READ AND DATA CHECKED.
2. SR10: WHEN SET TO A 1, THE BUFFER CURRENTLY ASSIGNED IS RETAINED.
3. SR11: WHEN SET TO A 1, THE DRIVE CURRENTLY IN USE IS RETAINED.

5. ERROR INFORMATION

ALL STATUS REGISTER INDICATED ERRORS ARE REPORTED AS STATUS ERRORS, ALL DATA ERRORS AS DATA ERRORS.

5.1 ERROR SYMBOL DEFINITIONS

CODE:

0010 REWIND
0020 READ
0030 READ-COMPARE
0040 WRITE
0070 SPACE REVERSE

0021 FALSE DATA ERROR (BAD SOFTWARE CHECKSUM BUT DATA LOOKED GOOD ON WORD BY WORD CHECK).

00X3 TRANSFER INCOMPLETE (WORD COUNT NON-ZERO BUT NO ERROR BIT WAS SET).

SA: FINAL CONTENTS-OF STATUS REGISTER

SB: CURRENT BUFFER DESIGNATOR

SC: INITIAL WORD COUNT

SD: FINAL WORD COUNT

SE: INITIAL CURRENT ADDRESS

SF: FINAL CURRENT ADDRESS

SG: INITIAL COMMAND REGISTER

SH: FINAL COMMAND REGISTER

SI: RECORD TALLY (THE LAST RECORD IN A FILE IS 777. THIS WORD MAY BE USED TO COMPARE READ-COMPARE ERRORS WITH DATA ERRORS FOUND DURING READ.)

DA: BUFFER ADDRESS

DB: GOOD DATA WORD

DC: BAD DATA WORD

Title SYNOPSIS OF INFO ON DEC/X8 SOFTWARE MODULES (Cont.)						Tech Tip Number DEC/X8-TT-2				
All	Processor Applicability					Author	Don Herbener	Rev	0	Cross Reference
						Approval	Frank Purcell	Date	02/14/73	

1. TDBEDT MODULE DESCRIPTION

"TDBEDT" IS A DEC/X8 SOFTWARE MODULE WHICH EXERCISES A TDB-E DECTAPE SYSTEM WITH A ONE OR TWO UNIT TRANSPORT. THE MAIN CHARACTERISTICS OF THIS MODULE ARE:

1. ALL READ/WRITE TRANSFERS CONSIST OF 1000 (8) WORDS (4 DECTAPE BLOCKS) AND UTILIZE EXTERNAL BUFFERS.
2. SEARCH, READ, AND WRITE OPERATIONS ARE DONE WITH THE INTERRUPT TURNED OFF.
3. READ AND WRITE OPERATIONS ARE DONE IN THE FORWARD DIRECTION ONLY.
4. NORMALLY UNITS 0 AND 1 ARE EXERCISED RANDOMLY. FOR CONSTANT UNIT CAPABILITIES REFER TO UNIT SELECTION PARAGRAPH 4.3.1.
5. DATA IS NORMALLY RANDOM. FOR CONSTANT DATA CAPABILITIES REFER TO DATA PATTERN PARAGRAPH 4.3.2.
6. NORMALLY ALL BLOCKS FROM 0 TO 2701 ARE SEQUENTIALLY USED (0 TO 3, 1 TO 4, ...ETC., 2676 TO 2701). TO CHANGE LOW AND/OR HIGH BLOCK PARAMETERS REFER TO LOW AND HIGH BLOCK SELECTION PARAGRAPH 4.3.3.
7. THE OPERATIONS AT EACH BLOCK CONSIST OF WRITE/READ/CHECK DATA.
8. THREE READS ARE DONE IN CASE OF A PARITY ERROR.

2. REQUIREMENTS

1. PROCESSORS: PDP-8E, 8F, 8M
2. OPTIONS: TDB-E SIMPLE DECTAPE CONTROL WITH A TUSE WITH A ONE OR TWO DRIVE TRANSPORT.
3. SPECIAL: STANDARD PDP-8 FORMAT DECTAPES ARE RECOMMENDED (2702 BLOCKS, 201 WORDS EACH). NO GUARANTEE IS MADE FOR DECTAPES WITH ANY OTHER FORMAT.

3. RESTRICTIONS

SET THE UNIT SELECTS IN ACCORDANCE WITH THE NORMAL TDB-E PROCEDURES, AND USE THE APPROPRIATE DEVICE CODE WHEN BUILDING A SYSTEM.

WARNING

THE TDB-E SYSTEM IS DESIGNED TO OPERATE IN A STAND ALONE FASHION ONLY. TO INCLUDE THIS DEVICE IN THE DEC/X8 SET OF DEVICE MODULES, CERTAIN ACTIONS HAVE BEEN TAKEN WHICH MAY MINUTELY DEGRADE THE OVERALL EFFECTIVENESS OF INTERACTIVE EXERCISING OVER A GIVEN PERIOD OF TIME. THE USER SHOULD KEEP THE FOLLOWING POINTS IN MIND WHEN USING "TDBEDT"

- A. THE INTERRUPT IS TURNED OFF AND ALL OTHER DEVICE SERVICES ARE IGNORED WHENEVER THE TDB-E IS BEING SERVICED.

- B. AFTER A TDB-E SERVICE CYCLE IS COMPLETE, "TDBEDT" SETS A MONITOR SOFTWARE FLAG (IOFMSK) WHICH INDICATES TO ANY LATENT INTERRUPT DEVICE MODULES IN THE SYSTEM THAT LATENCY ERRORS MAY BE EXPECTED.

- C. BECAUSE OF THE ABOVE, "TDBEDT" CONTAINS A SERVICE DELAY COUNTER SO THE USER CAN REGULATE THE FREQUENCY AT WHICH THE TDB-E IS SERVICED. IF THE TDB-E IS SERVICED TOO FREQUENTLY, THE VALUE OF INTERACTIVE TESTING IS DIMINISHED. A RECOMMENDED DELAY BETWEEN SERVICE CYCLES IS 15 TO 30 SECONDS.

REFER TO PARAGRAPH 4.3.4 FOR INSTRUCTIONS RELATING TO SETTING THIS DELAY.

- D. PROBLEMS MAY BE ENCOUNTERED DUE TO TIMING CONSIDERATIONS IF A DEVICE SUCH AS THE FPP-12 OR VTB-E IS CONSTANTLY UTILIZING THE PROCESSOR DMA FUNCTION. IN THIS CASE A LARGE NUMBER OF TDB-E TIMING ERRORS MAY OCCUR. REFER TO PARAGRAPH 4.3.3 TO MASK SUCH ERRORS FROM REPORTING.

4. OPERATING INFORMATION

4.1 SPECIAL CONSIDERATIONS

THIS MODULE REQUIRES AND USES EXTERNAL BUFFERS.

4.2 BUILDING

1. JOB TYPE: BACKGROUND
2. PRIORITY: NON-CRITICAL
3. JOB SLOTS: JF1 OR JF2 ONLY; 4 PAGES REQUIRED.
4. STANDARD DEVICE CODE: 0770

4.3 INITIALIZING

THIS MODULE IS SETUP NORMALLY TO RUN A TDB-E DECTAPE SYSTEM WITH A DEVICE CODE OF 0770. THE DEVICE CODE IS SPECIFIED ONLY AT BUILDING TIME. UNIT SELECTION AND DATA ARE RANDOM. FOUR DECTAPE BLOCKS ARE SEQUENTIALLY EXERCISED FROM 0 TO 2701.

4.3.1 UNIT SELECTION

MAKE THE FOLLOWING CHANGES TO THE MODULE PROGRAM FOR THE DESIRED RESULTS.

MODULE LOCATION	RANDOM UNITS	UNIT 0	UNIT 1
0413	4773	7300	7330

digital	FIELD SERVICE TECHNICAL MANUAL				Option or Designator DEC/X8
	12 Bit <input checked="" type="checkbox"/>	16 Bit <input type="checkbox"/>	18 Bit <input type="checkbox"/>	36 Bit <input type="checkbox"/>	

Title SYNOPSIS OF INFO ON DEC/X8 SOFTWARE MODULES (Cont)			Tech Tip Number DEC/X8-TT-2		
All		Processor Applicability		Author Don Herbener	
				Rev 0	
		Approval Frank Purcell		Date 02/14/73	
Cross Reference					

4.3.2 DATA PATTERN

MAKE THE FOLLOWING CHANGES TO THE MODULE PROGRAM FOR THE DESIRED RESULTS.

MODULE LOCATION	RANDOM DATA	CONSTANT DATA	CONSTANT DATA PATTERN
0422	4773	1273	----
0515	4773	1273	----
0473	----	----	XXXX

4.3.3 LOW AND HIGH BLOCK SELECTION

- LOW BLOCK: DEPOSIT LOW BLOCK NUMBER (LIMITS: 0-2676) IN LOCATION 0463.
- HIGH BLOCK: DEPOSIT THE 1'S COMPLEMENT OF THE HIGH BLOCK NUMBER (LIMITS: 0-2676) IN LOCATION 0462.

IN ADDITION THE FOLLOWING MODULE LOCATION MAY BE CHANGED AS INDICATED TO ACHIEVE THE DESIRED RESULTS.

"REPORT"(0646) MAY BE CHANGED FROM 0300 TO 0X00 WHERE ANY CLEAR BITS IN STATUS 9 ARE NOT REPORTED AS ERRORS.

4.3.4 TDB-E SERVICE DELAY COUNTER

A SINGLE PRECISION COUNTER IS USED TO CONTROL THE DELAY BETWEEN TDB-E SERVICE CYCLES (REFER TO PARAGRAPH 3.). THE ACTUAL TIME OF THIS DELAY VARIES WITH THE COUNTER PRESET VALUE AND THE MIX OF JOBS RUNNING IN THE SYSTEM.

THE COUNTER PRESET IS INITIALLY SET TO 7777. TO CHANGE THIS VALUE USE ODT AND CHANGE MODULE LOCATION 0367 TO THE APPROPRIATE 2'S COMPLEMENT VALUE.

4.4 DEVICE SETUP

ALL UNITS TO BE EXERCISED MUST BE SWITCHED TO REMOTE AND WRITE ENABLED WITH TAPE IN PLACE. UNIT SELECTION MUST BE MADE IN ACCORDANCE WITH NORMAL TDB-E SETUP PROCEDURES.

4.5 RUNNING

- CNTR: UPDATED AFTER A SUCCESSFUL WRITE/READ COMPARE OPERATION.
- SR10: NO EFFECT
- SR11: NO EFFECT

5. ERROR INFORMATION

ALL COMMAND REGISTER ERRORS (SELECT, TIMING OR WRITE LOCKOUT) ARE REPORTED IN THE STANDARD STATUS ERROR FORMAT, DATA ERRORS IN THE DATA ERROR FORMAT.

5.1 ERROR SYMBOL DEFINITIONS

CODE:

0000 NO SIGNIFICANCE

0010 FALSE DATA ERROR (BAD SOFTWARE CHECKSUM BUT DATA LOOKED GOOD ON A WORD BY WORD CHECK). THIS TYPE OF ERROR MAY BE REPORTED AFTER A PARITY ERROR (BAD CHECKSUM ON TAPE) AND INDICATES THE FOLLOWING: 1) - THE PARITY ERROR CAUSED THE PROGRAM TO STOP TAPE PRIOR TO COMPLETION AND THEREBY CAUSED A SOFTWARE SUMCHECK ERROR; 2) - THE DATA THAT WAS TRANSFERRED WAS GOOD.

- SA: CONTENTS OF THE COMMAND REGISTER (LOADED)
 SB: CONTENTS OF THE COMMAND REGISTER (READ)
 SC: BLOCK NUMBER AT WHICH 4 BLOCK TRANSFER STARTS
 SD: BLOCK NUMBER CURRENTLY BEING PROCESSED
 SE: BLOCK NUMBER FOR CURRENT TAPE POSITION
 SF: BUFFER DESIGNATOR
 SG: INITIAL SOFTWARE WORD COUNT (ALWAYS - 1000)
 DA: BUFFER ADDRESS
 DB: GOOD DATA WORD
 DC: BAD DATA WORD

Title SYNOPSIS OF INFO ON DEC/X8 SOFTWARE MODULES (Cont)						Tech Tip Number	DEC/X8-TT-2			
All	Processor Applicability					Author	Don Herbener	Rev	0	Cross Reference
						Approval	Frank Purcell	Date	02/14/73	

1. TIMERA MODULE DESCRIPTION

"TIMERA" IS A DEC/X8 SOFTWARE MODULE WHICH CARRIES OUT THE FOLLOWING FUNCTIONS THROUGH THE USE OF A REAL TIME CLOCK.

1. REPORTS ELAPSED RUNTIME AT APPROXIMATELY 15 MINUTE INTERVALS (AFTER THE FIRST REPORT AT ELAPSED TIME 0 00 00).
2. REPORTS ANY INTERRUPT DRIVEN MODULE WHICH IS IN THE RUN STATE BUT WHOSE PASS COUNTER HAS NOT CHANGED WITHIN THE LAST 5 TO 10 MINUTES. A REPORT OF THIS TYPE INDICATES THAT THE SPECIFIED JOB IS MAKING NO PROGRESS, AND THAT PROBABLY THE DEVICE BEING EXERCISED BY THAT JOB FAILED TO GENERATE A PROGRAM INTERRUPT.
3. RANDOMIZE JOB SLOT ROTATION BY PERIODICALLY PLACING A RANDOM NUMBER IN THE DEC/X8 MONITOR LOCATION "ROTWRD" (00177). REFER TO THE "DEC/X8 USERS GUIDE", PARAGRAPH 4.3.3 FOR MORE INFORMATION ON "ROTWRD".
4. IF SO INITIALIZED, "TIMERA" WILL HALT THE EXERCISER AFTER "NN" HOURS OF ELAPSED RUNTIME, WHEN DEC/X8 TIMES OUT, "DEC/X8 TIMEOUT" WILL BE PRINTED AND THE EXERCISER WILL HALT.

THE ELAPSED TIME REPORT IS OF THE FORM:

TIMERA - JFX FLD N ET: D HH MM

WITH THE FOLLOWING DEFINITIONS:

"JFX" TIMERA MODULE JOB NUMBER
 "N" TIMERA CURRENT PROGRAM FIELD
 "D" ELAPSED TIME DAY NUMBER (0-6)
 "HH" ELAPSED TIME HOURS IN DECIMAL
 "MM" ELAPSED TIME MINUTES IN DECIMAL (00-59)

THE NO CHANGE IN JOB REPORT IS ALWAYS PRE-
 FACED BY AN ELAPSED TIME REPORT AND THEN:

CLOCKS /CLOCK PARAMETERS AND RESPONSES

	A	B	C
DKB-EA	100	0000	NNNN
DKB-EC	100	0000	NNNN
DKB-EP	011	0000	0062
KW12-A	021	0000	0062
KWB/I(8/L)			
----->A,B,C	130	0000	NNNN
----->D,E,F	132	NNNN	NNNN

D = No. OF HRS. TO RUN AND THEN HLT. APPLICABLE TO ALL CLOCKS.

*NO CHG JFX

WHERE "JFX" IS THE JOB NUMBER OF THE MODULE WHICH HAS INDICATED NO CHANGE IN ITS PASS COUNTER.

NOTE

ELAPSED TIME IS PRESET TO 0 00 00 WHEN TIMERA IS SWITCHED FROM THE KILLED TO THE RUN STATE.

2. REQUIREMENTS

1. PROCESSORS: PDP-8, 8/I, 8/L, 8/E, 8/M AND PDP-12
2. OPTIONS: REAL TIME CLOCKS TYPES: DKB-EA, -EC, -EP KWB/I(8/L)A, B, C, D, E, F KW12-A

3. SPECIAL: NONE

3. RESTRICTIONS

1. "TIMERA" DOES NOT RESPOND TO THE "KJFX" OR "AK" COMMANDS. IT MAY BE KILLED ONLY BY A RESTART AT 03000.
2. A MAXIMUM OF 4096 (DECIMAL) CLOCK TICKS PER SECOND ARE RECOGNIZED PROPERLY BY THE SOFTWARE.

4. OPERATING INFORMATION

4.1 SPECIAL CONSIDERATIONS

THIS MODULE REQUIRES EXTERNAL BUFFERS.

4.2 BUILDING

1. JOB TYPE: INTERRUPT DRIVEN
2. PRIORITY: SHOULD BE PLACED IMMEDIATELY AFTER ANY CRITICAL INTERRUPT MODULES.
3. JOB SLOTS: JF1 OR JF2 ONLY; 4 PAGES REQUIRED.
4. STANDARD DEVICE CODE: 0130

4.3 INITIALIZING

FAILURE TO INITIALIZE THIS MODULE WILL RESULT IN AN EXERCISER HANG.

digital	FIELD SERVICE TECHNICAL MANUAL				Option or Designator
	12 Bit <input checked="" type="checkbox"/>	16 Bit <input type="checkbox"/>	18 Bit <input type="checkbox"/>	36 Bit <input type="checkbox"/>	DEC/X8

Title SYNOPSIS OF INFO ON DEC/X8 SOFTWARE MODULES (Cont)					Tech Tip	
					Number DEC/X8-TT-2	
All	Processor Applicability			Author Don Herbener	Rev 0	Cross Reference
				Approval Frank Purcell Date 02/14/73		

INITIALIZE THE MODULE IN ACCORDANCE WITH THE TABLE BELOW. ALL INPUTS ARE ASSUMED TO BE POSITIVE OR ABSOLUTE OCTAL VALUES. IF THE INPUT FOR PARAMETER "B" IS GIVEN AS NNNN, SPECIFY THE CLOCK COUNTER BUFFER PRESET DESIRED. IF THE INPUT FOR PARAMETER "C" IS GIVEN AS NNNN, SPECIFY THE NUMBER OF CLOCK TICKS (INTERRUPTS) PER SECOND. IN THE CASE OF THE KW80 (B/L) D, E, AND F CLOCKS THE USER MUST COMPUTE THE PROPER VALUES FOR PARAMETERS "B" AND "C".

IF THE EXERCISER KILL OPTION IS DESIRED, RESPOND TO PARAMETER "D" BY TYPING "1 NN" WHERE "NN" DESIGNATES THE NUMBER OF HOURS THE EXERCISER IS TO BE RUN (00-27 IN OCTAL ARE VALID). IF THE KILL OPTION IS NOT DESIRED, TYPE "0".

4.4 DEVICE SETUP

NO SETUP IS REQUIRED UNLESS THE FREQUENCY SOURCE IS EXTERNAL TO THE CLOCK OPTION.

4.5 RUNNING

1. CNTR: UPDATED BY EVERY CLOCK TICK.
2. SR10: NO EFFECT
3. SR11: NO EFFECT

5. ERROR INFORMATION

THE ONLY CLOCK ERROR DETECTED BY TIMERA RESULTS IN A HALT AT RELATIVE LOCATION 1165. THIS HALT INDICATES THAT WHEN USING EITHER THE DK8EP OR KW12-A CLOCKS, THE OVERFLOW STATUS BIT WAS CLEAR BUT A CLOCK INTERRUPT OCCURRED. TO RECOVER, RESTART AT 03000.

Title SYNOPSIS OF INFO ON DEC/X8 SOFTWARE MODULES (Cont.)						Tech Tip Number	DEC/X8-TT-2			
All	Processor Applicability					Author	Don Herbener	Rev	0	Cross Reference
						Approval	Frank Purcell	Date	02/14/73	

1. TMBEMT MODULE DESCRIPTION

"TMBEMT" IS A DEC/X8 SOFTWARE MODULE WHICH EXERCISES A TM8E DECMAGTAPE SYSTEM WITH UP TO EIGHT TRANSPORTS. THE MAIN CHARACTERISTICS OF THIS MODULE ARE:

- RECORD LENGTH VARIES RANDOMLY FROM 30 TO 1000 WORDS OCTAL.
- FILE LENGTH VARIES RANDOMLY FROM 1 TO 200 RECORDS OCTAL. (EOF IS NOT WRITTEN.)
- THE TAPE OPERATIONS PERFORMED ARE WRITE/READ-COMPARE/READ FOR EACH "FILE". SPACE REVERSE IS USED TO MOVE FROM THE END TO THE BEGINNING OF THE FILE. REWIND IS USED ONLY WHEN EOT IS SENSED.
- ALL OPERATIONS ARE DONE AT 800 BPI, NORMAL GAP IN CORE DUMP MODE (9 TRACK TREATED AS 7 TRACK), GAP AND DENSITY MAY BE CHANGED BY THE USER AS INDICATED LATER; HOWEVER, NO PROVISIONS HAVE BEEN INCLUDED TO OPERATE IN STANDARD 9 TRACK COMPATIBLE MODE.
- ALL DRIVES WITHIN THE LIMITS OF THE LOWEST AND HIGHEST DRIVES SPECIFIED ARE RANDOMLY UTILIZED.
- UNLIKE MANY OTHER DECMAGTAPE EXERCISERS, THIS MODULE STARTS AT THE CURRENT TAPE POSITION. TAPE IS FORCED TO BOT ONLY WHEN EOT IS SENSED.
- ALL FUNCTIONS ARE ATTEMPTED IN A CONTINUOUS MODE OF OPERATION. THE CONDITION OF "TAPE UNIT READY" (TUR) IS NEVER SENSED BY THE SOFTWARE.

8. A "STAT ERR" WILL BE REPORTED WHEN ANY DRIVE REACHES EOT. THIS TYPE OF ERROR SHOULD BE CONSIDERED AN EXPECTED AND ACCEPTABLE EVENT PROVIDING THE ERROR "CODE" IS 4000 (WRITE FUNCTION BEING PERFORMED).

2. REQUIREMENTS

- PROCESSORS: PDP-8, 8/I, 8/L, 8/E, 8/M AND PDP-12.
- OPTIONS: TM8E DECMAGTAPE CONTROL WITH UP TO EIGHT 7 AND/OR 9 TRACK TRANSPORTS (TU10 OR EQUIVALENT).
- SPECIAL: INDUSTRY CERTIFIED STANDARD MAGNETIC TAPE.

3. RESTRICTIONS

9 TRACK COMPATIBLE MODE MAY NOT BE USED. ALL 9 TRACK TRANSPORTS WILL BE OPERATED IN CORE DUMP MODE.

4. OPERATING INFORMATION

4.1 SPECIAL CONSIDERATIONS

THIS MODULE REQUIRES EXTERNAL BUFFERS.

4.2 BUILDING

- JOB TYPE: INTERRUPT DRIVEN
- PRIORITY: NON-CRITICAL.
- JOB SLOTS: JF1 OR JF2 ONLY; 4 PAGES REQUIRED.
- STANDARD DEVICE CODES: 0700, 0710, 0720

4.3 INITIALIZING

AFTER THE INDICATED CODE LETTER IS PRINTED RESPOND BY TYPING THE PARAMETER IN THE MANNER SHOWN BELOW.

CODE	DEFINITION	RESPONSE	LIMITS	PRESET
A	LOWEST DRIVE	N	0-7	0
B	HIGHEST DRIVE	N	0-7	0
C	TYPE OF DATA	0 FOR RANDOM 1 NNNN FOR CONSTANT	ANY DATA WORD	RANDOM
D	RECORD LENGTH	0 FOR RANDOM 1 NNNN FOR CONSTANT	0038-1000	RANDOM
E	FILE LENGTH	0 FOR RANDOM 1 NNNN FOR CONSTANT	0001-0200	RANDOM
F	BUFFER TO USE	0 FOR RANDOM 1 NNNN FOR CONSTANT	LEGAL DESIGNATOR	RANDOM

	FIELD SERVICE TECHNICAL MANUAL				Option or Designator DEC/X8
	12 Bit <input checked="" type="checkbox"/>	16 Bit <input type="checkbox"/>	18 Bit <input type="checkbox"/>	36 Bit <input type="checkbox"/>	

Title SYNOPSIS OF INFO ON DEC/X8 SOFTWARE MODULES (Cont.)				Tech Tip Number	DEC/X8-TT-2
All	Processor Applicability	Author Don Herbener	Rev 0	Cross Reference	
		Approval Frank Purcell	Date 02/14/73		

IN ADDITION BITS 10 AND 11 OF LOCATION KCMD (0713) MAY BE CHANGED TO A LEGAL DENSITY SELECTION EXCEPT 9-TRACK COMPATIBLE 800 BPI. ALSO BIT 3 OF LOCATION KFUNC (0330) MAY BE CHANGED TO ALTER INTERRECORD GAP. BIT ASSIGNMENTS FOR BOTH OF THESE WORDS ARE THE SAME AS FOR THE TM8E COMMAND AND FUNCTION REGISTERS RESPECTIVELY. ANY BITS IN LOCATION REPORT (1035) MAY BE ZEROED TO INHIBIT REPORTING PARTICULAR TYPES OF ERRORS. BIT ASSIGNMENT IN THIS WORD IS THE SAME AS IN THE MAIN STATUS REGISTER.

4.4 DEVICE SETUP

ALL DRIVES TO BE UTILIZED MUST BE ON LINE WITH TAPE POSITIONED AT OR AFTER BOT. THE WRITE PERMISS RING MUST BE IN PLACE.

4.5 RUNNING

1. CNTR: UPDATED AFTER A COMPLETE FILE HAS BEEN WRITTEN, READ-COMPARED, READ AND DATA CHECKED.
2. SR10: WHEN SET TO A 1, THE BUFFER CURRENTLY ASSIGNED IS RETAINED.
3. SR11: WHEN SET TO A 1, THE DRIVE CURRENTLY IN USE IS RETAINED.

5. ERROR INFORMATION

ALL STATUS REGISTER INDICATED ERRORS ARE REPORTED AS STATUS ERRORS. ALL DATA ERRORS AS DATA ERRORS.

5.1 ERROR SYMBOL DEFINITIONS

CODE:

1000 REWIND
2000 READ
3000 READ-COMPARE
4000 WRITE
7000 SPACE REVERSE

2001 FALSE DATA ERROR (BAD SOFTWARE CHECKSUM BUT DATA LOOKED GOOD OR WORD BY WORD CHECK).

X003 TRANSFER INCOMPLETE (WORD COUNT NON-ZERO BUT NO ERROR BIT WAS SET).

SA: FINAL CONTENTS OF MAIN STATUS REGISTER

SB: CURRENT BUFFER DESIGNATOR

SC: INITIAL WORD COUNT

SD: FINAL WORD COUNT

SE: INITIAL CURRENT ADDRESS

SF: FINAL CURRENT ADDRESS

SG: INITIAL COMMAND REGISTER

SH: FINAL COMMAND REGISTER

SI: INITIAL FUNCTION REGISTER

SJ: FINAL FUNCTION/STATUS REGISTER

SK: FINAL DATA BUFFER (LPCC AFTER A READ OR READ-COMPARE)

SL: RECORD TALLY (THE LAST RECORD IN A FILE IS 7777. THIS WORD MAY BE USED TO COMPARE READ-COMPARE ERRORS WITH DATA ERRORS FOUND DURING READ.)

DA: BUFFER ADDRESS

DB: GOOD DATA WORD

DC: BAD DATA WORD

Title SYNOPSIS OF INFO ON DEC/X8 SOFTWARE MODULES (Cont)						Tech Tip Number	DEC/X8-TT-2			
All	Processor Applicability					Author	Don Herbener	Rev	0	Cross Reference
						Approval	Frank Purcell	Date	02/14/73	

1. VCADBE MODULE DESCRIPTION

"VCADBE" IS A DEC/X8 SOFTWARE MODULE WHICH EXERCISES THE VCBE DISPLAY CONTROL WITH VR14 OR VR20 DISPLAY AND THE ADBEA ADC WITH AMBEA MULTIPLEXOR AND AMBEC PANEL.

THE MODULE SAMPLES 4 ANALOG CHANNELS (0-3) AND DISPLAYS THE RESULTS ON THE SCREEN IN THE FORM OF A CROSS. THE SAMPLED DATA CONTROLS THE CROSS AS FOLLOWS:

CHANNEL 0	X VALUE OF CENTER OF CROSS
CHANNEL 1	Y VALUE OF CENTER OF CROSS
CHANNEL 2	LENGTH OF HORIZONTAL LINE SEGMENT
CHANNEL 3	LENGTH OF VERTICAL LINE SEGMENT

POINTS ARE INTENSIFIED ON THE SCREEN IN THE FOLLOWING MANNER WITH EVERY FOURTH POSSIBLE POINT BEING INTENSIFIED:

```

.
.
.
.(11)
.(7)
.(3)
.(2),(6),(10)...          ....(9),(5),(1)
.
.(4)
.(8)
.(12)
.
.

```

THIS CONTINUES UNTIL ONE AXIS HAS INTENSIFIED ALL POINTS THEN COMPLETES THE UNFINISHED AXIS.

WHEN THE POSITION AND LENGTH FOR A LINE IS SUCH THAT THE SCREEN BOUNDARY IS PENETRATED, THE REMAINING POINTS WRAP AROUND TO THE OPPOSITE SIDE OF THE SCREEN. IF THE LINE LENGTH IS A MAXIMUM WHEN WRAP AROUND OCCURS THE WRAP AROUND LINE LACKS ONE DOT REACHING THE OTHER END OF THE LINE.

IN THE ABSENCE OF A ADBEA/AMBEA/AMBEC, CHANNELS 0 AND 1 ARE ASSUMED TO BE 0000 WHILE CHANNELS 2 AND 3 ARE 7777. THIS PRODUCES A FULL SCALE CROSS IN THE CENTER OF THE SCREEN.

WHEN A COLOR DISPLAY (VR20) IS USED THE FIRST HALF OF THE TOTAL NUMBER OF DOTS ON THE SCREEN WILL BE DISPLAYED IN RED AND THE SECOND HALF IN GREEN. ALSO THOSE DISPLAYED IN GREEN WILL BE ON DISPLAY CHANNEL 1 WHILE THOSE IN RED ARE ON DISPLAY CHANNEL 2.

2. REQUIREMENTS

1. PROCESSOR: PDP-8/E, 8/M, 8/F
2. OPTIONS: VCBE WITH VR14 OR VR20
ADBEA WITH AMBEA AND AMBEC
3. SPECIAL: NONE

3. RESTRICTIONS

NONE

4. OPERATION INFORMATION

4.1 SPECIAL CONSIDERATIONS

NONE

4.2 BUILDING

1. JOB TYPE: BACKGROUND
2. PRIORITY: MUST HAVE LOWER PRIORITY THAN ALL INTERRUPT JOBS.
3. JOB SLOTS: ANY EXISTENT JOB SLOT: 2 PAGES REQUIRED.
4. STANDARD DEVICE CODES:
0050 FOR VCBE
0530 FOR ADBEA/AMBEA

4.3 INITIALIZING

THE MODULE MAY BE INITIALIZED TO RUN WITH OR WITHOUT AN ADC AND WITH A VR14 OR VR20. AFTER THE INDICATED CODE LETTER IS PRINTED RESPOND BY TYPING THE PARAMETER IN THE MANNER SHOWN BELOW.

CODE	DEFINITION	RESPONSE	PRESET
A	IS ADBEA/AMBEA PRESENT	0 = VCBE ONLY 1 = VCBE WITH ADBEA/AMBEA	1
B	TYPE OF DISPLAY	0 = VR14 6 = VR20	0

4.4 DEVICE SETUP

THE VR14 OR VR20 SHOULD BE POWERED UP AND SHOULD HAVE "CHANNEL 1 & 2" AND "REMOTE" SELECTED ON THE FRONT PANEL.

4.5 RUNNING

1. CNTR: UPDATED UPON EACH "CROSS" COMPLETION.
2. SR10: NO EFFECT
3. SR11: NO EFFECT

5. ERROR INFORMATION

THE ONLY ERROR POSSIBLE IS IF THE VCBE OR ADBEA IS GIVEN AN INSTRUCTION AND FAILS TO COME BACK WITH A DONE FLAG. IN SUCH INSTANCES A SOFTWARE TIMER DETERMINES THAT THE RESPECT-RED DEVICE IS IN A "HANG" STATE AND EXITS TO THE ERROR ROUTINE. ERROR CODE 0000 INDICATES AN AD HANG WHILE 7777 INDICATES A VC HANG. "ERRSA" IS MEANINGLESS FOR VC HANG BUT INDICATES THE AM CHANNEL + 1 IN USE IF AN AD HANG.

DIGITAL EQUIPMENT CORPORATION

digital	FIELD SERVICE TECHNICAL MANUAL				Option or Designator
	12 Bit <input checked="" type="checkbox"/>	16 Bit <input type="checkbox"/>	18 Bit <input type="checkbox"/>	36 Bit <input type="checkbox"/>	DEC/X8

Title SYNOPSIS OF INFORMATION ON DEC/X8 SOFTWARE MODULES			Tech Tip Number	DEC/X8-TT-2
All	Processor Applicability	Author Don Herbener	Rev 0	Cross Reference
1. VT8E MODULE DESCRIPTION		Approval Frank Purcell	Date 02/14/73	

"VT8E" IS A DEC/X8 SOFTWARE MODULE WHICH EXERCISES A VT8-E DECDISPLAY IN BOTH ALPHA AND GRAPHIC MODES OF OPERATION. IT ALSO UTILIZES THE VT8-E LINE FREQUENCY CLOCK FOR VARIOUS TIME CHECK PURPOSES. THE KEYBOARD AND PRINTER FUNCTIONS WHICH ARE PART OF THE VT8-E ARE NOT EXERCISED BY THIS MODULE.

1.1 VT8-E DISPLAY EXERCISING

"VT8E" UTILIZES THE ALPHA AND GRAPHIC CAPABILITIES IN FOUR UNIQUE SOFTWARE MODES. ANYONE OF WHICH MAY BE CHOSEN BY THE USER. REFER TO PARAGRAPH 4.3 FOR INITIALIZING INFORMATION.

THE FOLLOWING SUBPARAGRAPHS LIST THE CHARACTERISTICS OF EACH OF THESE MODES.

1. "ALPHA ONLY" MODE

- A. UTILIZES THE VT8-E ALPHA MODE ONLY.
- B. DISPLAYS 447 (10) CHARACTERS WHICH IS EQUIVALENT TO 7 LINES @ 64 CHARACTERS PER LINE, OR 14 LINES @ 32 CHARACTERS PER LINE, IN BOTH CASES THE LAST CHARACTER IN THE LAST LINE (7TH OR 14TH) IS END OF SCREEN (EOS).
- C. ALL CHARACTERS BEING DISPLAYED AT A GIVEN TIME HAVE THE SAME ASCII CODE. HOWEVER, STARTING WITH THE FIRST CHARACTER EACH GROUP OF FOUR CHARACTERS APPEARS AS FOLLOWS:

X(NORMAL INTENSITY) X(BLINK) X(BRIGHT) X(CURSORS)

THIS SEQUENCE IS REPEATED THROUGH ALL 447 CHARACTERS.

- D. EACH DISPLAY PERIOD LASTS FOR APPROXIMATELY FIVE SECONDS, THEN THE ASCII CODE OF THE CHARACTER IS INCREMENTED BY ONE, THE RANGE OF CHARACTERS DISPLAYED IS FROM 040 TO 137 (SEVEN BIT ASCII).
- E. THE FIRST CHARACTER TO BE USED AT RUN TIME DEPENDS ON THE PRIOR STATE OF THE SOFTWARE MODULE.

2. "GRAPHIC ONLY" MODE

- A. UTILIZES THE VT8-E GRAPHIC MODE ONLY.
- B. DISPLAYS 28 LINES @ 16 WORDS PER LINE OF PLANNED DATA. THE REMAINDER OF THE DISPLAY CONTAINS RANDOM DATA WHICH LIES OUTSIDE OF THE CURRENT BUFFER AREA. NOTE THAT THE 3 LEAST SIGNIFICANT BITS OF THE LAST WORD ON EACH LINE ARE NEVER DISPLAYED, ALSO THE LAST WORD ON THE 28TH LINE IS ALWAYS 3000.

EACH WORD OF PLANNED DATA DISPLAYED IS IDENTICAL. THIS PLANNED DATA CHANGES ABOUT ONCE EVERY FIVE SECONDS AND PROGRESSES THROUGH THE FOLLOWING OCTAL SEQUENCE:

0001, 0003, 0007, 0017, 0037, 0077, 0177, 0377, 0777, 1777, 3777, 7777, ETC.

- D. THE FIRST DATA PATTERN TO BE USED AT RUN TIME DEPENDS ON THE PRIOR STATE OF THE SOFTWARE MODULE.

3. "ALPHA/GRAPHIC" MODE

- A. UTILIZES BOTH THE ALPHA AND GRAPHIC MODES OF THE VT8-E.
- B. MAKES ONE PASS OF ALL CHARACTERS IN THE "ALPHA ONLY" MODE (1.1.1), THEN ONE PASS OF DATA IN THE "GRAPHIC ONLY" MODE (1.1.2), THEN SWITCHES BACK TO "ALPHA ONLY".
- C. THE FIRST MODE AND CHARACTER OR DATA USED AT RUN TIME DEPENDS ON THE PRIOR STATE OF THE SOFTWARE MODULE.

4. "SPECIAL GRAPHIC" MODE

- A. UTILIZES THE VT8-E GRAPHIC MODE ONLY.
- B. DISPLAYS ANY AREA OF MEMORY AS SPECIFIED BY THE USER (REFER TO CHANGES TO "ABSADD" AND "ABSFLD" IN PARAGRAPH 4.3).

NOTE

THIS MODE MAY PROVE TO BE A VERY INTERESTING EXPERIENCE FOR THE USER.

1.2 USAGE OF THE VT8-E LINE FREQUENCY CLOCK

THE FOLLOWING FUNCTIONS ARE CARRIED OUT THROUGH THE USE OF THE VT8-E CLOCK.

- 1. REPORTS ELAPSED RUNTIME AT APPROXIMATELY 15 MINUTE INTERVALS (AFTER THE FIRST REPORT AT ELAPSED TIME 0 00 00, THIS FUNCTION MAY BE DELETED (REF. PARAGRAPH 4.3)).
- 2. REPORTS ANY INTERRUPT DRIVEN MODULE WHICH IS IN THE RUN STATE BUT WHOSE PASS COUNTER HAS NOT CHANGED WITHIN THE LAST 5 TO 10 MINUTES, A REPORT OF THIS TYPE INDICATES THAT THE SPECIFIED JOB IS MAKING NO PROGRESS, AND THAT PROBABLY THE DEVICE BEING EXERCISED BY THAT JOB FAILED TO GENERATE A PROGRAM INTERRUPT, THIS FUNCTION MAY BE DELETED (REF. PARAGRAPH 4.3).
- 3. RANDOMIZE JOB SLOT ROTATION BY PERIODICALLY PLACING A RANDOM NUMBER IN THE DEC/X8 MONITOR LOCATION "ROTWRD" (00177). REFER TO THE "DEC/X8 USERS GUIDE", PARAGRAPH 4.3.3 FOR MORE INFORMATION ON "ROTWRD".

Title SYNOPSIS OF INFO ON DEC/X8 SOFTWARE MODULES (Cont)					Tech Tip Number	DEC/X8-TT-2	
All	Processor Applicability				Author Don Herbener	Rev 0	Cross Reference
					Approval Frank Purcell	Date 02/14/73	

4. IF SO INITIALIZED, "VTBE" WILL HALT THE EXERCISER AFTER 1 TO 23 HOURS OF ELAPSED RUNTIME. THE HALT LOCATION IS MODULE RELATIVE 0720.

THE ELAPSED TIME REPORT IS OF THE FORM:

VTBE-JFX FLD N ET: D HH MM

WITH THE FOLLOWING DEFINITIONS:

"JFX" VTBE MODULE JOB NUMBER

"N" VTBE CURRENT PROGRAM FIELD

"D" ELAPSED TIME DAY NUMBER (0-6)

"HH" ELAPSED TIME HOURS IN DECIMAL (00-23)

"MM" ELAPSED TIME MINUTES IN DECIMAL (00-59)

THE NO CHANGE IN JOB REPORT IS ALWAYS PRECEDED BY AN ELAPSED TIME REPORT AND THEN:

*NO CHG JFX

WHERE "JFX" IS THE JOB NUMBER OF THE MODULE WHICH HAS INDICATED NO CHANGE IN ITS PASS COUNTER.

NOTE
ELAPSED TIME IS PRESET TO 0 00 00
WHEN VTBE IS SWITCHED FROM THE
KILLED TO THE RUN STATE.

2. REQUIREMENTS

1. PROCESSORS: PDP-8/E, 8/F, 8/M
2. OPTIONS: VT8-E DECDISPLAY WITH VIDEO MONITOR
3. SPECIAL: NONE

3. RESTRICTIONS

THE KEYBOARD AND PRINTER FUNCTIONS OF THE VT8-E ARE NOT EXERCISED BY THIS MODULE, AND INTERRUPTS FROM THESE DEVICES MAY RESULT IN AN UNACKNOWLEDGED INTERRUPT MONITOR HALT.

4. OPERATING INFORMATION

4.1 SPECIAL CONSIDERATIONS

THIS MODULE REQUIRES EXTERNAL BUFFERS.

4.2 BUILDING

1. JOB TYPE: INTERRUPT DRIVEN
2. PRIORITY: SHOULD BE PLACED IMMEDIATELY AFTER ANY CRITICAL INTERRUPT MODULES.
3. JOB SLOTS: JF1 OR JF2 ONLY; 4 PAGES REQUIRED.
4. STANDARD DEVICE CODE: 0050

4.3 INITIALIZING

USING THE !JFX -] COMMAND, AFTER "VTBE" IS PRINTED RESPOND BY TYPING THE DESIRED CODE NUMBER TO SELECT THE DESIRED DISPLAY SOFTWARE MODE.

CODE	DISPLAY SOFTWARE MODE	REFERENCE
0	ALPHA/GRAPHIC	1.1.3 (PRESET VALUE)
1	ALPHA ONLY	1.1.1
2	GRAPHIC ONLY	1.1.2
3	SPECIAL GRAPHIC	1.1.4

IN ADDITION THE FOLLOWING LOCATIONS MAY BE CHANGED VIA I O AS INDICATED.

1. "PRETIC" (0317): 2'S COMPLEMENT OF THE NUMBER OF CLOCK TICKS PER SECOND. PRESET FOR 60(10) TICKS PER SECOND.
2. "TIMOUT" (0754): 1'S COMPLEMENT OF THE NUMBER OF HOURS (UP TO 23) OF EXERCISER RUNTIME DESIRED. PLACING 0000 IN THIS LOCATION RESULTS IN THE EXERCISER RUNNING FOREVER. PRESET TO RUN FOREVER.
3. "ABSADD" (1154): THE ABSOLUTE STARTING ADDRESS FOR "SPECIAL GRAPHIC" MODE. PRESET TO 0000.
4. "ABSFLD" (1155): THE STARTING MEMORY FIELD (BITS 6-8) FOR "SPECIAL GRAPHIC" MODE. PRESET TO 0000.
5. "MAXCAR" (1156): THE 1'S COMPLEMENT OF THE 7 BIT ASCII FOR THE MAXIMUM DISPLAYABLE CHARACTER IN ALPHA MODE. PRESET FOR MAXIMUM OF CODE 137.
6. "BUFLN" (1157): THE 2'S COMPLEMENT OF THE NUMBER OF CHARACTER SLOTS TO BE DISPLAYED IN ALPHA MODE. THE RANGE IS FROM -1 THROUGH -677. PRESET TO -677 FOR 447(10) CHARACTERS PLUS EOS. THE VALUE IN THIS LOCATION CONTROLS THE AMOUNT OF DMA LOAD CAUSED BY THE VT8-E IN ALPHA MODE. THE ONLY EFFECT IN GRAPHIC MODE IS TO CHANGE THE NUMBER OF PLANNED DATA WORDS.
7. TO DELETE THE ELAPSED TIME REPORTING FUNCTION, CHANGE THE CONTENTS OF LOCATION "TIMEA" (0613) FROM 1141 TO 5217.
8. TO DELETE THE JOB DEAD CHECKING AND JOB DEAD REPORTING FUNCTION, CHANGE THE CONTENTS OF LOCATION "TIMEB" (0443) FROM 4773 TO 5252.

4.4 DEVICE SETUP

NONE REQUIRED OTHER THAN NORMAL ONLINE SETUP.

DIGITAL EQUIPMENT CORPORATION

digital	FIELD SERVICE TECHNICAL MANUAL				Option or Designator
	12 Bit <input checked="" type="checkbox"/>	16 Bit <input type="checkbox"/>	18 Bit <input type="checkbox"/>	36 Bit <input type="checkbox"/>	DEC/X8

Title SYNOPSIS OF INFO ON DEC/X8 SOFTWARE MODULES (Cont)					Tech Tip Number	DEC/X8-TT-2
All	Processor Applicability			Author Don Herbener	Rev 0	Cross Reference
				Approval Frank Purcell	Date 02/14/73	

4.5 RUNNING

1. CNTR: UPDATED ONCE PER MINUTE
2. SR10: NO EFFECT
3. SR11: NO EFFECT

5. ERROR INFORMATION

ALL ERROR DETECTION IS VISUAL.

NOTE THAT A HALT AT MODULE LOCATION 0720 INDICATES THAT DEC/X8 HAS TIMED OUT. THIS HALT SHOULD OCCUR IMMEDIATELY AFTER THE FIRST ELAPSED TIME REPORT AT NN HOURS WHERE "NN" IS THE TIME OUT VALUE.

5.1 HELPFUL HINTS

UNFORTUNATELY THERE IS NO PROVISION FOR SELECTING A CONSTANT BUFFER OR AUTOMATI-

CALLY FREEZING THE CURRENT BUFFER SELECTION. HOWEVER, IF A DISPLAY FAILURE DOES OCCUR, OR DOES CAUSE ANOTHER DEVICE TO FAIL, IMMEDIATELY COMMAND 'C' AND USING 'O' CHANGE THE FOLLOWING MODULE LOCATIONS.

MODULE LOCATION	FROM	TO
0610	4775	7000
0617	6002	5223

THESE CHANGES WILL FREEZE THE CURRENT BUFFER ASSIGNMENT AS LONG AS THE MODULE REMAINS IN THE RUN STATE.

IT IS IMPERATIVE THAT THESE LOCATIONS BE RESTORED TO THEIR ORIGINAL CONTENTS PRIOR TO SWITCHING FROM THE KILLED TO THE RUN STATE.

Title ORDERING DEC/X8 FROM THE PROGRAM LIBRARY						Tech Tip Number DEC/X8-TT-3			
All		Processor Applicability		Author Don Herbener		Rev 0		Cross Reference	
8's				Approval F. Purcell		Date 04/11/73			

There seems to be some confusion in ordering DEC/X8 from the Program Library. I suggest field representatives do not order "personal" copies from the Program Library but instead order LibKit-X8-D1QAA and specify tapes only, and use DEC/X8 Tech Tip-2 for the module information. Revision B of the monitor and all software modules are currently being mailed to the field offices for reference. Below is a list of the Libkit numbers and some DEC/X8 maindec numbers:

Papertape and Documents	LIBKIT-X8-D1QAA
DECTAPE and Documents	LIBKIT-X8-D1QBA
Linctape and Documents	LIBKIT-X8-D1QCA
Users Guide Only	MAINDEC-X8-D1QAB
File DECTape Only	MAINDEC-X8-D1QAE
File Linctape Only	MAINDEC-X8-DDQAA

COMPANY CONFIDENTIAL

digital	FIELD SERVICE TECHNICAL MANUAL				Option or Designator
	12 Bit <input checked="" type="checkbox"/>	16 Bit <input type="checkbox"/>	18 Bit <input type="checkbox"/>	36 Bit <input type="checkbox"/>	DF32

Title DF32, DF32D FALSE FALCOM ERRORS				Tech Tip Number DF32-TT-1		
All	Processor Applicability			Author W. Kochman	Rev 0	Cross Reference
	8L			Approval W. Cummins	Date 07/31/72	

Falcom errors with an 8L and a DF32 or DF32D system may occur on 60 cycle systems due to the DF32, DF32D Disk Data Maindec DFLE or later revisions. This is due to the time constant normally changed for 50 cycle operation being too small. Location 1772 should be changed from 6 to approximately 15 to ensure proper timing for falcom compare.

Title DF32 WRITE LOCK PROBLEMS				Tech Tip Number DF32-TT-2		
All 8's	Processor Applicability			Author Toolan/Kochman	Rev 0	Cross Reference
				Approval W. Cummins	Date 07/31/72	

Problem 1

Very intermittent data failures especially in environments with poor electrical noise. Print D-BS-DF32-0-5. Assume the write lock switches are in the open position. We then have fairly long open circuit lines to A6T and A6E, which pick up spikes and if they are sufficiently bad cause data errors.

Fix 1 I don't know of any spare clamped loads, so I use a 15 K resistor to -15V giving a 1mA current source, via termi-points on the wiring side.

Problem 2

Same print. Assume that fix 1 is not implemented. Assume write lock switch is closed. Problem is that write lock sometimes fails to lock out depending on resistor tolerance. Reason is that the midair upside down "and" gate of +10 V and 4.7 K gives approximately 2mA of write lock current, the G285 takes 1mA and the R002/R111 (on the skip logic) another 1mA. Result is that depending on resistor tolerance the WIA and WTB signals can be at an indeterminate level of say minus 1.5 volts. This can cause intermittent failures of write lock and information can be lost.

Fix 2 Which also takes into account the extra current requirement of fix 1, is to replace the 4.7 K resistors on the rear of the rotary switch by 2.2 K.

COMPANY CONFIDENTIAL

Title						DF32 - DS32 DISK DATA ERRORS		Tech Tip Number		DF32-TT- 3	
All		Processor Applicability				Author G. Chaisson		Rev 0		Cross Reference	
		Approval W. Cummins				Date 07/31/72					

PROBLEM: Disk data errors will occur while running customer programs and no disk errors will occur when running disk diagnostics for extended periods of time. (Disk data diagnostic runs twenty passes OK.)

POSSIBLE

SOLUTION: It has been found that the above symptoms have occurred when the TTA and TTB timing tracks have just been on the edge of being marginal. In some cases, looking at the timing tracks with a scope will show either a high or low output amplitude or an uneven output.

In the first case where the amplitude is incorrect, adjustment of the read amplifier is indicated. In the second case where the uneven output is observed, it is a good idea to switch to the spare timing tracks.

Title						DF32 HARDWARE INDICATORS OF NON-EXISTENT DISK SELECTION		Tech Tip Number		DF32-TT-4	
All		Processor Applicability				Author W. Kochman		Rev 0		Cross Reference	
		Approval W. Cummins				Date 07/31/72					

- 1) NEX status bit will be set whenever attempting any selection of a non-existent disk. The programmer must differentiate whether or not write lock is also causing this status bit to be set.
- 2) NED FF will be set only if a transfer spirals onto a non-existent disk. It is normally set after reading the last word of the last track of existent disks on the last word of a transfer, and under this circumstance alone is designed to set TRC. NED generates an interrupt.

digital	FIELD SERVICE TECHNICAL MANUAL				Option or Designator DF32
	12 Bit <input checked="" type="checkbox"/>	16 Bit <input type="checkbox"/>	18 Bit <input type="checkbox"/>	36 Bit <input type="checkbox"/>	

Title DF32 INSTRUCTION MANUAL ERROR				Tech Tip Number DF32-TT-5	
All	Processor Applicability	Author Bill Freeman	Rev 0	Cross Reference	
X		Approval W. Cummins	Date 07/31/72		

"Disk Operating Procedure for Timing Track Writer, DF32", Page 5-7, Instructions 15, 16 and 17 are in error and should read:

- (15) Change the scope to alternate sweep and plug probe B into banana jack 9. This test point is the write disable delay which is initiated at the beginning of the photocell signal and terminates at the center of the photocell signal.
- (16) The adjustment associated with Jack 9 is P3, located beside the jack. With a screwdriver, adjust this delay time to 100 usec. and observe, on the scope, the two traces of the photocell signal and the delay together. If the signal from Jack 9 appears to initiate at the end of the photocell signal, the photocell switch is in the wrong position.
- (17) After adjusting the P3 delay, and without changing the scope settings, remove probe B from Jack 9 and plug it into Jack 8. This output is the writer track enable delay and is initiated at the beginning of the photocell signal. The delay associated with this delay is P2.

Title OHM METER TESTING OF DISK HEADS IN RF/RS08-DF32				Tech Tip Number DF32-TT- 6	
All	Processor Applicability	Author W. Freeman	Rev 0	Cross Reference	
X		Approval W. Cummins	Date 07/31/72		

It is advisable to have a track writer available before undertaking ohm meter testing for defects in a disk head or cable. The current which can be produced through a disk head by an ohm meter is sufficient to cause an alteration of data on the disk. Even if the disk is not rotating, a glitch may be produced on the disk directly beneath the head.

Title DF32 TROUBLESHOOTING						Tech Tip Number DF32-TT-7	
All		Processor Applicability		Author D. Herbener		Rev 0	
				Approval W. Cummins		Date 07/31/72	
Cross Reference							

There has been a problem in the field with men working on DF32 disks and not having readily available to them a scope loop for checking the G285 and G286 matrix selectors, and often not having the G702 light card for use with Diskless. It is possible for two tracks to be selected at all times and for Diskless to run. Disk Data will run and may indicate intermittent parity errors, random select errors, or a failure at one particular address; Multi Disk may also run. Disk Data and Multi Disk will run because they both write one track and then read the same track. Many times the failure is obscured and may lead a field service engineer astray.

The following program has two important features: First, it will monitor the switch register and select a track; by using an oscilloscope the selectors can be checked to see that only one track is selected at any time. Second, the G284 disk writer can be monitored with a scope and the play back voltage can be checked to see if one track is weaker than the others, or if any track has irregularities in voltage.

The switch register bit assignments for disk and track selection are as follows:

Bit 0 will select track 0 or 1
 Bit 5 will select track 2
 Bit 4 will select track 4
 Bit 3 will select track 10

Bits 1 and 2 will select disks 0 thru 3

Bits 6 thru 8 will select which memory field will be involved in the data transfer.

By varying the constants (AMT) and (ADR) the program can be used to transfer any quantity of data to any area of core. Also, if the instruction DMAR (6603) is changed to DMAW (6605), the program will write on the disk rather than read from it.

To start the program, load address 7400, set the switch register to 0000, and start.

	DCEA=6611	7414	7200	CLA
	DCMA=6601	7415	1235	TAD SW
	DEAL=6615	7416	7510	SPA
	DFSC=6622	7417	5224	JMP .+5
	DMAW=6605	7420	7200	CLA
	DMAR=6603	7421	6603	DMAR
	PAUSE	7422	5226	JMP WAIT
	*7400	7423	1234	TAD K4000
		7424	6603	DMAR
7400	7300	7425	5226	JMP WAIT
7401	6601	7426	6622	WAIT, DFSC
7402	6611	7427	5226	JMP .-1
7403	1237	7430	5200	JMP BEG
7404	3631	7431	7750	WC, 7750
7405	1236	7432	7751	CA, 7751
7406	3632	7433	3770	K3770, 3770
7407	7604	7434	4000	K4000, 4000
7410	3235	7435	0000	SW, 0000
7411	1235	7436	7577	ADR, 7577
7412	0233	7437	7777	AMT, 7777
7413	6615			

digital	FIELD SERVICE TECHNICAL MANUAL				Option or Designator DF32-TT-8
	12 Bit <input checked="" type="checkbox"/>	16 Bit <input type="checkbox"/>	18 Bit <input type="checkbox"/>	36 Bit <input type="checkbox"/>	

Title DF32 DISK ON LINC-8				Tech Tip Number DF32-TT-8	
All Processor Applicability		Author D. Crowther	Rev 0	Cross Reference	
X		Approval H. Long	Date 09/14/72		

Hardware needed to add a cab onto a LINC-8/

All trim should be black
 3 - Center clips #74-5354
 1 - Cab top spacer #74-5343
 2 - Fillers #74-5347
 3 - Flat clips #74-5344
 24 - 10-32-5/8" screws
 24 - #10 External lock washers

Cable Requirement:

LINC SIDE	DF32 Side
ME34	C09
MF34	C10
ME35	C11
MF35	C12
PE02	C13
PF02	C14
PH04	C15
PJ04	C16
PH08 (See Note #1)	C17
PJ08	C18
ME30 (See Note #2)	C19

NOTE #1:

These four (4) cables go from these processor connectors to the data terminal panel in a standard Linc-8. However, since the DF32 must use these signals and they are not available any place else in the existing logic, they must be removed and replaced by the cables going to the DF32. The four cables that were there should be taken back to the field office.

NOTE #2:

This is the cable required for the extended address bits if extended memory is to be used with the disk. However, if you will notice, this cable slot is already being used for LINC addressing and we cannot pick up these signals anywhere else.

In order to be able to use the disk, or any other 3 cycle break device with extended memory, a modification must be put in the machine. This change must be requested from Maynard. When requested this info ask for the "Print Title Linc-DF32 to Extended Memory #d-WL-7605427-0-0".

Title DF32 DISK ON LINC-8 (Continued)						Tech Tip Number DF32-TT-8		
All	Processor Applicability					Author	Rev	Cross Reference
						D. Crowther	0	
L8						Approval	Date	
						H. Long	09/14/72	

Notes of Interest:

Linc-8 ECO's 24 and 25 must be installed in the system before the disk will run correctly. Also make sure that the R302 delay is disable break out, which is part of ECO #25, is set correctly at 750 ns.

It has also been on a few systems that there has been excessive noise on the skip line in the DF32 logic. This can be cleared up by replacing a .01 capacitor through 100r terminator to ground on Pin C14K.

Something to Check:

Common wiring error found on previous installations:

Delete: PH10U to PH12R
PH10T to PD22K

Add: PH10U to PJ07U enable Linc
PH10T to PE07R disable cycle select
PH12R to PH12U 0-PC
PH12T to PD22K 5-11

PROBLEMS TO BE RUN TO INSURE RELIABILITY OF THE DF32 AND DS32 DISK'S ON A LINC-8.

- a) Diskless - MAINDEC-08-D5BA-D
- b) Diskdata - MAINDEC-08-D5CA-D
- c) Multidisk- MAINDEC-08-D5DA-D

If these diagnostics will run in their entirety and the rest of the Linc-8 still runs correctly you should be all set.

/mt

digital	FIELD SERVICE TECHNICAL MANUAL				Option or Designator
	12 Bit <input checked="" type="checkbox"/>	16 Bit <input type="checkbox"/>	18 Bit <input type="checkbox"/>	36 Bit <input type="checkbox"/>	DF32

Title DF32 TIMING TRACK WRITER				Tech Tip Number DF32-TT-9	
All	Processor Applicability	Author Bill Kochman	Rev 0	Cross Reference	
		Approval Frank Purcell	Date 07/31/72		

When modified for use with electronic photocell (see DF32 ECO #00043 or DS32 ECO #00009) a different operating characteristic may be encountered.

Symptom: After releasing write pushbutton, the writer continues writing timing.

Reason: P1 is incorrectly adjusted. If clock pulses are too far apart, timing will overlap the gap area causing this symptom.

Correction: Adjust P1 until gap area can be adjusted properly. The R401 clock in the TTW controls coarse P1 adjustment and may be out of adjustment if P1 cannot obtain proper results. Clock pulses should be approximately .54 usec apart for 60 cycle and .66 usec apart for 50 cycle operation.

For this reason, when writing timing, whether on a disk with or without photocell, the gap area must be examined after releasing the write button.

Title DISK MOTOR BEARING FAULTS DF AND RF				Tech Tip Number DF32-TT-10	
All	Processor Applicability	Author Carl Cline	Rev 0	Cross Reference	
		Approval W.E.Cummins	Date Aug 72		

When a bearing wears in the DF-32 or the RF08 it frequently will give intermittent errors, generally in the form of bit drops. It is then necessary to examine the data amplifier output to confirm that a fault is in the motor.

A faulty motor will rotate in an uneven pattern because of looseness between the shaft and bearings, and this can be seen as a phase shift between the plus patterns on the data tracks as compared with the TTA Timing Pulses. The inner data tracks will have the greatest shift and therefore be the most to fail and the most noticeably out of phase. On some motors only vibration will cause this effect.

This problem may temporarily be corrected by increasing the gain of the data amplifier which in turn will increase the width of the sliced output to be strobed. The following diagram illustrates this problem and the test points for placing scope probes.

Using the subtests provided in the Disk Data Tests, write all ones on all tracks. Then use the track selection test also provided in the Data Tests. One of the following should be observed.

Title DF32 DISK ON LINC-8						Tech Tip Number DF32-TT-11	
All Processor Applicability		Author D. Crowther		Rev 0		Cross Reference	
x		Approval H. Long		Date 09/14/72			

Hardware needed to add a cab onto a LINC-8:

- All trim should be black
- 3 - Center clips #74-5345
- 1 - Cab top spacer #74-5343
- 2 - Fillers #74-5347
- 3 - Flat c ips #74-5344
- 24 - 10-32-5/8" screws
- 24 - #10 External lock washers

Cable Requirement:

	<u>LINC SIDE</u>	<u>DF32 SIDE</u>
	ME34	C09
	MF34	C10
	ME35	C11
	MF35	C12
	PE02	C13
	PF02	C14
	PH04	C15
See Note #1	PJ04	C16
	PH08	C17
	PJ08	C18
See Note #2	ME30	C19

NOTE #1: These four (4) cables go from these processor connectors to the data terminal panel in a standard Linc-8. However, since the DF32 must use these signals and they are not available any place else in the existing logic, they must be removed and replaced by the cables going to the DF32. The four cables that were there should be taken back to the field office.

NOTE #2: This is the cable required for the extended address bits if extended memory is to be used with the disk. However, if you will notice, this cable slot is already being used for Linc addressing and we cannot pick up these signals anywhere else.

In order to be able to use the disk, or any other 3 cycle break device with extended memory, a modification must be put in the machine. This change must be requested from Maynard. When requested this information ask for the "Print Title Linc-DF32 to Extended Memory #d-WL-7605427-0-0".

Notes of Interest:

Linc-8 ECO's 24 and 25 must be installed in the system before the disk will run correctly. Also make sure that the R302 delay is disable break out, which is part of ECO #25, is set correctly at 750 ns.

digital	FIELD SERVICE TECHNICAL MANUAL				Option or Designator
	12 Bit <input checked="" type="checkbox"/>	16 Bit <input type="checkbox"/>	18 Bit <input type="checkbox"/>	36 Bit <input type="checkbox"/>	DF32

Title DF32 DISK ON LINC-8 (Continued)				Tech Tip Number DF32-TT-11	
All	Processor Applicability			Author D. Crowther	Rev 0
X				Approval H. Long	Date 09/14/72
					Cross Reference

It has also been noticed on a few systems that there has been excessive noise on the skip line in the DF32 logic. This can be cleared up by placing a .01 capacitor through 100 r terminator to ground on pin C14K.

Something to Check:

Common wiring error found on previous installations:

Delete:

PH10U to PH12R
PH10T to PD22K

Add:

PH10U to PJ07U enable linc.
PH10T to PE07R disable cycle select
PH12R to PH12U 0-PC
PH12T to PD22K 5-11

PROBLEMS TO BE RUN TO INSURE RELIABILITY OF THE DF32 AND DS32 DISK'S ON A LINC-8.

- a) Discless - MAINDEC-08-D5BA-D
- b) Disdata - MAINDEC-08-D5CA-D
- c) Multidisc- MAINDEC-08-D5DA-D

If these diagnostics will run in their entirety and the rest of the Linc-8 still runs correctly you should be all set.

NOTES

digital	FIELD SERVICE TECHNICAL MANUAL				Option or Designator
	12 Bit <input checked="" type="checkbox"/>	16 Bit <input type="checkbox"/>	18 Bit <input type="checkbox"/>	36 Bit <input type="checkbox"/>	DF32

Title DF32 & TTW ADJUSTMENT & CHECKOUT PROCEDURE					Tech Tip Number DF32-TT-12	
All Processor Applicability			Author Turcotte/Herbener		Rev A	
X			Approval F. Purcell		Date 11/02/72	
Cross Reference						

The following Tech Tip is divided into five (5) Sections:

- A. Synopsis of DF32 ECO & TTW Problems and Corrections
- B. Set Up and Checkout of DF32 TTW
- C. Procedure to write timing on a DF32 with or without photocell input.
- D. Electrical Adjustment Procedure for DF32
- E. Representative Scope Waveforms

The following procedures assume the timing track writer has ECO #43 installed. This applies to all DF32 TTW's.

This Tech Tip supersedes Old Tech Tip DF32-TT-3 and DF32-TT-9 or 8I Tech Tip Section 9 pages 13 through 16 and 8I Tech Tip Section 9 page 20. Also DF32 ECO#0043.

Title					Tech Tip	
DF32 & TTW ADJUSTMENT & CHECKOUT PROCEDURE (Con't)					Number DF32-TT- 13	
All		Processor Applicability		Author Turcotte/Herbener		Cross Reference
X				Rev A		
				Approval F. Purcell		Date 11/02/72

SECTION A

DF32 TTW ERROR AND CORRECTION LIST

At least two types of DF32 TTW's currently exist in the field. The old type is the grey metal case and the new type is the new brown leather case. There is no logic differences only packaging differences.

All new TTW's are being checked out prior to being released to the field. However, several older TTW's have been returned to Maynard because of problems experienced after installation of the ECO to modify the TTW to write in the same manner as the RF08 TTW.

- A. One major problem is noise being induced on the lines between the G284 modules, TTA normal/spare and TTB normal/spare switches, and the connector blocks for timing and data cables. This problem was overcome by replacing the lines between those points with two conductor shielded cable. The cable is the same as that used for the timing cable on the DFMA.
- B. On the old type TTW's, it was discovered that after the 12 wire change had been completed, the technician tied all lines together with cable ties or plastic harness and the noise problem then exists. After the 12 wire change has been installed, the TTW must be checked on the DFMA. The most common indication of the noise problem is that no erase cycle occurs. The lines between the G284 modules and the TTA normal/spare switches must be separated from all others. This must be done on a trial and error basis until it is found that the noise problem is overcome.
- C. Another problem in the new type TTW is a ground loop. The ground run between the data/timing connector block and the logic connector blocks must be removed. A ground run from the data/timing connector blocks should be made to one of the front panel holding screws on the chassis.

The jumpers for the external R401 module should be installed on the pin side of connector block C1. This way, no R401 module will have to be modified. See "Set-up and Checkout Procedures" step 2.

digital	FIELD SERVICE TECHNICAL MANUAL				Option or Designator
	12 Bit <input checked="" type="checkbox"/>	16 Bit <input type="checkbox"/>	18 Bit <input type="checkbox"/>	36 Bit <input type="checkbox"/>	DF32

Title DF32 & TTW ADJUSTMENT & CHECKOUT PROCEDURE (Con't)				Tech Tip Number DF32-TT-12	
All	Processor Applicability			Author Turcotte/Herbener Rev A	Cross Reference
x				Approval F. Purcell Date 11/02/72	

ECO ERROR AND CORRECTION LIST

Reference ECO DF32-00043

Error Page #1

Break-in point reads - #433 and Future.

Correction: #433 and Future
up to #432 ECO-006 must be installed

Error Page #1 reads

This ECO cannot be installed in units No. 0-433.

Should read:

Units 0-432 can be modified by installing
ECO #6 and ECO #43.

Error Page #2

Step #4 of method to adjust stimulated photogap pulse.
Reads - continue two turns to ensure good margin.

Correction: Two turns may offset the balance of the
guard bands and cause problems.

The correct set up: is covered in the new procedures.

Error Pages #4 and #5 - Delete pages #4 and #5 due to the
fact that these procedures have been followed in the field,
step by step, and have never worked correctly. Part C of
this report has been proven and should be followed by
all technicians.

Error Page #7 reads

GND C27P C27L Add

should read:

GND C27P C27C Add

Title DF32 & TTW ADJUSTMENT & CHECKOUT PROCEDURE (Con't)						Tech Tip Number	DF32-TT-12			
All	Processor Applicability					Author	Turcotte/Herbener	Rev	A	Cross Reference
X						Approval	F. Purcell	Date	11/02/72	

PDP-8I TECH TIP ERROR AND CORRECTION LIST

Reference DF32 Tech Tip #3 pages 3 and 4.

Error - These pages are identical to the procedures in ECO DF32-00043. Delete pages 3 and 4.

Correction: Refer to Section C of this report.

Add-Delete Synopsis

DF32 ECO #43 Add-Delete List

<u>Signal Name</u>	<u>DF32</u>	<u>DS32</u>	<u>Add-Delete</u>
PCA	A05D-A12V	C12D-D16J	Delete
PCA	A12V-A30P	D16J-D22H	"
Delete photo	amplifier	and platter tape	in DFMA.
PCA	C28D-C28F	C17D-C17F	Add
PCA	C28F-C27N	C17F-C16N	"
PCA	C27N-A30P	C16N-D16J	"
PCA	C28P-C28R	C17P-C17R	"
PCA	C28T-C27V	C17T-C16V	"
GND	C28U-C27P	C17U-C16P	"
GND	C27P-C27C	C16P-C16C	"
TTA	C28V-B21P	C17V-D22D	"
	C27S-C27T	C16S-C16T	"
.01 μ F CAP	C28J-C28U	C17J-C17U	"
.015 μ F CAP	C27R-C27S	C16R-C16S	"

In DF32 Add R302 module in C27 and R303 in C28
In DS32 Add R303 in C17

ECO FOR TIMING TRACK WRITER

B11F to B11C	Delete
B11F " B11P	"
A15N " A15F	"
A15U " A14T	"
A15U " A15N	"
A13V " A15P	"
A14T " A15U	Add
A15U " A15F	"
A15T " B11P	"
B05V " B11F	"
B01U " A15N	"
B05P " A15P	"

digital	FIELD SERVICE TECHNICAL MANUAL				Option or Designator
	12 Bit <input checked="" type="checkbox"/>	16 Bit <input type="checkbox"/>	18 Bit <input type="checkbox"/>	36 Bit <input type="checkbox"/>	DF32

Title DF32 7 TTW ADJUSTMENT & CHECKOUT PROCEDURE (Con't)				Tech Tip DF32-TT-12 Number	
All	Processor Applicability			Author Turcotte/Purcell Rev A	
X				Approval F. Purcell	Date 11/02/72
					Cross Reference

SECTION B

Set-up and Checkout Procedures for DF32 TTW after Electronic photocell ECO has been installed.

- A. The following may be accomplished without connecting the DFMA timing cable.
1. Connect power cables to proper source.
 2. Insert R401 module in connector "C1" or "DATA". Connector should have jumpers F H, L R, T U.
 3. Turn on power.
 4. Observe Jack 9 and adjust P3 for a 100 usec output (Ref. Figure #1).
 5. While observing Jack 9, adjust the pot on the external R401 module until the pules are:
 - 36 msec apart for 60 Hz
 - 42 msec apart for 50 Hz
 (Ref. Figure #2)
 6. Observe Jack 8, while depressing write 2, adjust P2 for a 250 Usec output. (Ref. Figure #3)
 7. Observe Jack 7, again while depressing write 2, the output should resemble Figure #8, leading edge to leading edge should be approximately 600 nsec for 60 Hz. (675 for 50 Hz.) **Figure #8 represents 200 nsec per CM. If adjustment is necessary, go to 7A.**
 - 7A. Set P1 to MID Range (this is a 10 turn pot), follow step 7 and observe the output at Jack 7. Adjustment is made by turning the pot on the internal R401 module.
 - 7B. The following must be accomplished with the DFMA timing cable inserted:
 1. Observe Jack 1, 2, 3, or 4.
 2. Set scope to 20 msec per CM.
 3. Press write 1 to on (light should be on).
 4. Depress write 2 and observe scope. Display should resemble Figure #9. (This shows that both the write and the erase cycles are occurring). If the display does not resemble Figure #9 and the cycle is a continuous write, an internal noise problem exists. Refer to (Synopsis of Error and Correction Lists).

Title DF32 & TTW ADJUSTMENT & CHECKOUT PROCEDURE (Con't)						Tech Tip Number DF32-TT-12		
All		Processor Applicability				Author Turcotte/Herbener	Rev A	Cross Reference
X					Approval F. Purcell	Date 11/02/72		

Set-up and Checkout Procedures for DF32 TTW after Electronic photocell ECO has been installed. CONTINUED

A. 7B. continued

5. If all of the above has been accomplished, you may now proceed with the procedure for writing timing. Refer to "Procedure to write timing on a DF32 with or without photocell input."

SECTION C
PROCEDURE FOR WRITING TIMING ON DF32 WITH OR WITHOUT
PHOTOCELL INPUT

1. Power down the system. Connect voltage leads from the TTW to the terminal strip located on the left side of the DF32 logic assembly.

Blue = -15V, Red = +10V, Black = GND
2. Remove timing cable from disk logic location B31 or B32 and insert in connector "C2" or "timing" on TTW.
3. With Photocell - remove data cable from disk logic location A5 and insert in connector "C1" or "data" on TTW. Go to step 4.
4. Apply power to system. With channel 1 observe Jack 9 and adjust P3 for 100 usec output. Reference Figure 1.
 - A. With Photocell - go to step 5.
 - B. Without photocell - while observing Jack 9, adjust the pot on the R401 until the pulses are 36 msec apart for 60 hz and 42 msec apart for 50 hz. Reference Figure 2, go to step 5.
5. Press write 1 to on (light should be on). While depressing write 2, observe Jack 8 and adjust P2 for 250 usec output. Reference Figure 3. Release write 2.
6. Observe TTA's (Timing Track) at Jack 1. Reference Figure 4.

Using delayed sweep mode, ensure that the gap area is 350 usec, as in Figure 5. If not, adjust P1 and momentarily depress write 2. Again, check for 350 usec gap.
7. Press write 1 to off (light should be off). (Display on scope will disappear.)

Power system down. Reinsert cables in proper slots and disconnect voltage leads from terminal strip.

COMPANY CONFIDENTIAL

digital	FIELD SERVICE TECHNICAL MANUAL				Option or Designator
	12 Bit <input checked="" type="checkbox"/>	16 Bit <input type="checkbox"/>	18 Bit <input type="checkbox"/>	36 Bit <input type="checkbox"/>	DF32

Title DF32 & TTW ADJUSTMENT & CHECKOUT PROCEDURE (Con't)				Tech Tip Number DF32-TT-12	
All	Processor Applicability			Author Turcotte/Herbener	Rev A
X				Approval F. Purcell	Date 11/02/72
					Cross Reference

PROCEDURE FOR WRITING TIMING ON DF32 WITH OR WITHOUT PHOTOCELL INPUT (continued)

8. Apply power to system. With channel 1 observe PCA at A30P (DF32) D16J (DS32). With channel 2 observe TTA's at A31P (DF32) C23P (DS32). Set scope to delayed sweep and add mode.
 - A. With photocell - display should be the same as Figure 6. Guard band on right hand side must be at least 50 usec.
 - B. Without photocell - display will resemble Figure 6 or 7.
 1. Adjust the lower pot on the R302 module in location C27 (DF32) C16 (DS32) until the pulse width is 200 usec.
 2. Adjust the pot on the R303 module in location C28 (DF32) C17 (DS32) until the guard band on the right hand side is 50 usec. The display should be the same as Figure 6.

Disk timing is now correctly adjusted and ready for operation.

NOTE: Figure 7 represents a misadjusted R302 and/or R303 module.

Delayed Sweep Setting for "0" Scope

Checking Gap Area

Time per div. - 5 msec
 Delayed sweep time per div. - 50 usec
 "B" sweep mode - "B" starts after delay time
 Horizontal display - delayed sweep
 "A" triggering - line
 Coupling - AC or DC
 "A" sweep mode - auto trigger.
 Mode - channel 1

Checking Photocell in Gap area

Same as above with one exception: mode - add

COMPANY CONFIDENTIAL

Title DF32 & TTW ADJUSTMENT & CHECKOUT PROCEDURE (Con't)						Tech Tip Number DF32-TT-12		
All X	Processor Applicability					Author Turcotte/Herbener	Rev A	Cross Reference
						Approval F. Purcell	Date 11/02/72	

ELECTRICAL ADJUSTMENT PROCEDURE FOR DF32

1. Power the system up and insure the disk motor is running. Logic power should now be on.
2. If good timing is on the disk you may proceed with the following adjustments. Otherwise follow "Procedure for writing timing with or without photocell input."
3. Put probes 1 and 2 on pins J and K of B30 in DF32 (C22 in DS32). Set scope up as follows:

Time/Div - 5 msec
 "A" Trigger - Internal
 Coupling - AC or DC
 "A" sweep mode - Auto Trigger
 Mode - Add
 Sensitivity - 2 V/Div
 Invert Channel "B"

Now adjust top pot on G083 in A32 (D23 in DS32) for average peak-to-peak amplitude of 9.0 volts.

4. With scope set up as in step 3, look at pins P & R of A31 in DF32 (C22 in DS32). Adjust bottom pot of G083 in A32 (D23 in DS32) for same signal characteristics as in step 3.
5. Set scope up as follows:

Time/Div - 0.2 usec
 "A" triggering - Internal
 Coupling - AC or DC
 "A" sweep mode - auto trigger
 Mode - Alternate
 Sensitivity - 2 V/Div

DO NOT INVERT CHANNEL "B"

With probe 1 look at the strobe pulse on pin V of B30 in DF32 (C22 in DS32) and with probe 2 look at the analog signal on pin J or K of B30 in DF32 (C22 in DS32). Adjust bottom pot on R302 in A14 of DF32 such that the positive transition of the strobe pulse on pin V occurs at the center or just a bit to the right of center of the analog signal on pin J or K.

IMPORTANT NOTE: On multi-disk systems both disks should have the same gap area as this adjustment affects both the DF32 and the DS32.

digital	FIELD SERVICE TECHNICAL MANUAL				Option or Designator	
	12 Bit <input checked="" type="checkbox"/>	16 Bit <input type="checkbox"/>	18 Bit <input type="checkbox"/>	36 Bit <input type="checkbox"/>	DF32	
Title DF32 & TTW ADJUSTMENT & CHECKOUT PROCEDURE (Con't)					Tech Tip DF32-TT-12 Number	
All	Processor Applicability				Author Turcotte/Herbener Rev A	Cross Reference
X					Approval F. Purcell Date 11/02/72	

ELECTRICAL ADJUSTMENT PROCEDURE FOR DF32 (continued)

6. Using the disk data test, write all ones on all tracks of the disk. Now read back one track at a time while looking at pins J and K of A10 in DF32 (C14 in DS32) with scope set up as in step 3. Adjust the top pot of the G083 in A8 in DF32 (C13 in DS32) such that lowest track is no lower than 8.0 volts average peak-to-peak amplitude and highest track is no higher than 10.0 volts.

7. Set up the scope as in step 5. Look at pin of W533 in A10 (C14 in DS32) **insert and adjust top pot of R302 in A14 (C16 in DS32) so that positive transition of the strobe pulse on pin V occurs at center or just to right of center of analog.** signal on pins J or K. This adjusts the strobe pulse for data and will vary according to track amplitude. It is imperative that the track selected to set this adjustment must be of average amplitude in relation to the other 16 tracks and must not be either close to the highest or lowest measured amplitudes.

8. Disk data must now be run in entirety. The timing and data tracks may have to be fine tuned for amplitude if there are any data failures. A moderate increase or decrease in amplitude (less than 1.0 volts) should not require a repositioning of the strobe signal.

Title DF32 & TTW ADJUSTMENT & CHECKOUT PROCEDURE (Cont)				Tech Tip Number DF32-TT- 12	
All	Processor Applicability			Author Turcotte/Herbener Rev A	Cross Reference
X				Approval F. Purcell Date 11/02/72	

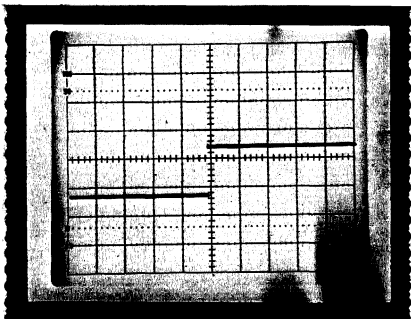

FIGURE 1

Time/Div = 20 μ sec

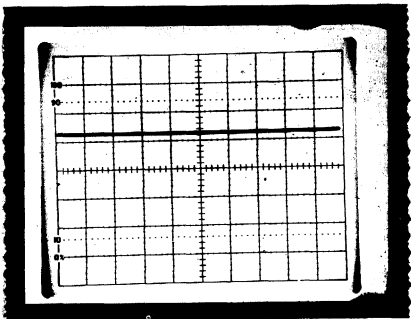

FIGURE 2

Time/Div = 5 Msec

digital	FIELD SERVICE TECHNICAL MANUAL				Option or Designator
	12 Bit <input checked="" type="checkbox"/>	16 Bit <input type="checkbox"/>	18 Bit <input type="checkbox"/>	36 Bit <input type="checkbox"/>	DF32

Title DF32 & TTW ADJUSTMENT & CHECKOUT PROCEDURE (Con't)				Tech Tip Number	DF32-TT- 12
All	Processor Applicability	Author	Turcotte/Herbener	Rev	A
X		Approval	F. Purcell	Date	11/02/72
					Cross Reference

FIGURE 3

Time/Div = 50 μ sec

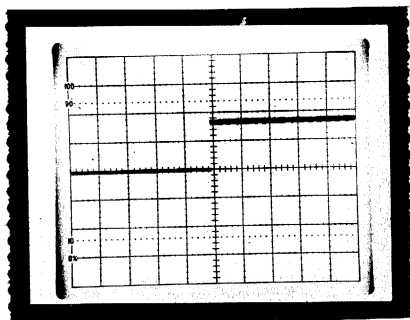
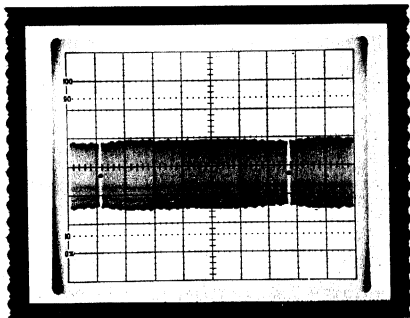

FIGURE 4

Time/Div = 5 M sec



Title DF32 & TTW ADJUSTMENT & CHECKOUT PROCEDURE (Cont)					Tech Tip DF32-TT- 12 Number	
All Processor Applicability			Author Turcotte/Herbener Rev A		Cross Reference	
X						

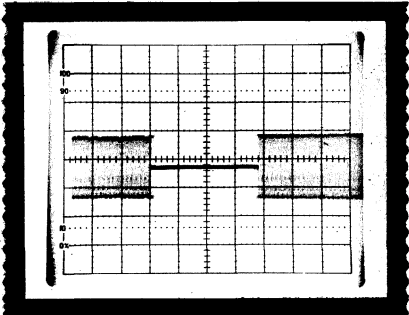

FIGURE 5
Time/Div = 100 μ sec.

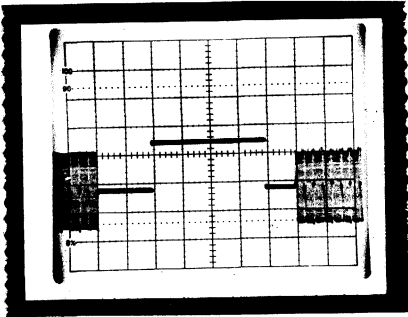

FIGURE 6
Time/Div = 50 μ sec.

digital	FIELD SERVICE TECHNICAL MANUAL				Option or Designator
	12 Bit <input checked="" type="checkbox"/>	16 Bit <input type="checkbox"/>	18 Bit <input type="checkbox"/>	36 Bit <input type="checkbox"/>	DF32

Title DF32 & TTW ADJUSTMENT & CHECKOUT PROCEDURE (Cont)				Tech Tip Number DF32-TT-12	
All	Processor Applicability			Author Turcotte/Herbener	Rev A
X				Approval F. Purcell	Date 11/02/72
					Cross Reference

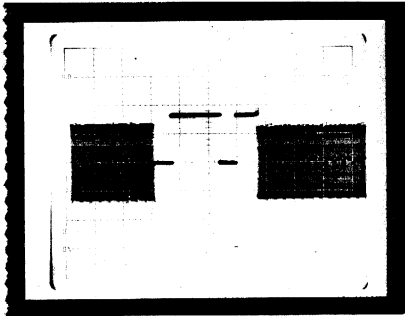

FIGURE 7

Time/Div = 100 μ sec

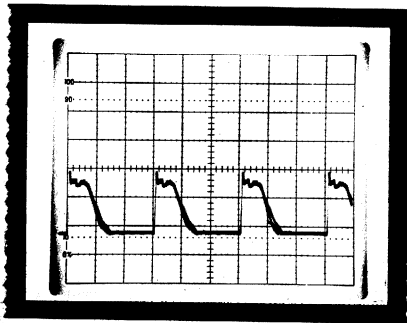

FIGURE 8

Time/Div. = 200 N sec

Title DF32 & TTW ADJUSTMENT & CHECKOUT PROCEDURE (Cont)						Tech Tip Number DF32-TT- 12	
All Processor Applicability			Author Turcotte/Herbener		Rev A		Cross Reference
X			Approval F. Purcell		Date 11/02/72		

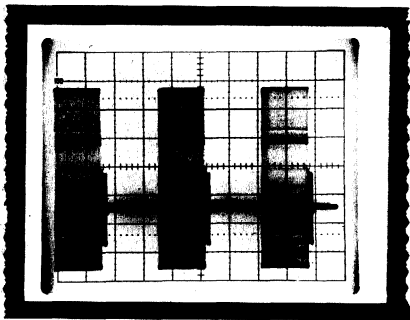

Figure 9

Time/Div = 20 Msec

digital	FIELD SERVICE TECHNICAL MANUAL				Option or Designator
	12 Bit <input checked="" type="checkbox"/>	16 Bit <input type="checkbox"/>	18 Bit <input type="checkbox"/>	36 Bit <input type="checkbox"/>	DF32

Title				RUNNING OF DISKLESS ON DF32 W/ELECTRONIC PHOTO-CELL MODIFICATION (ECO DF32-00043)		Tech Tip Number	DF32-TT-13
All 8's	Processor Applicability			Author	Ray Turcotte	Rev	0
				Approval	F. Purcell	Date	12/08/72
							Cross Reference

A. Running of Diskless on DF32 with Electronic Photo-Cell modification (ECO DF32-00043).

- When running diskless on a modified DF32 a PSM error typeout will occur: 1043 4000
- To eliminate this error, remove the R303 module in location C28 of the DF32 (C17 or DS32).

The reason for this error is that the output of the R303 remains at ground level and therefore represents a true photo sync mark to the logic.

B. Running of Diskless on DF32 without Electronics Photo-cell.

- When running diskless on an unmodified DF32, it is possible to get a PSM error typeout: 1043 4000
- This will occur if the photo-cell AMP assembly is facing the reflective portion of the Disk platter. This can be overcome by means of the disk motor AC switch. Apply power to the motor and then remove power. This will reposition the reflective portion of the platter in relation to the photo-cell amp.

Title				LOOSE TERMI-POINT CONNECTORS		Tech Tip Number	DF32-TT-14
All 8's	Processor Applicability			Author	Ken Latta	Rev	0
				Approval	W. Cummins	Date	04/04/73
							Cross Reference

PROBLEM: The termi-point connectors used to connect the unit select switch and write lock switches to the back plane tend to lose their grip on the pin. When this happens contact may be lost very intermittently. The loss of contact will cause deselection of the disk. If this occurs during a write operation, there will be no error indications but bad data and bad parity will be written.

To correct or prevent this problem, solder the termi-point connectors to the logic pins. Wirewrapping is not practical due to the use of stranded wire.

Title Maladjusted DF-32 Head Springs						Tech Tip Number DF32-TT15		
All	Processor Applicability					Author	Rev	Cross Reference
	8	8I	8L	8E		W. Freeman	0	
						Approval	Date	
						W. E. Cummins	12/5/73	

Under no circumstances should DF-32 head springs be adjusted in the field. Head springs are factory adjusted and should never be changed in the field. If, for some reason, a head spring is out of adjustment, the entire head assembly, including the mounting block, should be replaced. Plexiglass alignment disks, new head and block assemblies, along with timing track writers and instructions, are available in the Regional Offices. If a head needs to be changed, the job should be performed either by an experienced person or, in the case of an inexperienced person, with assistance.

Title DF32 Used with DM01						Tech Tip Number DF32-TT16		
All	Processor Applicability					Author	Rev	Cross Reference
	8	8I	8L	8E		W. Freeman	0	
						Approval	Date	
						W. E. Cummins	12/5/73	

Termination of ADD ACCP and WC OVERFLOW is required when a DF32 is used with a DM01. The terminators are standard 100 ohm resistors and should be added from C18P to ground and C16S to ground in the DF32 logic.

All DF32 termination is removed by ECO DF32-00004 when the disk is on an 8/I. If the disk is operated through a DM01 on an 8/I, however, the two terminators described above are required.

Title CONFLICTING IOT's, DF32 and CR03						Tech Tip Number DF32-TT17		
All	Processor Applicability					Author	Rev	Cross Reference
	8	8I	8L	8E		W. Freeman	0	
						Approval	Date	
						W. Cummins	12/5/73	

Both the DF32 and CR03 were assigned the IOT instruction 663X. The DF32 uses this IOT for maintenance purposes. We therefore have a problem when we have a system with both a DF32 and a CR03 interfaced.

Temporary solutions:

- A) When system is on line:
 - 1) Remove W103 (CD21, disk control)

digital	FIELD SERVICE TECHNICAL MANUAL				Option or Designator
	12 Bit <input checked="" type="checkbox"/>	16 Bit <input type="checkbox"/>	18 Bit <input type="checkbox"/>	36 Bit <input type="checkbox"/>	DF32

Title CONFLICTING IOT's, DF32 and CR03 (cont.)				Tech Tip Number DF32-TT17	
All	Processor Applicability			Author W. Freeman	Rev 0
	8	8I	8L	8E	
				Approval W.E.Cummins	Date 12/6/73
					Cross Reference

B) When performing maintenance on the disk (running disk maindecs):

- 1) Insert W103 (CD21, disk control)
- 2) Disconnect CR03 from "8"-bus (AB13)

An ECO has been prepared for elimination of this problem; it is ECO DF32-00008.

Title DF32/85 Case History				Tech Tip Number DF32-TT18	
All	Processor Applicability			Author W. Freeman	Rev 0
	8	8I	8L	8E	
				Approval W.E.Cummins	Date 12/6/73
					Cross Reference

The system in question is located in a high noise environment and, every so often, while the customer was running his program, he would lose one character while doing a read from the disk.

Field Service made one call to the site, but at the time, the customer's machines were being worked on, and the noise level was very low, and consequently, everything that was tried worked correctly.

The problem was found through the efforts of Russell Chambers, of the Alcoa Company. Russ found that in the OMD8S (print D-BS-DB8S-0-1 (PB8S), the signal "Increment CA", pin M of the W021, location 1A10 was floating. This is normal, because this signal is not used in the DF32; however, due to the environment of the system location, every now and then increment CA would change, due to noise and, thus, the customer would lose one character while transferring from the disk. What Russ did to correct this was to clamp the signal at Pin U of the R113, located in slot 1D9 (print location C,4).

Russ also pointed out that the signal "Increment MC", on the W021, location 1A8, is also floating; but, up to this point, has not given him any trouble.

Title DF32 LOGIC/PROGRAMMING PROBLEM						Tech Tip Number DF32-TT19		
All	Processor Applicability					Author W. Freeman	Rev 0	Cross Reference
	8	8I	8L	8E		Approval W.E. Cummins	Date 12/11/73	

When loading DF32 Extended Address with instruction 6615 the AC should be unchanged. If, however, the instruction coincides with the Photo Sync Mark signal, AC bit 0 will be set to a one by IOT 614, which may result in the customer's program being upset. Customers should be advised of the existence of this problem, for which there is no solution at this time.

Title DF32 - RF08 Clean Procedure						Tech Tip Number DF32-TT20		
All	Processor Applicability					Author W. Freeman	Rev 0	Cross Reference
	8	8I	8L	8E		Approval W. E. Cummins	Date 12/12/73	

Even though the platter surface appears to be absolutely clean, wash it thoroughly with a mild soap, such as Ivory, and water. Clean the head surfaces with the pressurized aerosol form of MS200 magnetic tape head cleaner.

Title DF32 MOTOR WIRING						Tech Tip Number DF32-TT21		
All	Processor Applicability					Author W. Freeman	Rev 0	Cross Reference
	8	8I	8L	8E		Approval W.E. Cummins	Date 12/12/73	

All DF32 motors should have 115 volts at the power input regardless of other notations on the motor name plate. If 230 volts is involved, a stepdown transformer must be used between the supply and the motor. If the motor has four wires, plug in according to color code; if the motor has six wires, splice the blue and white together and the green and black together. Plug the splice with the green wire to the green tape and the splice with the blue wire to the blue tape.

digital	FIELD SERVICE TECHNICAL MANUAL				Option or Designator
	12 Bit <input checked="" type="checkbox"/>	16 Bit <input type="checkbox"/>	18 Bit <input type="checkbox"/>	36 Bit <input type="checkbox"/>	DF32 to DF32D

Title ECO DF32-00047 ERRORS				Tech Tip Number DF32-TT-22	
All Processor Applicability		Author R. Turcotte		Rev 0	
X		Approval D. Staupe		Date 7/1/74	
				Cross Reference	

ECO DF32-00047 presently contains two wiring errors. If a new logic backplane is ordered from stock, it also is in error. The following will show the error and the correction.

	SIGNAL	FROM PIN	TO PIN	COMPONENT
Reads:	TTA	C28V	B28K	-
Should Read:	TTA	C28V	B21P	-
Reads:	-	C28S	C28U	.01UF CAP
Should Read:	-	C28J	C28U	.01UF CAP

Title DF32D INFORMATION				Tech Tip Number DF32D-TT-1	
All Processor Applicability		Author W. Kochman		Rev 0	
8I		Approval W. Cummins		Date 07/31/72	
				Cross Reference	

- 1) The DF32D & E may use either M206 or M216 FFS. If the M206 is used, jumpers must be connected from A1 to FF2 and FF1. This is the standard jumper configuration of an M206. The same holds true for the timing track writer modules.
- 2) Since there is presently no UML for the TTW, the one below should suffice until it is available. Extensive changes make the early DF32D & E Manual TTW prints obsolete, so you will have to reference the prints shipped with your TTW. The manual, however, gives general theory, operation, and adjustment adequately.

DF32D & E TTW MODULE LOCATIONS

	1	2	3	4	5	6	7	8	9	10	11	12	13	14	15	16
A	G 085	G 085	G 294	G 294		M 111	M 233	M 115	M 117	M 206	M 205	M 113	M 115	M 115	M 113	M 206
B	G 085	G 085	G 294	G 294	M 506	M 602	M 401	M 113	M 602	M 401	M 302	M 113				

- 3) New G085 module for DF32D, E only. G085 ECO 00006 deletes and adds a capacitor to make the module less susceptible to noise from the DFMA heads. This was previously accomplished by adding 68 pf capacitors on the logic pins. The new module is labeled G0850 and is not interchangeable with the G085.

Title DF32D, E Noise Pickup						Tech Tip Number DF32D-TT-2		
All	Processor Applicability					Author Ray Turcotte	Rev 0	Cross Reference
	8E					Approval Frank Purcell	Date 07/31/72	

If BC08D or BC08D Flat Shielded Coax Cables are used, slot A30 should contain a G0850 Etch Module, not a G085 retrofitted to the level of a G0850. The reason is that the G085 Etch module has inadequate grounding circuitry due to the physical layout of the Etch; noise transfer between the cable in slot A29 and the module in slot A30 can cause extra TTA pulses in the amplifier. Most disks have BC08A Mylar Cable which cause not problems.

Title G0850 Read/Writers						Tech Tip Number DF32D-TT-3		
All	Processor Applicability					Author	Rev 0	Cross Reference
	12					Approval H. Long	Date 08.17.72	

Effective immediately, G0850 modules made from modified G085 modules are not acceptable for PDP12 systems. Only G0850's with G0850 Revision "B" etch are acceptable. This is because the true G0850 has a slightly different layout consisting of more grounding. It is hence less susceptible to noise from adjacent digital modules.

/mt

Title DF32D TTW Rev. B DOES NOT WRITE LAST TWO WORDS AS PER MANUAL						Tech Tip Number DF32D-TT-4		
All 8's	Processor Applicability					Author Turcotte/Herbener	Rev 0	Cross Reference
						Approval Frank Purcell	Date 01/24/73	

Some DF32-D Timing Track Writers may be wired correctly according to Rev. B prints. However the addressing sequence instead of being 3777, 6000, 4000 and 3 TTBS; it write 3777, 4000, 5000 and 3 TTBS. The following add-deletes to the track writer corrects this problem.

A13A1	A13J1	Delete
A13H1	A16E1	Delete
A15F1	A07V2	Delete
A15E1	A15F2	Delete
A14J1	A15D1	Delete
A13H1	A16F1	Add
A14N1	A07V2	Add
A15F2	A14K1	Add
A14J1	A14L1	Add
A13J1	A14M1	Add

The disk will work with either addressing scheme, but to conform to the manual this change may be done.

digital	FIELD SERVICE TECHNICAL MANUAL				Option or Designator DK8E
	12 Bit <input checked="" type="checkbox"/>	16 Bit <input type="checkbox"/>	18 Bit <input type="checkbox"/>	36 Bit <input type="checkbox"/>	

Title Timing Generator (M833) Mislabeled CS. REV. D.				Tech Tip Number DK8E TT-1		
All	Processor Applicability			Author Bill Moroney	Rev 0	Cross Reference
	8E			Approval W. Cummins	Date 07/31/72	

All M883 modules manufactured previous to July 1971 are C.S. revision C. Some M883 modules were erroneously marked revision D. Since each module has a date stamped on the handle as well as the C.S. revision those erroneously marked can easily be identified.

Title Changing DK8E Real Time Clock from 120Hz to 60Hz				Tech Tip Number DK8E TT-2		
All	Processor Applicability			Author Al Deluca	Rev 0	Cross Reference
	8E			Approval W. Cummins	Date 07/31/72	

The only modification that is required to the module is to delete two diodes (D3 and D5). These diodes are located in the upper left hand part of the module as shown in the picture below.

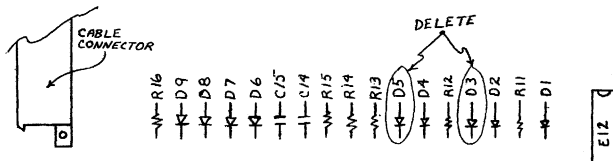

With these two diodes removed the DK8E clock diagnostics (Maindec-8E-D8AB-D-(D)) will not run. To have an operative diagnostic two locations will have to be changed. They are:

<u>Location</u>	<u>From</u>	<u>To</u>
5760	5367	2670
5666	5217	2520

With the completion of these modifications, you now have a 60 hz clock.

Title						Damage to Cable (KP8E and DK8EA)		Tech Tip		Number		DK8E-TT-3	
All		Processor Applicability				Author		Ken Asbury		Rev		0	
8M		8F				Approval		F. Purcell		Date		11/20/72	
												Cross Reference	

The cable harness going to the power fail (KP8E) or Real Time Clock (DK8EA) board (if installed) is liable to get mutilated on the edge of the power supply cover if the module is not removed carefully.

ECO 7409419-001 adds some 90-08209 grommet to the sharp edge to protect the cable.

Although not a Field retrofit change, it would be worthwhile to add this grommet strip to any systems in your area with clock or power fail, and also to take some grommet along when installing these options.

Title						Plus Five Volt Sensitivity		Tech Tip		Number		DK8E-TT-4	
All		Processor Applicability				Author		Bill Kochman		Rev		0	
8E		8F		8M		Approval		J. Blundell		Date		8/3/73	
												Cross Reference	

The M860 module derives BUS STROBE by a circuit that relies on plus 5V being no lower than 4.9V for reliable operation. The signal decreases in width with decrease in voltage. When the voltage is too low the processor will hang up while executing 6133 - it has missed BUS STROBE. So keep that plus 5V right on for machines with DK8E.

digital	FIELD SERVICE TECHNICAL MANUAL				Option or Designator
	12 Bit <input checked="" type="checkbox"/>	16 Bit <input type="checkbox"/>	18 Bit <input type="checkbox"/>	36 Bit <input type="checkbox"/>	DL8I to DM01

Title DL8I INSTALLATION IN EARLY PDP-8I's				Tech Tip Number	DL8I-TT-1			
All	Processor Applicability			Author	W. Cummins	Rev	0	Cross Reference
	8I			Approval	W. Cummins	Date	07/31/72	

The DL8I is factory wired into PDP-8I processor logic panels from serial number 788 upward. The machines below serial number 788 require ECO's 8I-00013 and 8I-00022; because of the complexity of these ECO's, they will not be field installed. The 8I logic panel must be exchanged at customer expense.

/mt

Title INTERMITTENT DATA ERRORS					Tech Tip Number	
All		Processor Applicability			Author R. Woodson	Rev A
		BI	BL		Approval	
					Date 9-30-74	
					Cross Reference	

SYMPTOMS: When running DEC-X8 or any other program that causes back to back breaks of 3 cycle and single cycle devices, data errors occur on single cycle device.

SOLUTION: Modify DM01 as shown below.

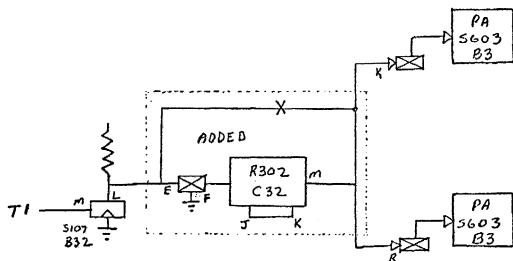

To adjust R302 for best operation pin M of the R302 should be initially set to rise to ground level at the leading edge of TS3 in the processor. Then a pattern of all ones should be written on a data break device (preferably a disk for scoping) to be read back during adjustment. To adjust get computer in loop reading back all ones pattern written earlier. While syncing on break (1) look at data out of an adder and MB load. MB load, the first one on sweep, should occur during the time a one (low) is coming out of the adder. The R302 should now be adjusted until the leading edge of MB load falls approx. 50 ns before the trailing edge of the one.

Routines for writing and reading all ones should be available in the devices diagnostics.

digital	FIELD SERVICE TECHNICAL MANUAL				Option or Designator
	12 Bit <input checked="" type="checkbox"/>	16 Bit <input type="checkbox"/>	18 Bit <input type="checkbox"/>	36 Bit <input type="checkbox"/>	DM01

Title DM01 UNDERRATED TRANSISTORS IN M633 MODULES				Tech Tip Number DM01-TT-2		
All	Processor Applicability			Author K. Ashbury	Rev 0	Cross Reference
	8	8I	8L	Approval F. Purcell	Date 06/21/72	

DEC 3639B Transistors are underrated for driving DM01. Their VCEO of 6 volts is exceeded when driving 1.5K at -15V. The 12 transistors on M633 modules should be replaced with DEC 6534B transistors (DEC Part Number 15-03409-01).

Title DIRECT MEMORY ACCESS MULTIPLEXERS (PDP-12)				Tech Tip Number DM01-TT-3		
All	Processor Applicability			Author H. Long	Rev 0	Cross Reference
	12			Approval H. Long	Date 08/17/72	

Two new signals, not present in Family-of-Eight Systems, are required in the DM01 and DM04 for proper break multiplexing.

If other options are present on the I/O bus prior to the multiplexer, check that the following signals are passed along:

Positive Bus: B BK SYNC CLK H CABLE 3 PIN T2
 EXT ENAB INT PAUSE H CABLE 3 PIN V2

Negative Bus: B BK SYNC CLK CABLE 6 PIN T
 EXT ENAB INT PAUSE CABLE 6 PIN V

Note that "B BK SYNC CLK" should be passed along no farther than the multiplexer due to lack of termination in the other devices.

Title DM01 MULTIPLE DEVICE NOISE PROBLEMS										Tech Tip Number DM01-TT-4			
All	Processor Applicability							Author		Rev		Cross Reference	
x								Approval H. Long		Date 08.17.72			

PDP-12's with DM01's have exhibited a noise problem on the cycle select line. The noise originates in the DM01 and is amplified and shaped while passing through the DM08. The following fix was originated by Del Hollingsworth PDP-12 Engineering:

1. Add R107 module to C32 DM01.
2. Install following wiring changes:

<u>Signal Name</u>	<u>From Pin</u>	<u>To Pin</u>	<u>Add</u>	<u>Delete</u>
C13D	C13D	B15S		X
3 volt Clamp	B15S	B11T		X
Cycle Select	B15R	A19L		X
	A19L	A10K		X
C13D	C13D	B11T	X	
C13D	C13D	C32E	X	
Cycle Select	A19L	A10K	X	
	C32D	A19L	X	

3. Insure cable run from DM01 to DW08 is as short as possible.

/mt

Title M633 NEG. BUS DRIVERS USED WITH DM01										Tech Tip Number DM01-TT-5			
All	Processor Applicability							Author F. Souva		Rev 0		Cross Reference	
x								Approval H. Long		Date 09/20/72			

The M633 uses a DEC 3639B transistor. It is overworked when driving a DM01 because the VCEO of 6 volts is exceeded by driving 1.5K to -15 volts. This will be evident on RK08's, DF32D's, FPPI2's and the like being interface through DM01 multiplexers.

ECO M633-00002 calls for changing the 3639B transistors to DEC 6534B. This transistor has a VCEO of 40.

digital	FIELD SERVICE TECHNICAL MANUAL				Option or Designator
	12 Bit <input checked="" type="checkbox"/>	16 Bit <input type="checkbox"/>	18 Bit <input type="checkbox"/>	36 Bit <input type="checkbox"/>	DM#1

Title				Tech Tip	
DM#1 ON DW#8/PDP-8E SYSTEMS				Number DM#1-TT-6	
All		Processor Applicability		Author R. Wilson	
8E				Rev 0	
				Cross Reference	
				Approval	
				Date 3-20-74	

Due to timing considerations, a DM01 or DM04 does not operate properly on a PDP-8E. The symptoms are that location 7776 in field zero gets incremented and locations in field 7 get altered.

The DM01 obtains the signal BRK REQUEST by a simple OR of the BRK REQ signals from the break devices. However, the MPX flops set at TP3 (or TP1, see DM01-TT-1) time to indicate which device gets the break being requested. Thus, if a break request comes between TP3 (or TP1) and TP4, the KD8E will take a break and the DM01 won't know which device to give it to. The break will be a 3-cycle break with the WC at 7776, the CA increment inhibited, and the break somewhere in field 7. The break originally desired then takes place normally.

To prevent the problem, the BRK REQUEST signal can be formed by ORing the output of the MPX flops. The following adds/deletes will accomplish this. It is only necessary to install the changes for the ports which are to be used; i.e., for 2 devices, only the first 10 adds/deletes need be installed.

This tech tip is not issued as a cure-all for compatibility problems between the DM04/DM01 and the PDP-8E. It is issued as a quick fix in the event that the customer did not receive the proper interface equipment. The Engineering Specs for the KD8E clearly state that a DM04/DM01 cannot be used on a 8E system.

Title DMØ1 ON DWØ8/PDP8E SYSTEMS (Cont.)					Tech Tip Number DMØ1-TT-6		
All	Processor Applicability				Author R. Wilson	Rev 0	Cross Reference
	8E				Approval	Date 3-20-74	

ADD/DELETE SHEET

MAKE ALL DELETIONS FIRST

SIGNAL NAME	PROM PIN	TO PIN		ADD	DEL
BRK REQ 0	B23K	DØRK			X
"	BØØD	B14T			X
"	B14L	B23K			X
"	B14L	DØ8K		X	
"	BØØD	B14L		X	
MPX Ø (1)	A13F	B23K		X	
BRK REQ 1	B16L	B23L			Y
"	B23L	D13K			Y
"	B16L	D13K		X	
MPX 1 (1)	A13H	B23L		X	
BRK REQ 2	B22D	D18K			Y
"	BØØF	B17L			Y
"	B17L	B22D			Y
"	B17L	D18K		X	
"	BØØF	B17L		X	
MPX 2 (1)	A13K	B22D		X	
BRK REQ 3	B18L	B22F			X
"	B22E	D23K			Y
"	B18L	D23K		X	
MPX 3 (1)	A13M	B22F		X	
BRK REQ 4	D2ØK	B22H			Y
"	BØØJ	B19L			X
"	B19L	B22H			Y
"	BØØJ	B19L		X	
"	B19L	D2ØK		X	
MPX 4 (1)	A13P	B22H		X	
BRK REQ 5	BØØK	B2ØJ			X
"	B2ØL	B22J			X
"	BØØK	B2ØL		X	
MPX 5 (1)	A13S	B22J		X	
BRK REQ 6	BØØL	B21L			X
"	B21L	B22L			X
"	BØØL	B21L		X	
MPX 6 (1)	A13U	B22L		X	

digital	FIELD SERVICE TECHNICAL MANUAL				Option or Designator
	12 Bit <input checked="" type="checkbox"/>	16 Bit <input type="checkbox"/>	18 Bit <input type="checkbox"/>	36 Bit <input type="checkbox"/>	DM04

Title DIRECT MEMORY ACCESS MULTIPLEXERS (PDP-12)				Tech Tip Number DM04-TT-1		
All	Processor Applicability			Author	Rev	Cross Reference
	12			Approval H. Long	Date 08.17.72	

Title ECO INCOMPATABILITY				Tech Tip Number DM04-TT- 2		
All	Processor Applicability			Author	Rev 0	Cross Reference
	12			Approval H. Long	Date 08.17.72	

ECO DM04-A0011, written for a standard DM04, does not fit if installed on a DM04 with ECO DM04-A0009 implemented.

Corrections:

BTS3 (1) H A18E2 to A01S2 (delete)

BRK CLK SYNC H A18E2 to B03T2 (add)

Additional and delete pairs to allow proper level phasing:

A03T2	B03T2	(del)
A01T2	B01T2	(del)
A01T2	B01T2	(add)
A03T2	B03T2	(add)

Title SIGNAL GLITCHING				Tech Tip Number DM04-TT-3		
All	Processor Applicability			Author	Rev	Cross Reference
		12		Approval H. Long	Date 08.17.72	

BRK CLK SYNC should not be passed along the I/O bus if a DM04 is used in the system. The last DM04 in the system should be modified as follows:

A03T2	B03T2	(del)
A18E2	B03T2	(del)
A18E2	A03T2	(add)

Note that this change will require that the source I/O bus be plugged into "A" row.

-- NOTES --

digital	FIELD SERVICE TECHNICAL MANUAL				Option or Designator DM1
	12 Bit <input checked="" type="checkbox"/>	16 Bit <input type="checkbox"/>	18 Bit <input type="checkbox"/>	36 Bit <input type="checkbox"/>	

Title <i>DM1/DM2 (DEC #11002933) PHYSICAL DIFFERENCES</i>				Tech Tip Number <i>DM1-TT-1</i>							
All Processor Applicability		Author <i>A. Newbery</i>	Rev <i>0</i>	Cross Reference							
<table border="1"> <tr> <td>8I</td> <td></td> <td></td> <td></td> <td></td> <td></td> </tr> </table>		8I						Approval <i>W. Cummins</i>	Date <i>07/31/72</i>		
8I											

Some confusion has arisen from the fact that DM-1 rectifier packages produced by Solatron have their physical terminal configuration shifted 90° with respect to those manufactured by Motorola. All internal connections, color coding, and electrical characteristics are identical for both units.

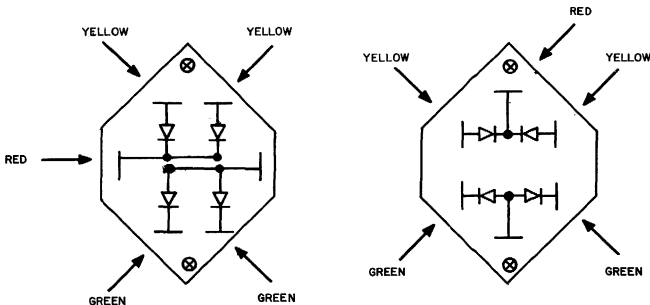

From Engineering Newsletter of Feb.10,1969

Title <i>DM1/DM2 INTERCHANGABILITY</i>				Tech Tip Number <i>DM1-TT-2</i>							
All Processor Applicability		Author <i>A. Newbery</i>	Rev <i>0</i>	Cross Reference							
<table border="1"> <tr> <td>8I</td> <td></td> <td></td> <td></td> <td></td> <td></td> </tr> </table>		8I						Approval <i>W. Cummins</i>	Date <i>06/31/72</i>		
8I											

There is one significant difference between the DM-1 and DM-2 rectifier which affects interchangeability. The inverse voltage rating for the DM-1 is 50 volts; it is 100 volts for the DM-2. All other specifications are identical including a forward voltage drop of 1 volt @ 10 amps.

A DM-2 may be installed to replace a DM-1.

COMPANY CONFIDENTIAL

Title DN-1/DN-2 HEAT DISSIPATION						Tech Tip Number DM1-TT-3		
All	Processor Applicability					Author A. Newbery	Rev 0	Cross Reference
	8I					Approval W. Cummins	Date 07/31/72	

It is imperative that prescribed procedure be followed in the mounting of the Solatron type (with metal base, as opposed to the all epoxy type) DN-1 and DN-2 rectifiers. A simple metal to metal mounting will not provide a reliable heat sink and premature failure of the rectifier may occur because of reduced heat dissipation.

A coating of DOW Corning "Compound #4" (silicon grease) should be applied to the mounting surface/s before the rectifier block is secured in place. This compound is stocked by the Field Service stockroom in 2 oz. tubes.

It is suggested that checking new systems for the presence of the compound may help to reduce the incidence of rectifier failure.

Title 230 VOLT, 50 Hz to 115 VOLT 60 Hz CONVERSION						Tech Tip Number DM1-TT-4		
All	Processor Applicability					Author C. Sweeney	Rev 0	Cross Reference
	8I					Approval W. Cummins	Date 07/31/72	

Conversion of the basic 8I involves the changing of the power plug and jumper connections in the 704 power supply; these changes are detailed on print 704-0-1 (jumping for several other AC line conditions is also included).

- 1) Remove cover plate from transformer to expose terminal strips.
- 2) Remove black jumper which ties terminal #8 to #13.
- 3) Add two jumpers to connect terminals #9 to #12 and #10 to #11.
- 4) Remove the white fan lead from terminal #9 (may be on #8) and connect it to #12.
- 5) Remove the black fan lead from terminal #8 (may be on #9) and connect it to #11.
- 6) Make the following changes:

Remove lead from Terminal #	20	19	18	17	16	15	14
Reconnect it to terminal#	1	2	3	4	5	6	7

- 7) Replace the cover plate.

For information on Teletype conversion see Tech Manual, Section 3.

In addition to the changing of jumpers in the power supply, there are two other concerns:

- 1) The AC power connector:
60 systems require a 30A Hubbel Connector
50 systems require a 20A Hubbel Connector.
- 2) Any thyrectors on the AC line:
240V systems require a 6RS2#SP9B9 thyrector, (DEC Part #112915)
110V systems require an SP4B4 thyrector, (DEC Part #11-#1#6).

digital	FIELD SERVICE TECHNICAL MANUAL				Option or Designator DP01
	12 Bit <input checked="" type="checkbox"/>	16 Bit <input type="checkbox"/>	18 Bit <input type="checkbox"/>	36 Bit <input type="checkbox"/>	

Title DP01A ON LINE DATA RELIABILITY				Tech Tip Number DP01 -TT-1		
All	Processor Applicability			Author Bill Freeman	Rev 0	Cross Reference
	8I	8L	8	Approval W. Cummins	Date 7-31-72	

Some DP01A's may exhibit the problem of data being received, shifted from its proper bit assignment. This may be caused by cross talk in the 70-5639 cable used to connect the DP01 to the data set. The way to check this is to have the remote terminal continually transmit sync characters. The following program will display this character in the PDP-8 accumulator:

7000	7200	CLA
7001	6634	STR/Set Terminal Ready
7002	6651	SRF/SKP REC FLG = 0
7003	7610	SKP CLA
7004	5202	JMP. -2
7005	6612	RRB/READ REC Buffer
7006	5202	JMP. -4

The accumulator should display the sync character; if cross talk is present, the character will shift randomly while being displayed.

There are presently two ways to correct this problem; one is to move the wires in the cable such that the receive clock and transmit clock are not running close enough to each other to cause cross talk. There are several spare wires in the cable that may be utilized for this purpose. The second method may be adding a capacitor to A5D to ground of the 637 portion of the DP01. For 2000 to 2400 baud speeds the capacitor may be 2200 mpf, for higher speeds this size may change the bit strobe time and a different size capacitor may be necessary.

Title DP01A Programs						Tech Tip DP01 -TT-2 Number				
All 8's	Processor Applicability					Author	W. Cummins	Rev	0	Cross Reference
						Approval	W. Cummins	Date	7-31-72	

There are six programs available for the DP01A:

Two to be used on line with a modem connected to the DP01A

1. Maindec 08-D8EB with device codes 30 thru 37
2. Maindec 08-D8KA with device codes 60 thru 67

Four for off-line use which do not require connection of a modem

3. Maindec 08-D9MA with device codes 30 thru 37
4. Maindec 08-D9NA with device codes 50 thru 57
5. Maindec 08-D9PA with device codes 60 thru 67
6. Maindec 08-D9QA with device codes 70 thru 77

Operational procedures for all above Maindecs are identical irrespective of the device coding.

Several groups of selection codes have been made available for the DP01A to make it possible to avoid conflicts with other devices; these maindecs have been prepared to cover this range of codes. As an example, a DP01A coded 60 thru 67 on a system with a DF32 Disk would result in a conflict of IOT's and a change of the DP01A codes to 30 thru 37 would be recommended:

digital	FIELD SERVICE TECHNICAL MANUAL				Option or Designator
	12 Bit <input checked="" type="checkbox"/>	16 Bit <input type="checkbox"/>	18 Bit <input type="checkbox"/>	36 Bit <input type="checkbox"/>	DP01

Title DP01 SETTING DELAYS				Tech Tip Number DP01-TT-3	
All Processor Applicability		Author	Rev		Cross Reference
8's		Approval W. Cummins	Date	7-31-72	

There are three adjustable delays in the DP01A which must be set for proper operation. These delays are associated with the receive logic and will be found on prints D-BS-637-0-1 and D-BS-637-0-3.

A delay of one microsecond is associated with the signal RB → RCB and can be adjusted by issuing the IOT 6X54 (where X is the first digit of the device code for the DP01A) and a JUMP back to the IOT. The resulting pulse may be taken from the W103 at A19S and applied to B17E with B17F grounded. The delay may be monitored at B17M and adjusted accordingly.

The delay associated with the signal RECEIVE IN PROGRESS will have a time delay which is dependent upon the baud of the device. A table extracted from print D-BS-637-0-1 is as follows:

BAUD	PIN GROUNDED ON R303 at A16	DELAY (=1.5 times 1/Baud)
2000	L	0.75 MSec
2400	L	0.63 MSec
40,800	K	36.75 Usec

To set the delay, a program such as follows should have the pulse resulting from IOT 6X54 (where X is the first digit of the device code for the DP01A) at W103, A19S applied to A16T (R303) with A16U grounded. A16D may be monitored for the expiration of the one-shot delay and adjustment made accordingly.

A delay associated with "Receive Data" (discussed in DP01AA/Bell 201A3 Data Set Interface Problem, PDP-8 Field Service Tech Manual Section 5, Page 11) can likewise be set by applying a pulse from IOT 6X54 at W103-A19S to B17N with B17P grounded. Use the program which follows with appropriate TIME and COUNT values (use an initial delay in the neighborhood of 50 milliseconds or greater) and monitor the delay output at B17V and adjust accordingly.

It is absolutely essential that these delays be adjusted during installation or maintenance periods since marginal performance will result from misadjustment.

To use the following program to generate IOT's for setting delays, it is necessary to select values for TIME and COUNT from the table of constants which will give an interval of time between occurrences of the IOT great enough to allow the delay to time out. The interval selected initially should be greater than the suspected worst case setting of the delay.

Title DP01A SETTING DELAYS (Continued)						Tech Tip Number DP01-TT-3	
All Processor Applicability				Author		Rev	
B's				Approval B. Cummins		Date 7-31-72	
Cross Reference							

Table of Constants to be used for Appropriate Delays

Approx. Delay (ms)	5 β	26	6.5 β	2.4	.45	.1	.545
TIME	5 β 51	5 β 45	5 β 15 β	15 β 5 β	5 β 15 β	25 β 5 β	25 β 5 β
COUNT	65 β 5 β	615 β	745 β	745 β	7765 β	7765 β	7774

Program For Generating IOT's For Setting Delays

5 β 25 β	1225 β	TAD TIME	5 β 211	1216	TAD TIM
5 β 251	3216	DCA TIME	5 β 212	775 β	SMA
5 β 252	1221	TAD COUNT	5 β 213	525 β 2	JMP 25 β 2
5 β 253	3217	DCA COUNT	5 β 214	6X54	IOT @ w15 β 3 A19S
5 β 254	2217	ISZ COUNT	5 β 215	525 β 5	JMP 25 β 5
5 β 255	5254	JMP-1	5 β 216	2	TIME
5 β 256	1216	TAD TIME	5 β 217	2	COUNT
5 β 257	7554	RAL	5 β 225	XXXX	TIME
5 β 215	3216	DCA TIME	5 β 221	XXXX	COUNT

Interface to a Bell 201A3 is peculiar with respect to other 201's in that initial information being transmitted may be seen immediately (and illegally) on the receive line for several milliseconds. Because the first information transmitted is one or more sync codes, it is conceivable that these codes, when seen on the receive line, could cause the logic to become illegitimately active. Therefore, an interlocking delay is used to hold RECEIVE DATA in a marking or idle state during duplex operation until the danger of echoing data back to the receive logic has passed. This delay is set at 4.5 milliseconds. If, for example, the baud is 2000 and the word length has been selected to be 9 bits (4.5 milliseconds), it becomes necessary, because of the delay, to receive at least 3 sync codes during full duplex operation to ensure that the receive logic will become active.

Since this situation is peculiar only to on-line operations of the DP01(X)A/Bell 201A3, the delay should be removed, effectively, for all other modes of interface or operation (including 201A3 on-line tests) by attaching a ground to the R107 at A29M. If it is not bypassed during the use of Computer Special Systems Diagnostics Maindec 08-D8EB and Maindec 08-D8KA on-line tests, the receive logic will show a diagnostic error indicating that "X" number of syncs have been missed or that the logic plainly failed to go active.

A further note of caution - the delay should be set very close to 4.5 milliseconds and the customer informed of the necessity for using at least three (3) sync codes in his message formats.

digital	FIELD SERVICE TECHNICAL MANUAL				Option or Designator DP01
	12 Bit <input checked="" type="checkbox"/>	16 Bit <input type="checkbox"/>	18 Bit <input type="checkbox"/>	36 Bit <input type="checkbox"/>	

Title DP01 SETTING DELAYS (Continued)				Tech Tip Number DP01-TT-3	
Processor Applicability		Author	Rev		Cross Reference
All		Approval W. Cummins	Date 7-31-72		

A delay associated with "Receive Data" (this delay discussed following the sample program) can likewise be set by applying a pulse from IOT 6X54 at W103-A19S to B17N with B17P grounded. Use the program which follows with appropriate TIME and COUNT values (use an initial delay in the neighborhood of 50 milliseconds or greater) and monitor the delay output at B17V and adjust accordingly.

TABLE OF CONSTANTS TO BE USED FOR APPROPRIATE DELAYS

Approx. Delay (ms)	5 β	26	6. β	2.4	.45	.1	. β 45
TIME	$\beta\beta\beta 1$	$\beta\beta 4\beta$	$\beta 1\beta\beta$	1 $\beta\beta\beta$	$\beta 1\beta\beta$	2 $\beta\beta\beta$	2 $\beta\beta\beta$
COUNT	6 $\beta\beta\beta$	61 $\beta\beta$	74 $\beta\beta$	74 $\beta\beta$	776 β	776 β	7774

PROGRAM FOR GENERATING IOT'S FOR SETTING DELAYS

$\beta 2\beta\beta$	122 β	TAD TIME	$\beta 211$	1216	TAD TIME
$\beta 2\beta 1$	3216	DCA TME	$\beta 212$	77 $\beta\beta$	SMA
$\beta 2\beta 2$	1221	TAD COUNT	$\beta 213$	52 $\beta 2$	JMP 2 $\beta 2$
$\beta 2\beta 3$	3217	DCA CNT	$\beta 214$	6X54	IOT @ W1 $\beta 3$ A19S
$\beta 2\beta 4$	2217	ISZ CNT	$\beta 215$	52 $\beta\beta$	JMP 2 $\beta\beta$
$\beta 2\beta 5$	52 $\beta 4$	JMP-1	$\beta 216$	Z	TME
$\beta 2\beta 6$	1216	TAD TME	$\beta 217$	Z	CNT
$\beta 2\beta 7$	7 $\beta\beta 4$	RAL	$\beta 22\beta$	X $\beta\beta\beta$	TIME
$\beta 21\beta$	3216	DCA TME	$\beta 221$	X $\beta\beta\beta$	COUNT

Title DP01AA/BELL 201A3 DATA SET INTERFACE PROBLEM						Tech Tip Number DP01-TT-4		
All	Processor Applicability					Author Bill Cummins Rev 0		Cross Reference
	8	8I	8L			Approval Bill Cummins Date 7-31-72		

The complete option designation number for this device is DP01-XY where X indicates the computer family with which it is associated and Y indicates the basic model of data set to which it is interfaced.

X = A = 8 Family
 B = 9 Family
 C = 10 Family
 D = 7 Family

Y = A = Bell 201 or equivalent
 B = Bell 301 or equivalent
 C = Bell 303 or equivalent

Thus, the device designation with which we are most familiar is DP01-AA. The DP01(X)A may be interfaced to either the Bell 201A, 201B, or equivalent. Interface to a Bell 201A3 is peculiar with respect to other 201's in that initial information being transmitted may be seen immediately (and illegally) on the receive line for several milliseconds. Because the first information transmitted is one or more sync codes, it is conceivable that these codes, when seen on the receive line, could cause the receive logic to become illegitimately active. Therefore, an interlocking delay is used to hold RECEIVE DATA in a marking or idle state during duplex operation until the danger of echoing data back to the receive logic has passed. This delay is set at 4.5 milliseconds. If, for example, the baud is 2000 and the word length has been selected to be 9 bits (4.5 milliseconds), it becomes necessary, because of the delay, to receive at least 3 sync codes during full duplex operation to ensure that the receive logic will become active.

Since this situation is peculiar only to on-line operations of the DP01(X)A / Bell 201A3, the delay should be removed, effectively, for all other modes of interface or operation (including 201A3 on-line tests) by attaching a ground to the R107 at A29M. If it is not bypassed during the use of Computer Special Systems Diagnostics Maindec 08-D8EB and Maindec 08-D8KA on-line tests, the receive logic will show a diagnostic error indicating that "X" number of syncs have been missed or that the logic plainly failed to go active.

A further note of caution - the delay should be set very close to 4.5 milliseconds and the customer informed of the necessity for using at least three sync codes in his message formats.

Title DP01/OPTION DESIGNATION						Tech Tip Number DP01-TT-5		
All	Processor Applicability					Author Bill Cummins Rev 0		Cross Reference
	8	8I	8L			Approval Bill Cummins Date		

The complete option designation number for this device is DP01-XY where X indicates the computer family with which it is associated and Y indicates the basic model of data set to which it is interfaced.

X = A = 8 Family
 B = 9 Family
 C = 10 Family
 D = 7 Family

Y = A = Bell 201 or equivalent
 B = Bell 301 or equivalent
 C = Bell 303 or equivalent

Thus, the device designation with which we are most familiar is DP01-AA. The DP01 (X)A may be interfaced to either the Bell 201A, 201B or equivalent.

digital	FIELD SERVICE TECHNICAL MANUAL				Option or Designator DP01
	12 Bit <input checked="" type="checkbox"/>	16 Bit <input type="checkbox"/>	18 Bit <input type="checkbox"/>	36 Bit <input type="checkbox"/>	

Title DP01A DIAGNOSTICS			Tech Tip Number DP01-TT-6		
All	Processor Applicability		Author	Rev	Cross Reference
	8I	8	8I		
			Approval W. Cummins	Date 7-31-72	

When a synchronous modem, strapped for continuous carrier, is run in a local test mode with a DP01A, the following changes must be made to the on-line diagnostics;

Maindec-08-D8KA (Device Codes 60-67)

Loc	Change To	Comments
2410	5214	Eliminates looking for end flag with a constant carrier
2276	5350	Breaks main routine
2350	7200	
2351	6652	Makes certain that receiver shuts down when in constant carrier mode
2352	6651	
2353	5351	
2354	2367	
2355	5351	
2356	5277	Return to main routine
2367	0000	

Maindec-08-D8EB (Device Codes 30-37)

Loc	Change To	Comments
2410	5214	Eliminates looking for end flag with a constant carrier
2276	5350	Breaks main routine
2350	7200	
2351	6352	Makes certain that receiver shuts down when in constant carrier mode
2352	6351	
2353	5351	
2354	2367	
2355	5351	
2356	5277	Return to main routine
2367	0000	

COMPANY CONFIDENTIAL

Title DP01 " RECEIVE END FLAG"						Tech Tip Number DP01-TT- 7	
All Processor Applicability		Author W. Cummins		Rev 0		Cross Reference	
X		Approval W. Cummins		Date 7-31-72			

The DP01A is a synchronous communication channel and, as such, an uninterrupted chain of synch characters and/or data is necessary for transmission and receipt of meaningful data. Any interruption will cause a loss of information and a shift of all subsequent data.

Several means of determining data transmission accuracy are available. One possibility is the use of the Receive End Flag which will be set if, for any reason, the delay "DEL" times out and gives Receive In Progress. Since this delay is continually being reset by "Shift RB" it will never time out unless any one, or more, Receive Clock pulse(s) is not received from a modem.

Loss of a Receive Clock pulse will always cause an error in transmission; most customer programs do not use the Receive End Flag for monitoring the accuracy of the clock input. However, since the flag may come up, it may cause an interrupt which is not handled correctly by the customer's program. The customer should be made aware of the possibility of this flag problem. If he chooses to ignore it, and/or if he has other means of checking the accuracy of his data, the flag may be grounded out to prevent its interrupting his program. A jumper from A14T (R202) to ground may be used to eliminate the flag.

If the DP01 is interfaced to a data set operating in the constant carrier mode, the adjustable one-shot at A17 will not time out. This will eliminate the possibility of getting a "Receive End Flag" except as noted above since "Serial Clock Receive" should always be running.

Title DP01A External Component						Tech Tip Number DP01-TT- 8	
All Processor Applicability		Author W. Cummins		Rev 0		Cross Reference	
X		Approval W. Cummins		Date			

Print D-BS-637-0-1 (at B8) indicates a diode, resistor network to ground.

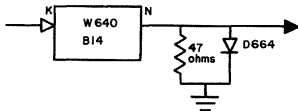

digital	FIELD SERVICE TECHNICAL MANUAL				Option or Designator
	12 Bit <input checked="" type="checkbox"/>	16 Bit <input type="checkbox"/>	18 Bit <input type="checkbox"/>	36 Bit <input type="checkbox"/>	DP#1 to DP12
Title DP01A EXTERNAL COMPONENT (Continued)					Tech Tip Number DP01-TT- 8
All	Processor Applicability	Author W. Cummins	Rev 0	Cross Reference	
8's		Approval W. Cummins	Date 07/31/72		

If the network has not been installed, random data errors can occur which will not be detected by the off-line diagnostics 08-D8HB, LA, FA or NA. If the diode has been installed with its polarity reversed, all data will be incorrect, shifted left some indefinite number of bits (one or more).

The on-line Maindocs 08-D8EB and KA may not detect the absence of these components but will fail if the polarity of the diode has been reversed upon installation.

Since no one of the diagnostics will positively detect the absence of this network, it should be verified during installation or maintenance that it has been installed as shown.

Title CONVERTING DP-12-A TO DP12B					Tech Tip Number DP12 -TT-1
All	Processor Applicability	Author	Rev 0	Cross Reference	
12		Approval H. Long	Date 8-17-72		

G718 Module	Slot N11	Remove
M405	Slot N11	Add
M216	Slot N12	Add

Crystal on M405 is for a frequency of XXX.X KHz which is 128 times the desired baud rate.

BC01A-XX cable to connect dataphone to the PDP-12

XX length of feet, from 5 to 50, 25 feet is a standard length

An M850 level converter card is connected to the end of the BC01A-XX cable to plug into slot N03

-- NOTES --

digital	FIELD SERVICE TECHNICAL MANUAL				Option or Designator
	12 Bit <input checked="" type="checkbox"/>	16 Bit <input type="checkbox"/>	18 Bit <input type="checkbox"/>	36 Bit <input type="checkbox"/>	DP-8E

Title		I.C. LOCATIONS		Tech Tip Number	DP-8E-TT-1
All	Processor Applicability			Author	B. Freeman
	8E			Rev	g
		Approval	W. Cummins	Date	8/7/73
					Cross Reference

In the shuffle of ECO's and relaying out of the M839 module used in the DP8E several I.C.'s may have different locations on the module than noted on the prints. Following is a list of the problems, ECO's and print showing the problems.

	ECO	Comment
M839	0001A	C.S. H is changed by replacing READ/WRITE F/F from RS type using E26 to CD type using E2. When relay out occurred this F/F became E15. Idle mode did not function properly. ECO added E26 to C input of T-GO F/F. Relay out used E31.
M839	0002	CS H adds CD type F/F to synchronize clear to send ECO calls out the use of E17 but relay out used E2.
M839	0005	CS L to correct a race condition a gate is added to SYNC 2 logic E26 is called for but because it is used in ECO 0001A E31 must be used in older boards.
M839	0001A	Add wire E2 pin 2 to E 3 Pin 6 ECO 0005, deletes all etch from E3 pin 6, if E3 pin 6 has a wire plus etch move the wire such that it runs from E2 to pin 2 to E11 pin 14.

COMPANY CONFIDENTIAL

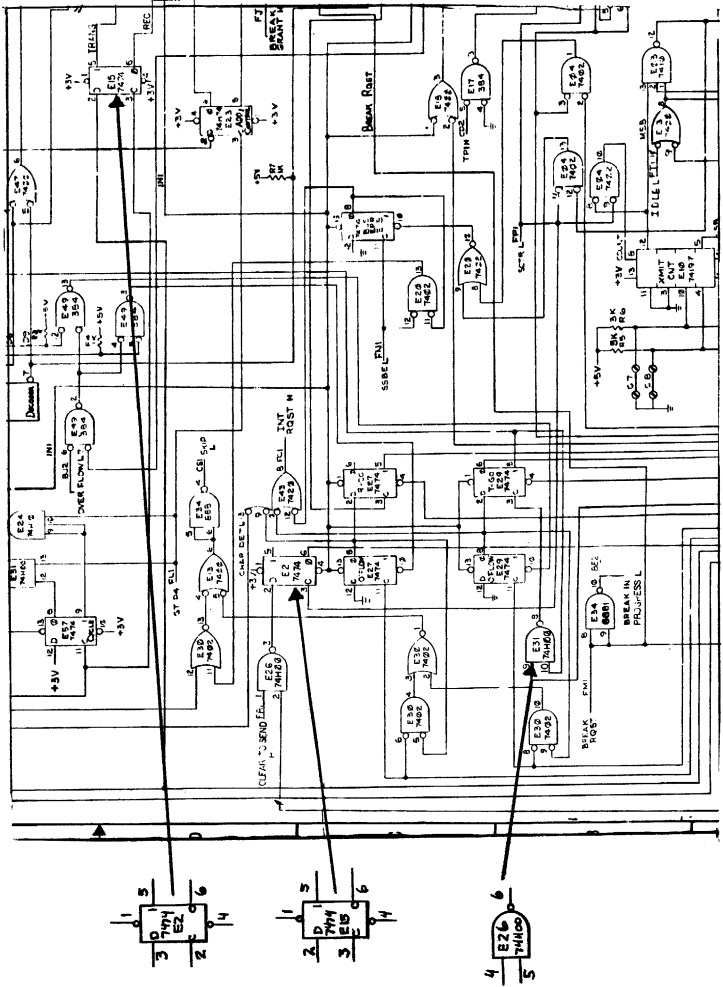

digital	FIELD SERVICE TECHNICAL MANUAL				Option or Designator
	12 Bit <input checked="" type="checkbox"/>	16 Bit <input type="checkbox"/>	18 Bit <input type="checkbox"/>	36 Bit <input type="checkbox"/>	DP-8E

Title		I.C. LOCATIONS		Tech Tip Number		DP-8E-TT-1	
All	Processor Applicability			Author	Rev		Cross Reference
	8E			B. Freeman	0		
Approval				Date			
W. Cummins				8/7/73			

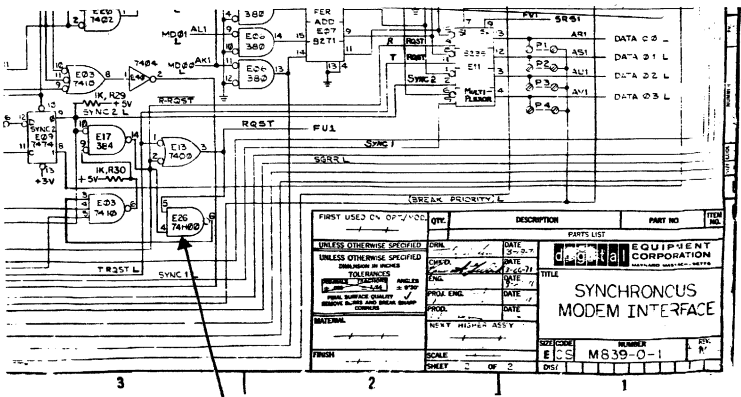

QTY.	DESCRIPTION	PART NO.	ITEM NO.
FIRST USED ON 07/1/00			
UNLESS OTHERWISE SPECIFIED			
QTY.	DATE	DIGITAL EQUIPMENT CORPORATION	
CHG'D.	DATE	CORPORATION	
ENL.	DATE	MILWAUKEE, WISCONSIN	
PROJ. ENL.	DATE	TITLE	
PROJ.	DATE	SYNCHRONOUS MODEM INTERFACE	
NEW Y. HELPER ASS'Y			
FINISH	SCALE	QTY. CODE	NUMBER
	1 OF 2	ECS	MB39-0-1

Title DP8E Jumpers						Tech Tip Number DP8E-TT-2		
All	Processor Applicability					Author W. Freeman	Rev β	Cross Reference
	8e	8m	8F			Approval W.E.Cummins	Date Oct. 17, 1973	

There seems to be some confusion in Jumpers listed in the DP8E prints the following is a chart correcting known errors and makes the jumpering clearer.

Module	Jumpers						
M839							
Bit/Character	B6	B7	B78	B8	B9	C7	C8
6	I	0	0	0	0	0	I
7	0	I	I	0	0	I	0
8	0	0	I	I	I	I	I
Break Priority Generate	P1	P2	P3	P4	P5	P6	P7
1	I	0	0	0	0	0	0
2	0	I	0	0	0	0	0
3	0	0	I	0	0	0	0
4	0	0	0	I	0	0	0
5	0	0	0	0	I	0	0
6	0	0	0	0	0	I	0
7	0	0	0	0	0	0	I
Access Address	A5	A6	A7				
7600	0	0	0				
7620	0	0	I				
7640	0	I	0				
7660	0	I	I				
7700	I	0	0				
7720	I	0	I				
Device Code	5	6	7	N5	N6	N7	
640X/641X	0	0	0	I	I	I	
642X/643X	0	0	I	I	I	0	
644X/645X	0	I	0	I	0	I	
646X/647X	0	I	I	I	0	0	
650X/651X	I	0	0	0	I	I	
652X/653X	I	0	I	0	I	0	
654X/655X	I	I	0	0	0	I	
656X/657X	I	I	I	0	0	0	

COMPANY CONFIDENTIAL

digital	FIELD SERVICE TECHNICAL MANUAL				Option or Designator
	12 Bit <input checked="" type="checkbox"/>	16 Bit <input type="checkbox"/>	18 Bit <input type="checkbox"/>	36 Bit <input type="checkbox"/>	DP8E to DS32

Title DP8E Jumpers				Tech Tip Number DP8E-TT-2	
All Processor Applicability			Author W. Freeman	Rev #	Cross Reference
8e	8m	8F	Approval W. E. Cummins	Date 10/17/73	

Character Recognition	2	4
0	I	0
2	0	I
4	I	I

Sync S4 S5 S6 S7 S8 S9 S10 S11

To select a bit a one the jumper should be in; for sync equal 226:

I 0 0 I 0 I I 0

M866 Jumpers

COIAGC		On	Off
Transition ON		I	0
OFF		0	I
ON & OFF		I	I
Duplex	Full duplex	HD	
	Half Duplex	0	
		I	

Modem Select	200 series	X	D
	301	I	I
	303	0	0
		I	I

Level Conversion	CE (2jumpers)	T (2 jumpers)	CT	E	C (6 jumpers)
EIA	I	0	0	I	0
Current	I	0	I	0	I
TTL	0	I	I	0	0

Clock Phase	Normal	N (2jumpers)	Δ (2 jumpers)
	Invertet	I	0
		0	I

The N, Δ jumpers on the left (next to I.C.E21) are transmit Clk.
 The N, Δ jumpers on the right (next to I.C. E12) are receive Clk.
 To run the diagnostic the transmit clock should be N the receive

Should be a Δ

COMPANY CONFIDENTIAL

Title DP 8E Jumpers						Tech Tip Number DP8E-TT-2			
All		Processor Applicability				Author W. Freeman		Rev g	Cross Reference
8e		8m		8f		Approval W. E. Cummins		Date 10/17/73	

Break Priority (Detect)

	P1	P2	P3	P4	P5	P6
1	0	0	0	0	0	0
2	I	0	0	0	0	0
3	I	I	0	0	0	0
4	I	I	I	0	0	0
5	I	I	I	I	0	0
6	I	I	I	I	I	0
7	I	I	I	I	I	I

Modem Timing

	ICL	L	F
Modem	0	0	0
External	0	I (output clk	I (output clk
Internal	I	I on cable	I on cable pin 11)

For diagnostic jumper F must be in, Jumper ICL not be in.
pin 24)

Spare Status Bits

(use with TTL configuration only)	Status 1	FF	JJ
Status 2	I		I

Do not have jumper L and Jumper FF both inserted

I = In
0 = Out

Title DF32-DS32 DISK DATA ERRORS						Tech Tip Number DS32-TT-1			
All		Processor Applicability				Author G. Chaisson		Rev 0	Cross Reference
8I		8L				Approval W. Cummins		Date 7-31-72	DF32-TT-4

digital	FIELD SERVICE TECHNICAL MANUAL				Option or Designator
	12 Bit <input checked="" type="checkbox"/>	16 Bit <input type="checkbox"/>	18 Bit <input type="checkbox"/>	36 Bit <input type="checkbox"/>	DS 300

Title MAINDECS AND THE DEC DATA SYSTEM 300				Tech Tip Number DS300-TT-1		
All	Processor Applicability			Author W. Freeman	Rev 0	Cross Reference
	8			Approval W. Cummins	Date 12/08/72	

The DEC DATA SYSTEM 300 is being sold without any means of paper tape input; thus to run any Maindec's the PMK02B Field Service cassette is required as input.

To connect the cassette remove the 2400 baud KL8E from the system and insert the cassette interface. Remove the BC01V cable from the VT05 and use the 7008519 cable which was shipped with the VT05 to connect the VT05 to the cassette. (Reference cassette instructions.) Switch the VT05 from 2400 baud to 110 baud. (Remember before leaving site to return the switch to 2400 baud.)

Run diagnostics according to existing procedures. The only need to reinsert the KL8E supplied with the system is to run the KL8E diagnostic, the VT05 diagnostic and customer software.

The DEC DATA SYSTEMS are delivered with a complete set of paper tape diagnostics. If the diagnostics on your cassette are incomplete or of the wrong revision, take the supplied paper tape to a system with paper tape input and make the necessary corrections to your cassette.

Title DS-300 System Configuration Change						Tech Tip DS 300-TT - 2 Number	
All	Processor Applicability					Author Bill Conners	Rev 0
	8E					Approval B. Lawrence	Date 2/8/74
							Cross Reference VRO-11-11 LK01R-TT-1

A new configuration for the DEC Data Systems will be manufactured starting January, 1974. The processor will be mounted in a short cabinet, facing forward, and a new desk design will be used. The purpose of this Tech Tip is to point out differences between the new systems and the older systems, and to clarify some points of confusion.

I. Initializers

A. Boards

All DDS 300 systems use the same G753 initializer board which plugs into slots C and D of the omnibus. Pressing the "initialize" switch asserts omnibus signals STOPL(DS2) and SWL(DV2), and releasing the switch negates the signals, starting the MI8-E bootstrap loader. See the schematic in Fig. 1.

B. Switches

Early DDS 300 systems had the power and initialize switches mounted in a power switch bracket (P/N 7409787) in the cabinet below the desk top. The systems used a G753 switch and cable assembly (7008 980), shown in Fig. 2. For the RK01 disks, a custom switch bezel assembly (P/N 7008948) contained the disk control and indicator cable, and was mounted on the top front of the short cabinet containing the disks.

digital	FIELD SERVICE TECHNICAL MANUAL				Option or Designator
	12 Bit <input checked="" type="checkbox"/>	16 Bit <input type="checkbox"/>	18 Bit <input type="checkbox"/>	36 Bit <input type="checkbox"/>	DS300

Title DS-300 System Configuration Change				Tech Tip DS 300-TT- 2		
All	Processor Applicability			Author Bill Conners	Rev 0	Cross Reference
	8E			Approval B. Lawrence	Date 2/8/74	

The current systems deleted the switch bezel assy and RK01 drives in favor of the RK05 disk drives, and moved the power and initialize switches to a shallow control pan (P/N 7409789) which was screwed to the underside of the desk. The G 753 switch and cable assy (7008980) was used for systems with DECTape, while a G754 switch and cable assy (7009136) (Fig. 3) was used for systems without DECTape. The new systems will have a new panel logo across the top front of the disk cabinet that will include the power and initialize switches and cables. The logo assembly (P/N 7009457) is shown in Fig. 4.

C. Cable Differences

The G753 cable assemblies have two extra wires in the harnesses that are not included in the G754 or 7009457 assemblies. The wires connect to "S1" of the H721 power supply, TB2-7 and -8, to include a normally-closed thermal circuit breaker inside the H721 in series with the power on-off switch. Should the heat sink containing the series regulator transistors and the thermal switch ever reach 95⁰ C, system power would be removed. The thermal circuit breaker will not be wired into the power on-off circuit of the new systems with DECTape. Should an H721 power supply on a new system overheat, it will affect only the DECTape logic power.

Title DS-300 System Configuration Change						Tech Tip Number DS 300-TT-2		
All	Processor Applicability					Author Bill Conners	Rev 0	Cross Reference VT05-TT-11 LK01R-TT-1
	8E					Approval B. Lawrence	Date 2/8/74	

II. VT05

A. IOT's

The console terminal for the DDS 300 systems is normally a VT05 operating at 150 send/2400 receive baud, full duplex, 64 character keyboard, device codes 03/04. The optional Foreground Background program which allows data entry from additional VT05s during main program execution assumes additional VT05s that are set up similarly, but with device codes 30/31, 32/33, 34/35, 36/37, 40/41, 42/43, and 44/45, in that order.

B. The KL8JA

Present systems use a KL8EG interface (M8650YA), connected to the EIA input of the VT05 through a 25 foot BC#1-V cable and an H308 null modem. The EIA connection is necessary because the KL8EG will not support a baud rate faster than 110 baud on its 20 ma output, due to a noise suppression network. The network is used on the 20 ma lines for Teletype operation to protect against high frequency noise, but it also limits the operating speed of the interface. New systems will be operating with a newly designed KL8JA interface (M8655),

digital	FIELD SERVICE TECHNICAL MANUAL				Option or Designator
	12 Bit <input checked="" type="checkbox"/>	16 Bit <input type="checkbox"/>	18 Bit <input type="checkbox"/>	36 Bit <input type="checkbox"/>	DS300

Title DS-300 System Configuration Change				Tech Tip Number DS-300-TT-2		
All	Processor Applicability			Author Bill Conners	Rev 0	Cross Reference VT05-TT-11 LK01R-TT-1
	8E			Approval B. Lawrence	Date 2/8/74	

connected through a P/N 7008360 Berg to Mate-N-Lok cable and a 25 foot P/N 7008159 TTY extension cable to the 20 ma input of the VT05. The noise suppression on the KL8JA's 20 ma output is jumper selectable, allowing use of the interfaces 20 ma output at any baud rate with the jumper removed.

The VT05 will still operate at 150/2400 baud; remote terminals can now be extended with 20ma connections to 1500 feet instead of the KL8E's maximum EIA cable length of 50 feet. The KL8JA also inserts from zero to four (Jumper-selectable) filler characters after a line feed, allowing printouts to be readable on the VT05 when diagnostics or other operating systems such as OS-8 are run on a Data System.

Since the KL8JA can communicate with the VT05 through either type of cable, while the KL8E must use the EIA and null modem, in emergency situations a KL8JA can be directly substituted for a KL8EG in a Data System. The necessary jumper changes to the KL8JA are included in Fig. 5. The KL8JA, however, is a more sophisticated, more expensive interface; it is not intended to be and should never be used as a permanent replacement for an existing KL8E, unless the customer wants to pay the upgrade cost.

C. Keyboards

The COS-300 monitor has a software implemented numeric keyboard feature that, after "Control N" is typed by the operator, allows the monitor to interpret the letter keys M, J, K, L, U, I, O, 7,8,9 as numbers 0, 1,

Title						Tech Tip	
Ds-300 System Configuration Change						Number DS 300-TT-2	
Processor Applicability						Author Bill Connors Rev 0	
All		8E		Approval B. Lawrence		Date 2/8/74	
						Cross Reference	
						VT05-TT-11	
						LK01R-TT-1	

2, 3, 4, 5, 6, 7, 8, 9. Typing "Control N" again returns the monitor to normal keyboard interpretation. A set of ten (10) light grey key caps are shipped with each DDS-300 VT05 to highlight the keypad feature, and are pressed onto the keyboard keys after the original key caps have been removed.

NOTE: THE KEYBOARD IS NOT ELECTRICALLY MODIFIED!

Only the keycaps are changed.

The new LK01-R mechanical keyboard (P/N 54-10541-0-1) cannot directly replace the existing Rev E and Rev F variable capacitance keyboards (P/N 54-09945) unless the variable capacitance cursor control (P/N 30-10166-0-1) is also replaced with the mechanical version (P/N 54-10613-0-1).

Also, the light grey key caps for the variable capacitance keyboards (P/N 90-09148-0-74 for a set of ten) will not fit on the LK01R mechanical keyboards.

If an LK01-R keyboard is used to replace a variable capacitance keyboard, the optional set of light grey key caps for the LK01R will have to be ordered. Reference future tech tip LK01R-TT-1 for a discussion of the two keyboards and a list of part numbers.

- D. The $\frac{1}{4}$ x 20 x $\frac{3}{8}$ " nylon screws used as feet for the VT05 are too short to reach the recessed threads in the new plastic base castings. The specification for the screw has been changed, and in the future if you order screws using the original part number (12-10582), you will receive the new longer size ($\frac{1}{4}$ x 20 x $\frac{3}{4}$ ").

Title Ds-300 System Configuration Change					Tech Tip Number Ds 300-TT-2		
All	Processor Applicability				Author Bill Conners	Rev 0	Cross Reference VT05-TT11 LK01R-TT-1
	8E				Approval B. Lawrence	Date 2/8/74	

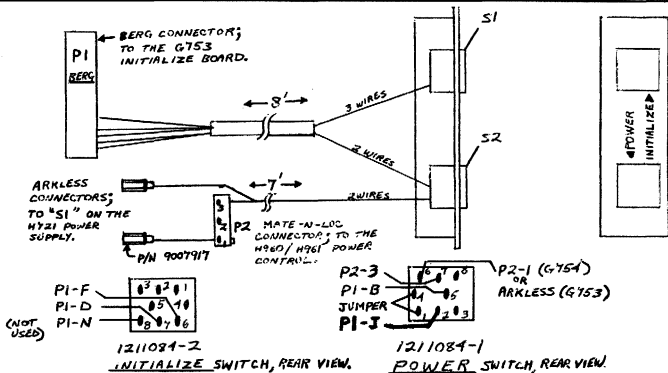

FIG. 2

G753 Switch and Cable Assembly (P/N 7008980)
(for Systems with Dectape)

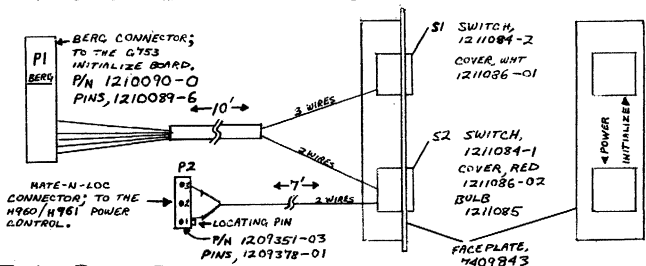
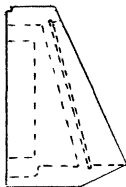
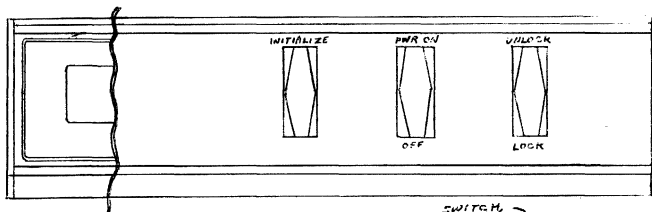

FIG. 3

G754 Switch and Cable Assembly (P/N 7009136)
(for Systems Without Dectape)

digital	FIELD SERVICE TECHNICAL MANUAL				Option or Designator
	12 Bit <input checked="" type="checkbox"/>	16 Bit <input type="checkbox"/>	18 Bit <input type="checkbox"/>	36 Bit <input type="checkbox"/>	DS300
Title DS-300 System Configuration Change					Tech Tip Number DS-300 TT-2
All Processor Applicability		Author Bill Conners	Rev 0	Cross Reference VT05 TT-11	
SE		Approval B. Lawrence	Date 2/8/74	LK01R TT-1	



WHITE PLASTIC
ROCKER FOR
ALL 3 SWITCHES
P/N 1205317-6

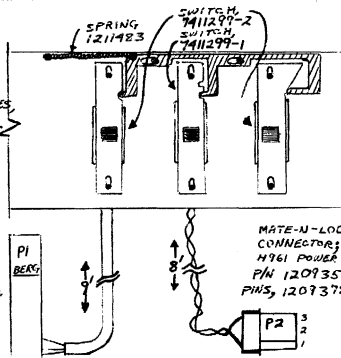

BERG CONNECTOR,
TO G753
INITIALIZE BOARD.
P/N 1210918-15
SOCKETS 1210089-6

MATE-N-LOC
CONNECTOR; TO THE
M961 POWER CONTROL.
P/N 1209351-3
PINS, 1209378-1

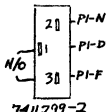

7411299-2
INITIALIZE,
REAR VIEW.

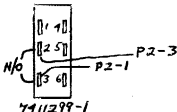

7411299-1
POWER SWITCH,
REAR VIEW.

New Ds 300 Switch Assembly (P/N 7009457)

FIG. 4

Title DS-300 System Configuration Change				Tech Tip Number DS-300-TT-2		
All	Processor Applicability			Author Bill Conners	Rev 0	Cross Reference VT05 TT-11 KL8JR TT-1 KL8JR TT-2
	BE			Approval B. Lawrence	Date 2/8/74	

Switches

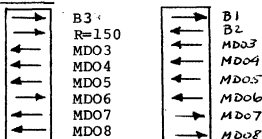

"Transmit"

"Receive"

Arrows indicate depressed switches; \rightarrow = on, \leftarrow ϕ = off. For the example shown, device codes are 03/04, speed is 150 baud receive/2400 baud transmit.

JUMPERS (as normally shipped for DS-300)

R = 150

Name	Pos.	Use
W1/TTY	out(2)	Disable TTY filter
W2	in	Must be in!
W3/SWD	in(1)	Enable status word
W4/SB	in(2)	One stop bit
W5	out	Must be out!
NP	out	No parity
EVN	out	Odd parity (when NP-in)
NBI	out	8 bits per character
NB2	out	8 bits per character
FIL	in(1)	Enable 4 filler characters

Off - xmit and RCv speeds are the same.

On - xmit speed set by B1, B2, B3; RCv speed = 150.

B1	B2	B3	Baud Rate
0	0	0	110
0	0	1	150
0	1	0	300
0	1	1	600
1	0	0	1200
1	0	1	2400
1	1	0	4800
1	1	1	9600

- The "SWD" and "FIL" jumpers should be OUT for the KL8JA to emulate a KL8EG.
- The "TTY" jumper should be IN and the "SB" jumper OUT for 110 baud teletype operation.

KL8-JA Jumper Configuration

FIG. 5

digital	FIELD SERVICE TECHNICAL MANUAL				Option or Designator DT01
	12 Bit <input checked="" type="checkbox"/>	16 Bit <input type="checkbox"/>	18 Bit <input type="checkbox"/>	36 Bit <input type="checkbox"/>	

Title DT01 - PDP-8/E				Tech Tip DT01 TT-1 Number		
All	Processor Applicability			Author Bill Freeman	Rev 0	Cross Reference PDP-8/E TT# 002
	8E			Approval W.E. Cummins	Date 7-31-72	

When using a DT01 Bus switch on a PDP-8E, it is necessary to change the W103 to W123 as noted in PDP-8/E TT #002 and also change the outputs of the W640 in B6 from 400 nsec, to 1 usec. To utilize 1 usec outputs add wire on location B6 - E to F, L to M, and S to T.

Title INTERMITTENT BREAK FAILURE ON DT01AN				Tech Tip Number DT01-TT-2		
All	Processor Applicability			Author Roney/Nunley	Rev	Cross Reference
	8			Approval W. Cummins	Date 6/6/72	

Erratic Break Operation

The use of a 552 or TC01 with a DT01-AN may cause erratic break operation to one or both computers. The reason is that, unlike the DM01, DF32, and RF08, the break request signal is not clamped at the source. To cure the erratic operation, clamp the signal C-BRK REQ in the DT01 to -3V. Add B31J to B26S.

C.E. Roney/R. Nunley - October 1970

-- NOTES --

digital	FIELD SERVICE TECHNICAL MANUAL				Option or Designator
	12 Bit <input checked="" type="checkbox"/>	16 Bit <input checked="" type="checkbox"/>	18 Bit <input checked="" type="checkbox"/>	36 Bit <input checked="" type="checkbox"/>	EDC Voltage Standard

Title Voltage Source and Voltage Measurements with the EDC Voltage Standard				Tech Tip EDC-TT-1 Number	
All	Processor Applicability			Author George Chaisson	Rev 0
X				Approval Bill Cummins	Date 06/01/72
					Cross Reference

The following procedure is written for the following models of the EDC voltage standard; VS-11N, VS-11G, MV-100G and MV-105G.

1.0 As A Voltage Source

The EDC can provide an accurate voltage between 0 and + 11.111 volts. This is accomplished by selecting the appropriate voltage from the decade switches and connecting via the output binding post. Polarity is selected via the +0- selecting switch. (On the 100 and 105 models, a low level output is polarity controlled via the +0- switch also.)

2.0 As A Voltage Measuring Device

The EDC can be used to measure DC voltages with very high accuracy. For voltages between 0 and + 10 volts, the voltage is connected directly to the input binding post labeled "UNKNOWN". (For voltages between 10 and 100 volts use 10:1 divider, DEC part Number 29-16810). Selection of the correct polarity is accomplished with the +0- switch; when the correct polarity is selected the NULL meter will deflect and the decade switches will control zeroing. (In the 105 model the meter sensitivity selector must be in one of the voltage positions.) Zero the meter by increasing the voltage value from the decade switches. This will be the first step in making an accurate measurement.

When the meter has deflected just beyond zero with the lowest voltage step from the decade switches, reset this switch by one count. Select a higher meter sensitivity by depressing the sensitivity bat switch (model 105, sensitivity rotary switch: The model 100 has three sensitivities, the bottom position of the bat switch being 100 μ V F.S.) and again increase the voltage from the decade switches until NULL (zero) on the meter is reached. The voltage measured is now the value read directly from the decade switches. (If the 10:1 divider 29-16810 has been used, multiply the value by 10.)

Non-Standard Controls: On some models of the EDC there is a meter zero switch and adjustment knob. The switch is located at the lower left of the meter and the adjustment knob is at the upper right of the meter. When the switch is down, zeroing position, the zeroing knob will allow electrical zeroing of the measuring circuit. This switch must be in the up position for measuring. (It is recommended that the instrument be zeroed before measurements are made.)

Model 105 instruments have a selection switch (volts-millivolts) that must be in the volts position.

Title					VOLTAGE SOURCE AND VOLTAGE MEASUREMENTS WITH THE EDC VOLTAGE STANDARD (Continued)					Tech Tip Number EDC-TT-1									
All					Processor Applicability					Author George Chaisson Rev 0					Cross Reference				
X										Approval Bill Cummins Date 06/01/72									

For PDP-11 use - VS-11N or MV-100G standards are used in the set-up of AD01-D, AAll, AFC 11 and UDC 11.

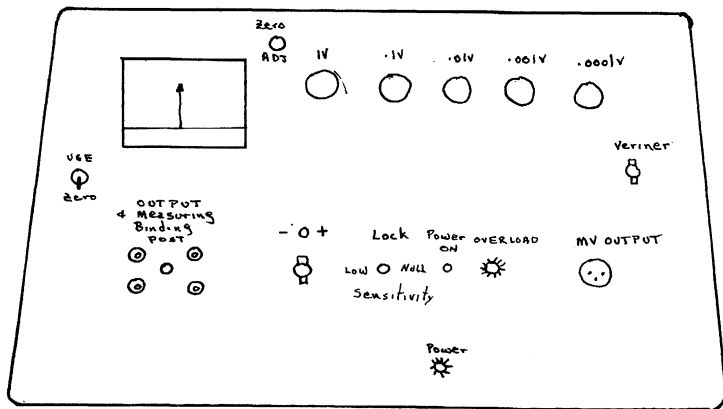

Typical EDC Front Panel

digital	FIELD SERVICE TECHNICAL MANUAL				Option or Designator
	12 Bit <input checked="" type="checkbox"/>	16 Bit <input type="checkbox"/>	18 Bit <input type="checkbox"/>	36 Bit <input type="checkbox"/>	EDUSYSTEMS

Title EDUSYSTEM SR SETTINGS				Tech Tip Number EDUSYS-TT-1		
All	Processor Applicability			Author W. Cummins	Rev 0	Cross Reference
				Approval D. Dubay	Date 07/27/72	

EDUSYSTEM MANUALS (as they exist as of this date) fail to give the switch register settings to select the input device at bootstrap time.

EDUSYSTEM: 5 & 10 manuals being rewritten - information to be included.
 20 will get errata sheet
 25 has new manual and is now okay.
 30 & 40 has one addendum, will receive a second.

The new book, EduSystems Handbook, available in the fall, will have this information.

The settings to select the input device are:

5356 Paper Tape Reader
 0600 DECTape
 5350 Disk

Title EDUSYSTEM WITH POWER FAIL&HARDWARE BOOTSTRAP LOADER						Tech Tip Number EDUSYS-TT-2	
Processor Applicability			Author <u>Ray Alvarez</u>		Rev <u>g</u>		Cross Reference
All	12	'		Approval <u>F. Purcell</u>	Date <u>2/5/74</u>		

The Problem: Systems incorporating both powerfail and the hardware bootstrap loader options inter-act when the system is powered down and then up again, with the switch-switch in the down position (ON). With the switch-switch in the down position (ON) memory locations are altered by each option that tries to use the bus to deposit their respective programs into memory. When the switch-switch is on and power comes up it reactivates without being toggled. This could cause the need for a momentary switch to insure return to the off position.

Correction: If service calls are frequent due to operators inability to check switch positions; replace switch-switch with a momentary switch.
Dec. Part #12-05375

digital	FIELD SERVICE TECHNICAL MANUAL				Option or Designator
	12 Bit <input checked="" type="checkbox"/>	16 Bit <input type="checkbox"/>	18 Bit <input type="checkbox"/>	36 Bit <input type="checkbox"/>	EM12 to EP12

Title					TIMING CHANGE FOR DMØ1 CONFIGURATIONS		Tech Tip Number	EM12-TT-Ø1
All	Processor Applicability				Author	H. LONG	Rev	Cross Reference
12					Approval	H. LONG	Date 7/20/72	

Single cycle data break devices together with a DMØ1 will not operate correctly on a PDP-12 (there is not enough setup time for the field bits).

Change break sync timing from CPTP TP5S to CPTP TP3:

RUN	ADD	DEL
HØ9H2 - J1ØP1		X
J1ØP1 - JØ4K1		X
HØ9H2 - JØ4K1	X	
JØ4P1 - J1ØP1	X	
J21D2 - H34K1		X
J21D2 - JØ9E1	X	
KØ4K1 - JØ9H1		X
KØ4K1 - L38B1		X
L38B1 - JØ9H1	X	
KØ4K1 - JØ6D2	X	

COMPANY CONFIDENTIAL

Title						Tech Tip	
ECO EP12- 0003						Number	
						EP12-TT-1	
All	Processor Applicability					Author	Rev
						H. Long	0
					Approval	Date	Cross Reference
12						08/17/72	

The problem: Solution portion of this ECO, and its associated DEC-ECO-LOG Synopsis, would seem to indicate that an M112 module must be deleted, and an M113 and M617 added. This is not the intent of the ECO.

Logically, the M112 is deleted, and the M113-M617 combination added to increase the drive on MXB MEM TP3 H. These modules are already present in the MCL2 portion of the processor; we only delete and add individual gates.

Title						Tech Tip	
Display/Data Break Interaction						Number	
						EP12-TT-2	
All	Processor Applicability					Author	Rev
						Harold Long	
					Approval	Date	Cross Reference
					Harold Long	9/26/72	

PROBLEM:

ECO EP12-00033 allows an external break request to abort a display instruction. This causes unreadable display at high data rates.

CORRECTION:

Implement a new instruction: Skip on display busy (0446). This will allow the processor to delay initiating a DSC until the previous instruction is complete. NEMONIC: DSB.

MAKE ALL DELETIONS FIRST WHEN INSTALLING

<u>SIGNAL NAME</u>	<u>FROM PIN</u>	<u>TO PIN</u>	<u>ADD</u>
SKL I SENSE	M04K1	H32H2	X
INS N EQ 6H	M04L1	J40H2	X
DSC BUSY H	M04M1	L02U1	X
+3V L03U1	M04L2	M04M2	X
+3V L03U1	M04U1	M04V1	X
+3V L03U1	M04M2	M04U1	X
+3V L03U1	L03U2	M04V1	X

PAGE	238	PAGE REVISION	A	PUBLICATION DATE	November 1972
------	-----	---------------	---	------------------	---------------

COMPANY CONFIDENTIAL

digital	FIELD SERVICE TECHNICAL MANUAL				Option or Designator
	12 Bit <input checked="" type="checkbox"/>	16 Bit <input type="checkbox"/>	18 Bit <input type="checkbox"/>	36 Bit <input type="checkbox"/>	EP12 to FPP12

Title Display/Data Break Interaction (Continued)				Tech Tip Number EP12-TT-2		
All	Processor Applicability			Author Harold Long	Rev 0	Cross Reference
	12			Approval Harold Long	Date 9/26/72	

NOTE:

This tech tip implements a new instruction which is not supported by system software. Customers desiring to use this instruction must define it in their symbol table: DSB=#446.

Thus, the following sequence would permit efficient use of display instructions during data break.

```

DSC X /DISPLAY 1/2 CHAR.
DSB I /SICIP ON DISPLAY NOT BUSY
JMP . -1 /WAIT
DSC I X /DISPLAY 1/2 CHAR

```

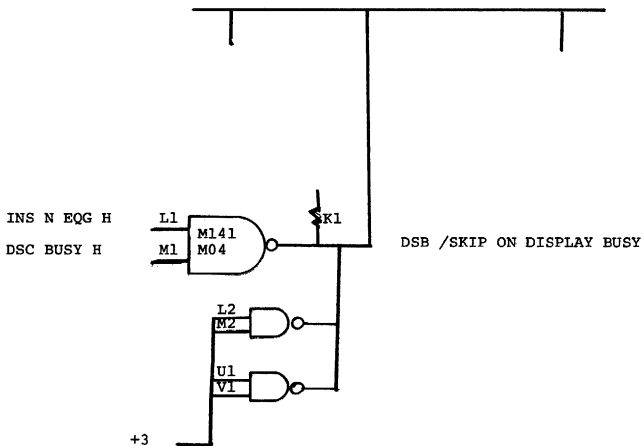

SKL I SENSE L

Title FPP12 PROBLEMS						Tech Tip Number FPP12-TT-1		
All	Processor Applicability					Author	Rev 0	Cross Reference
	12					Approval H. Long	Date 09/14/72	

- The +5V to logic rack is not tied together at FPP. Due to age and other conditions affecting the pins on the Mate-in-Lock connector at the H721 power supply, the +5V may be at different levels on logic rows A thru J. Connect the +5V buses together with #14-18 wire at the rack H911 mounting panel connections.
- The M401 clock modules is unstable in some cases. The frequency changes by a large amount around the desired 5 MHZ setting. Their variance may cause random and differnet FPP errors that are virtually impossible to track down. Some of these M401 vary as soon as power is applied, others may have to run awhile.

To tell if an M401 is unstable put an "0" scope type 453 or equivalent on the clock output. With about 8-12 pulses displayed look for a sudden shifting of the pulses in time. If this doesn't help them replace the M401 and tag it as unstable frequency output.

- The FPP 12-00007 ECO contains a wiring error. On oage 7 of 60 an add-delete page:

Signal	From	TO	Add	Del
SP12 XCT4 SHFT H A24D1		A22D1		X
SHOULD BE				
SP12 XCT4 SHFT H A24D1		A22D2		X

Pin A22D1 is not connected to A24D1 and is in the wire run SP11 ENABLE PROCESS L.

COMPANY CONFIDENTIAL

PAGE 240	PAGE REVISION 0	PUBLICATION DATE September 1972
----------	-----------------	---------------------------------

digital	FIELD SERVICE TECHNICAL MANUAL				Option or Designator G020 - G021
	12 Bit <input checked="" type="checkbox"/>	16 Bit <input type="checkbox"/>	18 Bit <input type="checkbox"/>	36 Bit <input type="checkbox"/>	

Title SENSE AMP REVISIONS				Tech Tip Number G020-21 TT#1	
All Processor Applicability		Author A. Newbury	Rev 0	Cross Reference	
8I	8L	Approval W. Cummins	Date 7-31-72		

8I/L sense amps now use a -4V slice level instead of -3V for increased noise immunity. Either level works fine as long as they are not intermixed. When replacing a G020 or G021 check for the proper level, or when a ghostly symptom occurs in memory check for this mix up. There are a few different revisions of sense amps but the following few rules should eliminate the confusion:

- 1) Rev. D and earlier are considered -3V slice level.
- 2) Rev. F and later are considered -4V slice level.
- 3) Rev. E can be either -3V or -4V and it is the only revision that can be changed. The resistors to change are listed below:

	R6	R5	R12	R11
-3V slice level	300	330	330	300
-4V slice level	330	180	180	330

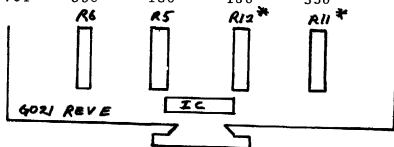

* Denotes components present only on G021. G020 uses G021 etch.

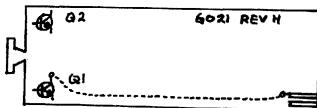

(eyelet leading from pin T1)

(eyelet connected to collector of Q1)

COMPANY CONFIDENTIAL

Title						Tech Tip	
SENSE AMP REVISIONS (CONT.)						Number G020-21-TT-1	
All Processor Applicability						Author A. Newbury Rev 0	
8I 8L						Approval W. Cummins Date 7-31-72	
Cross Reference							

Rev. H sense amps should have a 30 gauge ground strap as shown above. This ground strap insures proper strobe margins and noise immunity.

Random 8I Memory Failures:

If you have intermittent memory problems or you do not have a wide strobe margin, check for these things:

1. That -3V and -4V sense amps are not intermixed in an 8K unit.
2. That Rev. H sense amps have the ground strap.
3. That G221 selectors have 2904 transistors. If the 2904 transistors are Texas Instrument, check that the fall time is within specification (10-90 nsec.).
4. That G624 load resistors are all the same value in any 8K unit, and that for Ferroxcube stacks they are all 56 ohm. Previous values have been 60, 70 or 52.5 ohms. 52.5 is not acceptable under any conditions.
5. That memory current has been adjusted with a current probe and strobe has a good window between checkerboard failures and strobe adjustment. Measuring voltage does not insure proper current values for memory.
6. That ECO 8I-00022 is installed. Although this ECO was directed to the field, it has been instrumental in fixing problems in several older machines. The SPECO does not explain too clearly the add/delete scheme. You will see that the first two deletes are A30D2 to A34S2 and A30E2 to A34T2. The essence of the problem is that those two leads carry the sense signal and may not be identical in length or routing and may trigger the sense amps erroneously because of the noise or phase discrepancy; the two deletes are to be replaced by one run on twisted pair. The other deletes are similarly paired; each pair is to be replaced by one run on twisted pair. The other deletes are similarly paired; each pair is to be replaced by one run of twisted pair.
7. If instruction test 1 will not run in field 1 of a system with 8K or more of memory, it may be a result of induced noise picked up from the memory power supply lines by the memory flip-flop output lines. ECO 8I-00051 reroutes these runs to eliminate this problem.

Title						Tech Tip	
ADJUSTMENT OF G084 in TU20						Number G084-TT-1	
All Processor Applicability						Author Rev 0	
8's						Approval W. Cummins Date 06/06/72	
Cross Reference							
CPL TU20-TT-4							

-- NOTES --

-- NOTES --

digital	FIELD SERVICE TECHNICAL MANUAL				Option or Designator
	12 Bit <input checked="" type="checkbox"/>	16 Bit <input type="checkbox"/>	18 Bit <input type="checkbox"/>	36 Bit <input type="checkbox"/>	G221

Title				DOUBLE SELECTION OF G221		Tech Tip Number		G221 TT#1	
All	Processor Applicability				Author	R. Rasmussen		Rev	0
	8I	8L			Approval	W. B. CUMMINS		Date	11/14/73
							Cross Reference		

Failures of G221's are hard to find barring mass swap. What happens is that two or more outputs come on at the same time causing selection of two addresses. This causes errors in address test but the failure is not diagnosable. Swapping boards within system doesn't change the problem. A method to find the bad G221 is: (for 8I corresponding points may be used for 8L).

- 1) Remove M360 strobe board found slot B23. Tape pin S2 of board. Gnd pin S2 of B23. Reinstall M360.
- 2) Remove G020/021 from slots A31 and A32. Gnd pin U2 of A32. * Note when load address and start are depressed a 7000 code is decoded as nop. This keeps computer in fetch and will cause PC & MA to increment sequentially.
- 3) Sync scope negative channel A internal. Put Channel A on E2 of C38 (MA00 (1)). Adjust time base with adjustable uncalibrate mode till you have 1 cycle covering 8 cm. on scope.
- 4) With channel B scope outputs of G221's on connector board C36. Starting with pin C2. This signal should look like Figure 1. The signal on channel B should be 1 cm wide and should step 1 cm by changing channel B probe from C36 D2 to E2, F2 to H2, J2 to K2, L2 to M2, N2 to P2, R2 to S2, T2 to U2. Signals are push-pull pairs, one positive, the other negative; i.e., C2 and D2, E2 and F2, etc.
- 5) Move channel A probe to D33 E2 and sync on MA03 (1). Readjust time base for one cycle in 8 cm. Repeat step 4 scoping pins C2 to U2 on connector D34.
- 6) Move channel A probe to C33 E2 and sync on MA06 (1). Readjust time base for one cycle in 8 cm. Repeat step 4 scoping pins C2 to U2 on connector C34.
- 7) Move channel A probe to D38 E2 and sync on MA09 (1). Readjust time base for one cycle in 8 cm. Repeat step 5 scoping pins C2 to U2 on connector D36.
- 8) Figure 1 is how set up should look.
- 9) Figure 2 is how some bad G221's look.

COMPANY CONFIDENTIAL

Title						DOUBLE SELECTION OF G221 (cont.)		Tech Tip	
Processor Applicability						Author		Rev	
All						P. Rasmussen		g	
8I		8L				Approval		Date	
						W. E. Cummins		11/15/73	
						Cross Reference			
						G221 TT#1			

FIGURE 1

Channel A
MAXX (1)

Channel B
R/W Driver (G221)

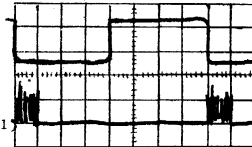

Signals will be either positive or negative spikes depending on point selected

FIGURE 2

Channel A
MAXX (1)

Channel B
R/W Driver
(G221)

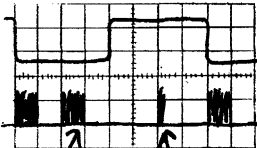

Bad diode in matrix or bad G221

Bad (G221) extra block of pulses

COMPANY CONFIDENTIAL

digital	FIELD SERVICE TECHNICAL MANUAL				Option or Designator
	12 Bit <input type="checkbox"/>	16 Bit <input checked="" type="checkbox"/>	18 Bit <input checked="" type="checkbox"/>	36 Bit <input type="checkbox"/>	G-231

Title INHIBIT CURRENT JUMPERS				Tech Tip Number G-231-TT-1		
All	Processor Applicability			Author. C. Alger	Rev 0	Cross Reference
	11	15		Approval Bill Dimbat	Date 1/2/74	

Under no circumstances should the jumper arrangement for the current setting be changed.

They are factory set to give optimum performance for the overall temperature range. By changing these jumpers you might improve margins at room temperature but you degregeate the total system performance.

-- NOTES --

digital	FIELD SERVICE TECHNICAL MANUAL				Option or Designator
	12 Bit <input checked="" type="checkbox"/>	16 Bit <input type="checkbox"/>	18 Bit <input type="checkbox"/>	36 Bit <input type="checkbox"/>	G826

Title				Tech Tip		
G826 ADJUSTMENTS				Number		
				G826-TT-1		
All	Processor Applicability			Author	Rev	Cross Reference
	8I	8L		Approval W. Cummins	Date 7-31-72	

Many G826's are returned from the field as defective when, actually, there is no defect, only misadjustment of POWER OK.

The basic operational functions of the G826 are first, to detect the AC power input going low and second, to regulate the memory voltage level. The detection of power-in going low, due to either line failure or the front panel power switch being set to the OFF position, is accomplished by sampling for variations on the 5 volt bus. When the 5 volt bus drops below 4.75 volts, the condition is felt by an operational amplifier which generates POWER OK as a +3 volt level. This level becomes the conditioning level which allows the next TP3 to clear the RUN flip flop. At the same time, a turn off signal is applied to the -30 volt memory supply. These two logical events occur to disallow a random read without its associated write cycle. When POWER OK is at +3 volts, the RUN flip flop will act as if the SINGLE STEP switch were on and -30 volts will not come up.

The memory voltage level is set by a pot which is in parallel with an amplifier between the -6 volt and -30 volt supplies. In normal operation, POWER OK is low (0 volts). With a scope sampling at A02J2 (of the 8I) or the negative probe of a meter on that point, with the positive probe to ground, adjust the halipot, in the center of the module, clockwise until POWER OK just goes low (0 volts), then a few degrees more.

With POWER OK low, memory voltage may now be adjusted; set up meter connections as follows:

	METER LEADS	
	NEGATIVE	POSITIVE
8I	B02V2	B02M2
8L	B27V2	B27M2

Adjust the Bourns pot on the edge of the module for a reading of +21 to +22.5 volts.

PDP 8L's, logic serial #150 and later, have a power supply connector card, G785 revision "D" or later, which will make the POWER OK adjustment less critical. They have an extra detection circuit which is OR'ed with the output of the differential amplifier at pin AJ2 which stops the CP before the +5 volt line begins to drop.

COMPANY CONFIDENTIAL

Title G826 ADJUSTMENTS (Continued)						Tech Tip Number G826-TT-1				
All	Processor Applicability					Author		Rev		Cross Reference
	8I	8I				Approval W, Cummins		Date 7-31-72		

After these adjustments have been made, Maindec 08-DIAB, Memory Power ON/OFF Test, should be run. The helipot is mechanically sensitive; after adjustment, a spot of nail polish or paint should be applied to the adjustment stem to secure it in the desired position.

COMPANY CONFIDENTIAL

digital	FIELD SERVICE TECHNICAL MANUAL				Option or Designator
	12 Bit <input checked="" type="checkbox"/>	16 Bit <input checked="" type="checkbox"/>	18 Bit <input checked="" type="checkbox"/>	36 Bit <input checked="" type="checkbox"/>	G848 to GLC8

Title G848 ECO HISTORY AND NOTES				Tech Tip Number	G848-TT-1
All	Processor Applicability		Author Jeff Blundell	Rev A	Cross Reference
X			Approval Frank Purcell	Date 11/1/73	TU56-TT-10

ECO	CS	ETCH	DESCRIPTION
1	A	B	Deleted a diode and transistor
2	B	C	Deletes many components and layout
3	C	C	Adds plastic insulating caps over transistors
4			} ECO's must be done together, all modules in drive be done together (no mixing old and new) High priority MANDATORY change. 4 and 5 prerequisites.
5	E	K	
6			
7	H		ECO 725-008 goes with this. Cuts etch between AC2 and BC2.
8	J	M	New triple size board created.
8A			Retrofit to double size boards to make them compatible with the new triple size board.

VARIOUS INCOMPATIBILITIES AND RESTRICTIONS

1. Etch B will not work with the new wiring harness unless mate-n-lock pins 1 and 3 are jumpered.
2. ECO's 4,5 and 6 must be installed in all TU56 everywhere, and all spare boards modified. Modules without these ECO's must not be mixed with any other revision except their own.
3. The new triple height module created by ECO 8 must not be used in the same transport with an old double height module, unless the old module has had ECO G848-008A (and the earlier ECO's) installed.
4. ECO #725-008 is a prerequisite for the new triple height board.

COMPANY CONFIDENTIAL

Title GLC-8 INPUT AMPLIFIER						Tech Tip Number GLC8-TT-1	
All Processor Applicability			Author Jim Lacey		Rev g		Cross Reference
8			Approval Bill Freeman		Date 12/05/73		

GLC-8 Input Amplifier

If any of the below malfunctions occur with the A211 module, it is probably due to C4 and/or C5, which are 0.0047 mfd 1% capacitors (10-09312), being out of tolerance. Replacing both of these capacitors should cure the problem. However, if difficulty is encountered when readjusting the A211, a 10 to 56 pf capacitor may be added to the circuit as C3. This capacitor would be mounted on the circuit board in the holes provided at the handle end of the module.

Possible malfunctions include:

1. Inability to adjust the gain.
2. Inability to adjust the line balance (this adjustment interacts with the gain adjustment).
3. Excessive noise.

COMPANY CONFIDENTIAL

PAGE 252	PAGE REVISION g	PUBLICATION DATE Jan. 1974
----------	-----------------	----------------------------

digital	FIELD SERVICE TECHNICAL MANUAL				Option or Designator
	12 Bit <input checked="" type="checkbox"/>	16 Bit <input type="checkbox"/>	18 Bit <input type="checkbox"/>	36 Bit <input type="checkbox"/>	H307 to H710

Title				Insufficient Low End of Delay		Tech Tip Number		H307-TT-1		
All	Processor Applicability				Author		Rev		Cross Reference	
	CL				Al Shimer				CC54	
12					Approval Harold Long		Date 9/18/72			

Due to modification in an SMA 12/60 by Technicon, Corp., the H307 Delay Box must be modified so that a 1.2 sec adjustment can be achieved.

SYMPTOMS:

Test result skipped and all results in error from that point on, due to being out of sync with the analyzer.

SOLUTION:

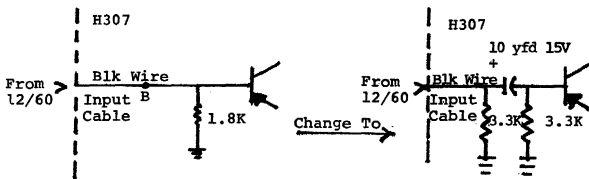

Remove the 1.8K, and replace with one of the 3.3K's.

NOTE: Some components may have to be soldered to the signal lead on input cable.

COMPANY CONFIDENTIAL

Title						Tech Tip				
H710 POWER SUPPLIES						Number H710-TT-1				
All	Processor Applicability					Author	W. Cummins	Rev	0	Cross Reference
						Approval	W. Cummins	Date	7-31-72	

It is possible for the +5VDC supply (H710-Dynage 700-167) to go into an overvoltage or protective mode if the outputs of several H710 supplies are paralleled. The resultant supply output in the overvoltage mode is approximately +1VDC. The supply will come back up to correct voltage if it is allowed to cool.

The vendor (Dynage) acknowledges that a problem may exist (depending upon the system and its operational environment).. The vendor proposes that DEC perform the following temporary change in the supply until the problem can be more explicitly defined and a final fix can be implemented. It is only necessary to perform this change if the supply demonstrates the above symptoms. The vendor also states that the supply is not marginal.

Substitute an 1N750(A) Zener (DEC Part #11-0214) for ZD3 Zener (1N749) currently in use.

The H710 is currently being used in 680I systems.

Title						Tech Tip				
Module Failure in H710						Number H710-TT-2				
All	Processor Applicability					Author	W. Freeman	Rev	0	Cross Reference
						Approval	W. Cummins	Date		

If the module is the cause of the failure of an H710 power supply, it would be less expensive to replace the module than the whole power supply. The module is now available from the Field Service stock with a part number 29-17366.

COMPANY CONFIDENTIAL

PAGE 254	PAGE REVISION 0	PUBLICATION DATE July 1972
----------	-----------------	----------------------------

CPL

digital	FIELD SERVICE TECHNICAL MANUAL				Option or Designator
	12 Bit <input checked="" type="checkbox"/>	16 Bit <input checked="" type="checkbox"/>	18 Bit <input checked="" type="checkbox"/>	36 Bit <input checked="" type="checkbox"/>	H716

Title H716 POWER SUPPLY REPLACEMENT				Tech Tip Number H716-TT-1		
All X	Processor Applicability			Author	Rev	Cross Reference
				Approval H. Long	Date 08/17/72	

When replacing a "Wanlass" type H716 Power Supply due to faulty or erratic operation, specify that the replacement supply is to be the "Armour" type. These new supplies are in stock and will be segregated from the older wanlass supplies. If the stockroom is unable to provide an armour supply, a substitute wanlass will be shipped.

Title H716 FUSES				Tech Tip Number H716-TT-2		
All X	Processor Applicability			Author Jim Cudmore	Rev 8	Cross Reference
				Approval W. Cummins	Date 12/12/73	

WANLASS H716 - H719 POWER SUPPLIES

There is a problem with Wanlass C148A (our H716,H719) Power Supply. This unit is used in the MM8I, H916 and several other applications. Specifically, the output lines +5 and -15 more than likely contain slow blow fuses. The output fuses on the +5 and -15 should be regular fuses. This is particularly critical in the +5 volt line where the over voltage protection SCR may be damaged. This has occurred in several units in the field. The other problem in this supply is that the pass transistors are mounted in such a manner that replacing them is very difficult. It is virtually impossible to make a reliable solder joint. Wanlass's solution, which we should use in the field, is to solder the back of the printed circuit board where the transistor leads pass through with a low temperature solder. They are using Alpha #1 Indium Alloy Solder. This has a much lower melting point than the solder on the opposite side of the board and will allow the pass transistor to be replaced without introducing a cold solder joint on the other side of the board. It is imperative, however, that the solder joint be made carefully and not too much heat applied. All units currently being received from Wanlass are being checked for the proper fuses and good solder joints.

COMPANY CONFIDENTIAL

Title INTERMITTENT OPERATION										Tech Tip Number H716-TT-3					
Processor Applicability										Author Bill Freeman		Rev g		Cross Reference	
All										Approval W. Cummins		Date 12/12/73		H719-TT#1	
X															

The H716 (MM8I typical) and H719 (DW08 typical) power supplies in the field may have intermittent vibration and/or heat problems. This problem can be remedied as follows:

- 1) The two fuse holders on the printed circuit board have rivets securing them to the board. Solder these rivets to the fuse holder.
- 2) The primary fuse holder located on the end of the chassis must have the connector pin soldered to provide a good connection to the base of the fuse holder.
- 3) The power lugs supplying +5V, -15V, and ground have rivets securing them to the circuit board. These rivets should be soldered to the lugs.
- 4) Two power transistors mounted on the chassis have leads extending into the printed circuit board. These leads should be resoldered so that the solder flows freely through the board and makes a good connection to the transistor leads.
- 5) The +5 volt adjustment pot may be intermittent. If by adjusting the pot and returning it to its original position, the voltage output is corrected, exchange the power supply because the problem will return. The wiper in the pot is exposed to the environment and collects garbage causing intermittent operation.

COMPANY CONFIDENTIAL

digital	FIELD SERVICE TECHNICAL MANUAL				Option or Designator H721
	12 Bit <input checked="" type="checkbox"/>	16 Bit <input checked="" type="checkbox"/>	18 Bit <input checked="" type="checkbox"/>	36 Bit <input checked="" type="checkbox"/>	

Title H721 HARDWARE				Tech Tip Number H721-TT-1		
All	Processor Applicability			Author Robert Nunley	Rev 0	Cross Reference
	8I			Approval W. Cummins	Date 07/31/72	

When ordering an H721 to replace other types, it is also necessary to order connectors to fit the H721 outputs. They are:

1 each - 12 pin Mate-N-Lock - 12-09351-12
10 each - pins - 12-09378

Title AC INPUT/PASS-ALONG JUMPERS				Tech Tip Number H721-TT-2		
All	Processor Applicability			Author	Rev	Cross Reference
	X			Approval H. Long	Date 08/17/72	

The 110 VAC 4A available on TB2-3 and 4, 5, and 6 are auto tap-outputs and they should not be used to supply power to grounded devices. If the input for the H721 is 220 VAC, TB 2-3 (110 VAC) output is taken from the "source" side of the AC input and may be 220V above a real earth ground. Refer to ECO #H721-00004 for correction.

Title BAD FAN BEARINGS IN H721 POWER SUPPLY				Tech Tip Number H721-TT-3		
All	Processor Applicability			Author Jeff Blundell	Rev 0	Cross Reference
	X			Approval E. Purcell	Date 11/20/72	

Pamotor 4500C fans with date codes of 11/70 or 12/70 are likely to contain bad bearings.

Any fans with these date codes that fail in the field will be replaced free of charge (material only) by Pamotor, who will supply DEC with enough to cover the respective H721 shipments.

When the new fans arrive they will be put in the Field Service stockroom for issue on an exchange basis, and they will be shipped with captive nuts to get away from the difficulties experienced when trying to replace the present loose nuts.

COMPANY CONFIDENTIAL

Title <i>H721 ADJUSTING POTS</i>						Tech Tip Number <i>H721-TT-4</i>	
Processor Applicability			Author <i>Jeff Blundell</i>		Rev <i>0</i>		Cross Reference
All X			Approval <i>F. Purcell</i>		Date <i>03/08/73</i>		

The present drawing set does not show the physical layout of the regulator board potentiometers, although the board itself is clearly labelled.

As an aid to those who need to adjust them the following drawing may be of use.

*R104 +10 Adjust**

*R204 -15 Adjust**

*R309 + 5 Crowbar Adjust***

*R308 + 5 Current Limit Adjust***

R303 + 5 Adjust

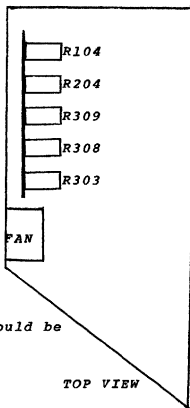

** Glyptol Sealed*

*** Glyptol sealed, do not touch, should be set up with factory H721 Tester*

TOP VIEW

digital	FIELD SERVICE TECHNICAL MANUAL				Option or Designator
	12 Bit <input checked="" type="checkbox"/>	16 Bit <input checked="" type="checkbox"/>	18 Bit <input checked="" type="checkbox"/>	36 Bit <input type="checkbox"/>	H721

Title POWER SUPPLY FAILURE DUE TO HEAT				Tech Tip Number H721-TT-5	
All		Processor Applicability		Author Dennis Sullivan Rev 0	
8	11	15		Approval Jeff Blundell Date 7/11/74	
				Cross Reference	

Fan failure or air flow restriction in the H721 Power Supply can cause excessive overheating, leading to power supply failure.

The thermostat (S1) incorporated in the H721 may be utilized to protect against thermo damage. If an older model power controller is available, for example the 841-B.P.C., the thermostat (S1) can be connected in series with the "cons Pwr Switch" as shown below. The power controller should be dedicated to the thermostat so another device or personnel cannot override the thermostat therefore damaging the power supply in an overheating situation.

Other methods for using the thermostat may be implemented if the user does not exceed the thermostat ratings, which are:

Single-Pole, Single-Throw
 30 Volts DC 6 Amps
 120 V.A.C. 6 Amps
 250 V.A.C. 3 Amps

Opens @ 203°F±5°
 Closes @ 167°F±5°

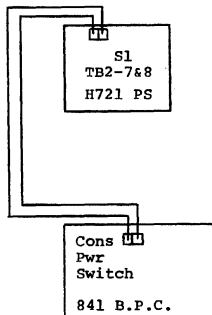

-- NOTES --

digital	FIELD SERVICE TECHNICAL MANUAL				Option or Designator
	12 Bit <input checked="" type="checkbox"/>	16 Bit <input type="checkbox"/>	18 Bit <input type="checkbox"/>	36 Bit <input type="checkbox"/>	H724 to H762

Title Replacement of Transistors Q1 $\beta\beta$, Q2 $\beta\beta$, Q3 $\beta\beta$ H724/H724A Power Supply			Tech Tip Number H724 TT-?		
All Processor Applicability			Author Jim Parker Rev 0		Cross Reference
8E			Approval W.E. Cummins Date 7-31-72		

If the 2N3055 transistors being installed are manufactured by RCA or Solitron this problem will not be experienced. If the transistors to be installed are manufactured by Motorola and marked DEC3055 or 2N3055 longer screws will be needed to fit the nut which holds the screw through the transistors with the collector connection tag. This is due to these transistors having a thicker base plate. The replacement screw is a 6/32 X 3/4" and two per transistor are needed.

Title H724 (A) UL Information			Tech Tip Number H724 TT-2		
All Processor Applicability			Author Ken Quinn Rev 0		Cross Reference
8E			Approval B. Cummins Date		

The PDP-8E power supplies are UL approved. Field conversion of power supplies from 115 VAC to 230 VAC (H724 to H724A) would nullify UL approved. It is therefore recommended that Field conversion be avoided. Also, any field modifications to H724(A), unless accomplished by following a Field Effect ECO could nullify the UL approved.

COMPANY CONFIDENTIAL

Title										HOT +5V FUSE HOLDER - Melted Fuses		Tech Tip Number		H724-TT-3	
All	Processor Applicability					Author Al Deluca		Rev 0		Cross Reference					
14						Approval Jeff Blundell		Date 03/15/73							

Large (i.e. expanded omnibus) 8E's that are drawing more than 16 AMPS at +5 volts may show a tendency to melt their +5V fuses due to the heat build up within the fuse holder.

A better grade of fuseholder, physically interchangeable, bit with silver coated beryllium sprint contacts and a grey termally conductive plastic body, is being phased in to production now, and is available from Field Service Stockroom under DEC Part Number 12-11348.

There is no intention at this time of calling for a mass field retrofit, so this tech tip may be the only field waring you will receive about this problem.

/mt

Title										H762 POWER SUPPLY GROUNDING		Tech Tip Number		H762-TT-1	
All	Processor Applicability					Author Don Herbener		Rev g		Cross Reference					
14						Approval Don Herbener		Date 9/23/74		PDP14/30-TT-1					

This Tech Tip is issued for cross reference purposes only.

COMPANY CONFIDENTIAL

digital	FIELD SERVICE TECHNICAL MANUAL				Option or Designator H8Ø3
	12 Bit <input checked="" type="checkbox"/>	16 Bit <input checked="" type="checkbox"/>	18 Bit <input checked="" type="checkbox"/>	36 Bit <input checked="" type="checkbox"/>	(Connector Block)
Title 288 PIN CONNECTOR BLOCK - P/N 1205348 (Hardware)					Tech Tip Number H8Ø3-TT-1
All	Processor Applicability	Author Lou Nay	Rev Ø	Cross Reference	
X		Approval R. Yurick	Date 02/05/73		

Caution should be experienced when replacing pins in these blocks as they are supplied to us by two (2) different vendors - Sylvania and Cinch - and require different replacement pins.

The vendors and replacement pin part numbers are listed below:

<u>VENDOR</u>	<u>ITEM</u>	<u>Part #</u>	<u>Catalog #</u>
Sylvania	Outside Contact	1205348-03	H805S/set
Sylvania	Inside Contact	1205348-04	H805S/set
Cinch	Outside Contact	1205348-05	H805C/set
Cinch	Inside Contact	1205348-06	H805C/set

/mt

COMPANY CONFIDENTIAL

-- NOTES --

digital	FIELD SERVICE TECHNICAL MANUAL				Option or Designator
	12 Bit <input checked="" type="checkbox"/>	16 Bit <input type="checkbox"/>	18 Bit <input type="checkbox"/>	36 Bit <input type="checkbox"/>	H851

Title INTERMITTENT OVER THE TOP" CONNECTIONS				Tech Tip Number H851-TT-1		
All	Processor Applicability			Author Mike Parry	Rev 0	Cross Reference
	8E	8M	8F	Approval W. Cummins	Date 11/20/72	

For a period the 50-08903 board used on the H851 over the top connector was manufactured using griplets to make the connection through the board. The griplet process can result in bad connections (anything from five (5) OHMS to open circuit), and was ECO'd out of the H851 manufacturing procedure as from September 1, 1972.

The only methods of checking are careful visual inspection under the board, using a solder sucker to clear a hole for inspection or OHM meter checking.

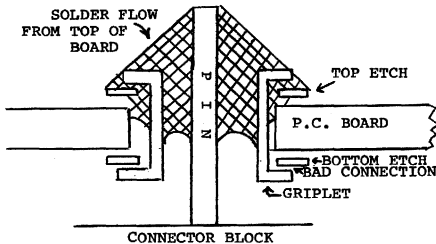

Also, an unknown number of connectors were assembled with the board on backwards. This gives no electrical problem, but could be confusing if you are counting pins for scoping and rely on the "A" etched on the board to find pin A. It could be pin V.

COMPANY CONFIDENTIAL

-- NOTES --

digital	FIELD SERVICE TECHNICAL MANUAL				Option or Designator
	12 Bit <input checked="" type="checkbox"/>	16 Bit <input type="checkbox"/>	18 Bit <input type="checkbox"/>	36 Bit <input type="checkbox"/>	I/O Termination

Title PDP 8 I/O Termination				Tech Tip Number I/O-TT-1		
All	Processor Applicability			Author W. Freeman	Rev o	Cross Reference
	8			Approval W. Cummins	Date 11/15/73	

Pulse ringing on an I/O bus may cause a variety of problems; there are three types of termination which are commonly used to minimize the effects of noise and ringing:

- a) A capacitor and resistor in series which is used for pulses which are positive-going.
- b) A resistor, used alone, is effective for negative-going pulses.
- c) A diode can be used where pulse amplitude reduction would result from resistive termination.

The value of the terminating component/s can be determined from the requirement that ringing be eliminated but that pulse amplitude and rise time not be reduced. Termination is always installed at the end of the I/O bus opposite the origin of the pulse. The "Skip Bus In", for example, is terminated at the CP, the end of the Skip Bus and opposite the origin of the pulse. Other pulses which often require termination are IOP's 1, 2, and 4, BT1, BT2A, and Power Clear. It is important that duplication of termination on a bus not occur; since this is most likely to happen when an option is added to a system, checking for the possibility should be made a standard procedure. There should be one set of terminators and they should be at the last device on the bus.

If the system includes a data break device, Address Accepted and Word Count Overflow pulses may require termination. If more than one data break device is used with a DM01, Address Accepted and Word Count Overflow pulses will be generated in the CP and regeneration will occur from sources within the DM01 logic. It is therefore necessary to check both these signals for ringing both on the CP bus at the DM01 and on the DM01 lines at each of the peripheral data break devices.

Termination components will be found in two mounting configurations, either attached with grip clip connectors or soldered to pins on the wiring side of the logic, or mounted on a W028 C card which is installed in the last I/O device on the bus in the slot corresponding to the cable which inputs the IOP pulses to the I/O device.

Title PDP-8S I/O Termination						Tech Tip Number I/O-TT-2		
All	Processor Applicability					Author W. Freeman	Rev 0	Cross Reference
	8S					Approval B. Cummins	Date 11/15/73	

Because PDP-8S bus drivers differ from those in the PDP-8, different termination is required. Diodes (D664), which do not load the I/O bus drivers are used to remove positive overshoot from the pulses. The diodes are installed with the anode connected to the pulse line which requires termination and the cathode to ground. They are usually mounted on a G701 termination module which is installed in the bus I/O device in the system. A 120 ohm terminator is required on the Stop Bus In line.

Title PDP-8I I/O Termination						Tech Tip Number I/O-TT-3		
All	Processor Applicability					Author W. Freeman	Rev 0	Cross Reference
	8I					Approval W. Cummins	Date 11/15/73	

Termination is required on programmed I/O cables longer than 20', and may be desirable on shorter cables. No special termination module exists for negative bus — IOP 1, 2 and 4. BTS 1 and 3 and INITIALIZE should be terminated with 22 ohm shunt resistors to ground. A G717 termination module provides positive bus termination of 120 ohm shunt resistors to ground on the same signal lines; it should be inserted at the end of the bus on cable #1. If both buses are present in a system, they are electrically independent and must be separately terminated.

EFFECTS OF TERMINATION

	NOT TERMINATED	R AND RC TERMINATED	DIODE TERMINATED	OVER TERMINATED
POSITIVE GOING PULSES			N/A	
NEGATIVE GOING PULSES				

digital	FIELD SERVICE TECHNICAL MANUAL				Option or Designator
	12 Bit <input checked="" type="checkbox"/>	16 Bit <input type="checkbox"/>	18 Bit <input type="checkbox"/>	36 Bit <input type="checkbox"/>	I/O Termination

Title MULTIPLE DRIVE SELECTION				Tech Tip Number I/O-TT-4	
All Processor Applicability				Author W. Freeman	Rev 0
<input type="checkbox"/> 8	<input type="checkbox"/> 8I	<input type="checkbox"/> 8S		Approval W. Cummins	Date 11/15/73
				Cross Reference	

MULTIPLE DEVICE SELECTION

A common problem associated with I/O devices is multiple selection; an IOT is issued to select one device and another, with a different IOT, is also selected. This is often the result of a misadjustment of IOP 4 which allows it to occur, at the peripheral device, coincident with the MB changing to the next instruction. The problem can be examined with a scope using the following program:

```

7000 6777
7001 5200
7002 5200

```

Sync on IOP 4 and look at pin BD on any W103 device selector module at the end of the bus. The time difference between IOP 4 and the spike (which is the MB changing) should be 100 nsec. If the time is shorter than this, check to see that all IOP delays are properly set, then shorten IOP 4 a maximum of 200 nsec. (within a range of 800 to 1000 nsec.) until the time difference between IOP 4 and the spike is 100 nsec.

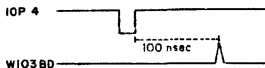

With IOP 4 adjusted for the normal 1 usec. with respect to IOP 2, the microinstruction 6766 (TC01, clear and load status A) may produce a select error. The register is cleared, but not loaded, so that transport 8 (=0) is selected. Reduction of the IOP 4 delay, as described above, will resolve this problem also.

-- NOTES --

digital	FIELD SERVICE TECHNICAL MANUAL				Option or Designator KA8E
	12 Bit <input checked="" type="checkbox"/>	16 Bit <input type="checkbox"/>	18 Bit <input type="checkbox"/>	36 Bit <input type="checkbox"/>	

Title ECO IN ERROR - M835-0003				Tech Tip Number KA8E TT-1	
All 8E		Processor Applicability		Author Bill Moroney Rev 0	
Approval W. Cummins Date 7-31-72				Cross Reference	

ECO M835-00003 is in error. A new ECO #M835-0004 has been generated to correct. The following sketches are correct.

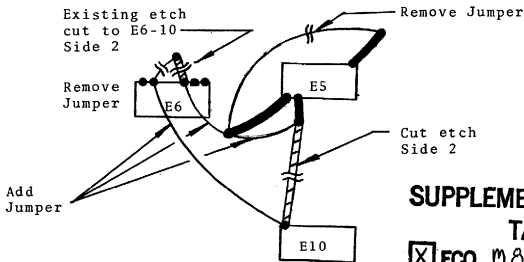

SUPPLEMENTAL ACTION TAKEN

- ECO M835-004
- MCN _____
- TECH TIP _____
- OBSOLETE _____

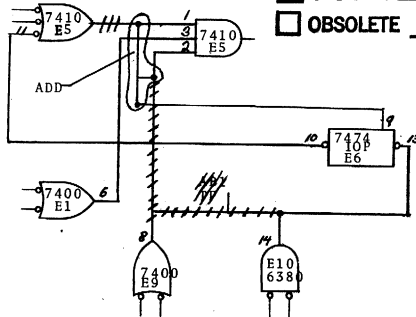

COMPANY CONFIDENTIAL

Title M8350 POSITIVE I/O BUS INTERFACE				Tech Tip Number KA8E TT-2		
All	Processor Applicability			Author Ralph Boehm	Rev 0	Cross Reference
	8E			Approval W. Cummins	Date 7-31-72	

For customer peripherals that need more than 8000 pins, the
separation between IOP's, it is necessary that ECO M8350-0002
be accomplished.

SUPPLEMENTAL ACTION

TAKEN

M835-002

Without the ECO it is possible the IOP will stop timing
at the next TP2. This can cause the KA to restart timing
and send the machine off into random locations memory.

- ECO
- MCH
- TECH TIP
- OBSOLETE

Title COLD SOLDER ON M835				Tech Tip Number KA8E-TT-3		
All	Processor Applicability			Author Weimer/Toolan	Rev 0	Cross Reference
	8E			Approval Frank Purcell	Date 07/31/72	

The ground side of capacitor C16 on the M835 module may be
found to be cold soldered. This is due to the unusually
small pad on side two. Although this problem does not
affect the normal operation of the module, it is advisable
to inspect the connection, and if necessary, resolder from
the component side of the module.

COMPANY CONFIDENTIAL

digital	FIELD SERVICE TECHNICAL MANUAL				Option or Designator KD8E
	12 Bit <input checked="" type="checkbox"/>	16 Bit <input type="checkbox"/>	18 Bit <input type="checkbox"/>	36 Bit <input type="checkbox"/>	

Title Halting During An Interrupt of a Break				Tech Tip Number KD8E TT-#1	
All Processor Applicability		Author Ken Quinn	Rev 0	Cross Reference	
8E		Approval W. Cummins	Date 7-31-72		

This Tech Tip is written to aid the Field Service Representative when operating the PDP-8e and should not be interpreted as a malfunction.

A. INTERRUPT FLAGS

There are certain things which, although illegal, one may do with a PDP-8/81/81, but not with the PDP-8e.

On the PDP-8/81/8L flags were cleared before Interrupt Strobe Time; therefore, a flag could safely be cleared after turning the interrupt on. (This is normally not done because most users have already restored the AC.)

Sample TTY service:

```

/
/
/ SERVICE
/
/ ION
*/ KCC
/ JMP EXIT

```

The PDP-8e clears flags at Interrupt Strobe Time due to the faster I/O cycles. As a result, the above routine would interrupt from location "*" with a cleared (i.e. No.) flag. This would confuse the best Interrupt Scan Routines.

The solution is to follow the rules and clear the flag before the ION command.

This holds true for all options (not just the TTY).

B. HALTING DURING A BREAK

Under certain conditions, it is possible to FETCH a HALT instruction and have a break request in the same cycle (diagnostics are the best example).

With a Break Request, the CPMA, MAJOR STATE, and Instruction Register are disabled at TP4.

The CP MA and EMA in the PDP-8e are updated at TP4 and the machine always stops in TS1. Therefore, under the above conditions the machine stops with the Break MA indicated. The result is one does not know at what address the machine halted.

COMPANY CONFIDENTIAL

Title						Tech Tip		
Halting During An Interrupt of a Break (cont)						Number KD8E-TT-1		
All	Processor Applicability					Author	Rev	Cross Reference
	BE					K. Quinn	0	
					Approval	Date		
					W. Cummins	7-31-72		

B. HALTING DURING A BREAK (continued)

Symptoms If Halted During A Break

1. MD = HALT
2. Turn front panel indicator switch to State.
3. If no major State is visible (BRK or BRK PROG is on) then the above condition exists.

Best Way to Recover Address

1. Depress Single Step, then continue as many times as necessary to obtain the Fetch State.
2. The EM, CPMA generally would now display the address of the Halt command +1.

C. HALTING DURING AN INTERRUPT

It is possible to Fetch a Halt, have an Interrupt Request and the Interrupt Qualified in the same cycle.

Symptoms If Halted During An Interrupt

1. EMA, MA = 0 0000
2. STATUS: ION is Lit
3. STATE: Execute, (IR=JMS)

Best Way to Recover Address

1. Push Single Step down
2. Hit Continue
3. MD = Memory Address of Halt + 1
4. To find EMA issue RIB instruction.

Title						Tech Tip		
DATA BREAK PRIORITY JUMPERS						Number KD8E-TT-2		
All	Processor Applicability					Author	Rev	Cross Reference
	BE	BM	BF			R. Shelley	0	
					Approval	Date		
					J. Blundell		M8360-TT-1	

A number of intermittent system problems that can be traced back to a semi-random change of the program counter have been caused by M8360 Modules not having a data break priority assigned. It is important that ever M8360 has one "A" Jumper moved to the "B" row, even if it is the only M8360 in the system. Check this point every time you P.M. or replace an M8360.

COMPANY CONFIDENTIAL

digital	FIELD SERVICE TECHNICAL MANUAL				Option or Designator
	12 Bit <input checked="" type="checkbox"/>	16 Bit <input type="checkbox"/>	18 Bit <input type="checkbox"/>	36 Bit <input type="checkbox"/>	KE8E

Title				KE8E NORMALIZE INSTRUCTION		Tech Tip Number	KE8E TT-1	
All	Processor Applicability				Author	Dick Weimer	Rev	0
	8E				Approval	W. Cummins	Date	7-31-72
							Cross Reference	

PROBLEM:

The KE8E module M8341, ECO #000002 enables the option to clear the AFC if AC = 4000 and MQ = 0000 prior to issuing a normalize instruction, in the "B" mode of operation.

The Maindec (8E-DOLA), however, does not check this function. The following program patch will check it. MCN #8E-DOLA-2 will follow.

Location

4741	5360	GO TO PATCH
4760	7431	SET "B" MODE
4761	7621	AC & MQ = 0
4762	7330	AC = 4000, MQ = 0000
4763	7411	NORMALIZE
4764	7440	AC SHOULD = 0
4765	7402	NORMALIZE FAILED TO CLEAR AC
4766	7447	SRT "A" MODE
4767	5342	EXIT

Title				...7671 INSTRUCTION PROBLEM		Tech Tip Number	KE8E TT-2	
All	Processor Applicability				Author	Dick Weimer	Rev	0
	8E				Approval	W. Cummins	Date	
							Cross Reference	

The Microprogrammed Instruction "Skip If Mode B" (7671) as specified in the EAE Instruction Set, does not work. If a mode check is desired, the use of the following two instructions is suggested.

7621	Clear the AC and MQ
7451	Double Precision Skip if Zero

If the mode is "B", a skip will occur.

COMPANY CONFIDENTIAL

Title										Tech Tip	
KE8E COMPATIBILITY										Number	
Processor Applicability										KE8E TT-3	
All	Author									Rev	
8E	Dick Weimer									0	
	Approval									Date	
	W.E. Cummins									7-31-72	
	Cross Reference										

- 1) For EAE to run on a four Omnibus system, the M8310 module must be at least Etch rev. B CS rev. F.
- 2) It is possible for the M8340 module (circuit rev. D and earlier) to decode an erroneous EAE instruction while in use on a four Omnibus system. This is due to the relatively high threshold value of the I.C. DEC 380 input buffer and slow rise time of the M.D. bits on the long Omnibus (ECO in progress)
- 3) a. At present it is not advisable to extend any module which transmits or receives the signals AC & MQ load, when using M8341 circuit rev. C. and earlier. Until M8341 circuit rev. D. is available use a module swap method of troubleshooting the EAE.
 - b. When M8341 circuit rev.D becomes available, it will be necessary to extend BOTH the M8300 and M8310 simultaneously when troubleshooting M8310. or M8300. All other modules may be extended individually. (M833, M8340, M8341, M8330)

Title										Tech Tip	
KE8E INSTRUCTION TEST 2 (8E-DOMA)										Number	
Processor Applicability										KE8E TT-4	
All	Author									Rev	
8E	Dick Weimer									0	
	Approval									Date	
	W. Cummins									7-31-72	
	Cross Reference										

- Problem:
- 1) Binary tape does not entirely match the listing.
 - 2) Teletype reader will not read a tape for interrupt testing.
 - 3) Halts defined in the document must be changed to conform to binary tape.

Correction:

- 1) A new Maindec will be released at a later date.
- 2) To start the TTY reader, press any key on the teletype keyboard.
- 3) Change the following halts defined in the document:

Paragraph 5.1.1

ø2ø1 to ø2øø
ø251 to ø25ø

digital	FIELD SERVICE TECHNICAL MANUAL				Option or Designator
	12 Bit <input checked="" type="checkbox"/>	16 Bit <input type="checkbox"/>	18 Bit <input type="checkbox"/>	36 Bit <input type="checkbox"/>	KE8E to KF12

Title KE8E EXTENDED ARITHMETIC ELEMENT				Tech Tip Number KE8E-TT-5	
All	Processor Applicability		Author Dick Weimer	Rev 0	Cross Reference
8E			Approval Frank Purcell	Date 07/31/72	

Part numbers for the Read Only Memories as used on Module M8340 are as follows:

ROM #1, E11 Part Number 23-001A1
ROM #2, E19 Part Number 23-002A1

Title DLD MICRO-PROGRAMMED EAE INSTRUCTION				Tech Tip Number KE8E-TT-6	
All	Processor Applicability		Author J. Blundell	Rev 0	Cross Reference
8E	8M		Approval W. Cummins	Date 07/14/72	

Be aware that the correct code for the DLD Micro-programmed EAE Instruction is 7663.

DLD is a combination of DAD (7443) and CAM (7621) which gives 7663.

The documents in error are schedule to be reprinted as shown below:

Small Computer Handbook - approximately September 1972

Option Bulletin - approximately August 1972

8E Instruction Card - approximately January 1973

If you are aware of any other errors in the above publications, please send them in on a Problem Report and we will try to get them corrected by printing time.

Title SHORT INITIALIZE PULSE (M833/M833 β)				Tech Tip Number KK8E TT-1	
All	Processor Applicability		Author Ken Quinn	Rev 0	Cross Reference
8E			Approval W. Cummins	Date 7-31-72	

If a PDP-8E has a M833 Timing Generator it is possible for a peripheral to miss the Initialize pulse when powering up the processor. This can happen if the processor issues the relatively short initialize pulse before the peripheral is "up-to-power".

An indication of this problem could be "Tape Runaway". If the drive is under remote control and has unit 0 selected at the time the system is powered up the tape may drive in one direction until the clear key is depressed. This problem is taken care of by the M8330 Timing Generator Module (the initialize is 550 ms long). If the problem is observed, the M833 should be exchanged for a M8330.

PAGE 277	PAGE REVISION 0	PUBLICATION DATE
----------	-----------------	------------------

Title						MICROPROGRAM CONFLICT		Tech Tip Number		KE12-TT-1	
All	Processor Applicability					Author		Rev		Cross Reference	
	12					H. Long		0			
						Approval		Date			
						H. Long		8-17-72			

A software (hardware) problem has been reported in the KE12. Instructions CLA (7601) and NMI (7411) are defined as being micro programmable. Due to a hardware problem they do not function properly when micro programmed. Hence, the instructions CLA (7200) and NMI (7411) should be used as two separate instructions.

No correction is planned for the hardware.

Title						LIF INHIBITING PUSH J		Tech Tip Number		KF12-TT#1	
All	Processor Applicability					Author		Rev		Cross Reference	
	12					HAROLD LONG		0			
						Approval		Date			
						HAROLD LONG		12/22/72			

A recent problem revealed a possible misunderstanding in the field with the LIF instruction. Like the 8 mode CIF instruction, the Linc mode LIF instruction inhibits interrupts. But unlike CIF, LIF requires two jumps before interrupts are freed.

The problem was encountered by a customer doing an LIF/JMP sequence and then a PUSH in the new field. Since a PUSH is prohibited (by definition) when interrupts are inhibited and a JUMP had not been executed in the new field, strange things happened. The strangeness is eliminated by doing a JMP.+1 upon entering the new field.

digital	FIELD SERVICE TECHNICAL MANUAL				Option or Designator KL8E
	12 Bit <input checked="" type="checkbox"/>	16 Bit <input type="checkbox"/>	18 Bit <input type="checkbox"/>	36 Bit <input type="checkbox"/>	

Title KL8E (M865) INTERMITTENT PROBLEMS				Tech Tip Number KL8E TT-1	
All 8E	Processor Applicability		Author Dick Weimer	Rev 0	Cross Reference
			Approval W. Cummins	Date 7-31-72	

M865 - PROBLEM: Some crystal clocks will not start due to circuit impedance.

SUPPLEMENTAL ACTION TAKEN

- ECO M865-003
 MCN _____
 TECH TIP Solution:
 OBSOLETE _____

SOLUTION: Add a 10 picofarad capacitor across crystal output leads.

M865 - Problem: Noise spike may clear reader run, manual restart required.

Delete etch connection to E46 Pin 11, add jumper from E40 Pin 8 to E46 Pin 11.

(Reference ECO M865-~~0000~~03)

Title KL8E TTY Control (M856, M8650)				Tech Tip Number KL8E TT-2	
All 8E	Processor Applicability		Author Bill Freeman	Rev 0	Cross Reference
			Approval W. Cummins	Date 7-31-72	

There are two (2) module types that may be used as teletype interfaces in PDP-8E's, the M865 and M8650. The M8650 may be used as a replacement for the M865 (double check the M8650 jumpers to insure they conform - referencing engineering specification A-SP-KL8-E-1).

The M865 may not be used indiscriminately as a replacement for the M8650 except when the M8650 is used as the console teletype and the console device is 110 baud.

The M8650 and M8650YA modules are the same except for operating frequencies. The M8650 has a crystal for 110 baud operation and the M8650YA has a crystal for multiples of 2400 baud. The part number for the M8650 crystal is 18-09880-01 while the M8650YA crystal is 18-09880-02. In emergency situations, the boards may be exchanged merely by changing the crystal.

COMPANY CONFIDENTIAL

Title FAULTY I.C. ON KL8E						Tech Tip Number KL8E TT-3		
All	Processor Applicability					Author Bill Freeman	Rev 0	Cross Reference
	8E					Approval W. Cummins	Date 7-31-72	

If converting M8650 to a M8650YA or experiencing garbled data on a M8650, insure the I.C. E22 (74193) is not manufactured by National. Replace this chip with one manufactured by Texas Instruments to correct the problem.

Title KL8E Device Codes (M8650)						Tech Tip Number KL8E TT-4		
All	Processor Applicability					Author Bill Freeman	Rev 0	Cross Reference
	8E					Approval W. Cummins	Date 7-31-72	

The KL8E (M8650) has jumper selectable I/O device codes. Unless the customer requests, or the system configuration requires a deviation from standard, the select codes will be 03-04 for console and 30-31, 32-33, 34-35, 36-37 for added units. The device codes for TSS8E and EDU systems configured by production will be:

<u>KL8E#</u>	<u>KL8E Device Code</u>
0 (console)	03/04
1	40/41
2	42/43
3	44/45
4	46/47
5	34/35
6	11/12
7	30/31
8	32/33
9	50/51
10	52/53
11	54/55
12	56/57
13	70/71
14	36/37
15	72/73
16	74/75

If a KL8E is to be a field add on, the option will be delivered with device code 03/04.

Reference pages 12, 13, 14, and 15 of the KL8E engineering spec in the PDP-8E print set to change or check the jumpers.

COMPANY CONFIDENTIAL

digital	FIELD SERVICE TECHNICAL MANUAL				Tech Tip Option or Designator KL8E
	12 Bit <input checked="" type="checkbox"/>	16 Bit <input type="checkbox"/>	18 Bit <input type="checkbox"/>	36 Bit <input type="checkbox"/>	

Title M8650, PRINT CORRECTIONS			Tech Tip Number KL8E TT-5		
All Processor Applicability		Author Ken Quinn	Rev 0	Cross Reference	
Approval W. Cummins		Date 7-31-72			

Some M8650, C.S. Rev. A prints were shipped without the hand made change added to the circuit which would make them C.S. Rev. B. The change to the circuit is shown below.

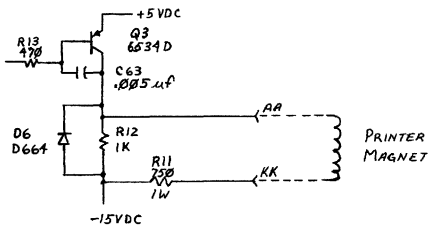

C.S. REV. A

C.S. REV. B

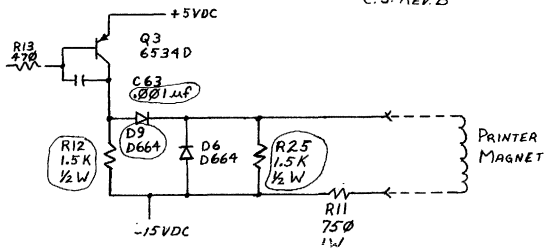

COMPANY CONFIDENTIAL

Title					CHECKSUM ERRORS ON LONG TAPES		Tech Tip Number		KL8E-TT-6		
All		Processor Applicability			Author		Mountain View F/S Rev		0		
8E		8M		8F		Approval		J. Blundell		Date	
										Cross Reference	
										12/07/72	

Intermittent errors when reading in long binary tapes can often be cured by installing a logic change described in ECO M8650-002. (The ECO is a one year old phase in ECO which has not yet been implemented in Production.)

The relevant portion of the ECO reads as follows:

Problem: Gradual frequency drift of incoming data relative to receiver clock allows logic hazard to occur in receiver shift register under worst case IC combination.

Correction: Guarantee E6/E10 shift register is allowed proper setup time by cutting Etch at E11 pin 9. RUN JUMPER E11 pin 9 to E4 pin 6. Cut Etch at E7 pin 10. RUN JUMPER E7 pin 10 to E4 pin 8. ADD JUMPER E3 pin 5 to E12 pin 9.

This correction applies only to Etch Rev. C boards and is already represented graphically on Rev. C and later circuit schematics.

Modules shipped to date have CS Rev. D stamped on their handles, BUT DO NOT INCORPORATE THE ABOVE CHANGE.

COMPANY CONFIDENTIAL

DIGITAL EQUIPMENT CORPORATION

digital	FIELD SERVICE TECHNICAL MANUAL				Option or Designator
	12 Bit <input checked="" type="checkbox"/>	16 Bit <input type="checkbox"/>	18 Bit <input type="checkbox"/>	36 Bit <input type="checkbox"/>	KL8E

Title ECO HISTORY AND EXPLANATION				Tech Tip Number	KL8E-TT-7	
All	Processor Applicability			Author	Rev	Cross Reference
	8E	8M	8F	Jeff Blundell	A	
			Approval	Date		
			Frank Purcell	02/23/73		

The M8650 was production released at CS Rev. A, Etch B, and has had six ECO's to date. One of these (ECO #2) was a phasein ECO that is only just starting to appear on the field, although it did correct a logic problem that could cause checksum errors when reading long tapes.

This phasein has led to some confusion in the numbering of the various circuit schematics, and below is a summary of the ECO's to help you understand where we are today.

ECO #	CS	ETCH	
	A	B	Product Release
1	B	C	Mandatory. Reworks 20MA output circuit
2	C	D	(1) Corrects receiver buffer logic (2) Corrects drawings (3) Adds 2400 baud lugs (4) Adds diodes to EIA chip supply
3	D	D	Mandatory. Changes IOT decoding enabling level to ground.
4	E	D	Changes IOT decoding enabling level to MD decode.
4A	E	D	Mandatory only if ten or more KL's on system.
5	B1	B or C	Adds parts 1 and 2 of ECO #2 to boards with ECO's 1 and 3. Field retrofit only when having read in problems.
6	E1	B or C	Updates B1 CS to E1 to include ECO's 4 and 4A when needed on field.

Be aware that many boards without ECO #2 (i.e. etches B and C have been shipped by production (both US and Galway) but with ECO's 1 and 3 and have been called CS Rev. D. Galway requested special drawings to reflect the situation and were told to call them B1 and an ECO was promised. That ECO was never written, and ECO#5 that DOES create B1 ALSO includes parts of ECO #2. This means that prints sent out on Galways B1 waivers will not agree with the machine until ECO #5 has been implemented.

COMPANY CONFIDENTIAL

Title						TTY STATIC NOISE PROBLEM						Tech Tip Number		KL8E-TT-8	
All		Processor Applicability				Author		Don Herbener		Rev		A		Cross Reference	
						Approval		Frank Purcell		Date		03/29/73			

There is a static TTY noise problem which is particularly noticeable on multiple TTY user 8E and 8M systems such as EDU-Systems. Engineering has come up with a static filter kit available under part number H7981. Order one kit plus X number of additional TTY line filters for each additional TTY that is on the system.

Title						INCORRECTLY WIRED TTY CABLE ASSEMBLY						Tech Tip Number		KL8E -TT-9	
All		Processor Applicability				Author		Chris Norris		Rev		0		Cross Reference	
		8E 8M 8F				Approval		Frank Purcell		Date		2/5/74			

There is a possibility that several TTY cable assemblies 70-08360 which are incorrectly wired have found their way into the field.

The mistake is that the following two wires are being interchanged.

<u>Mate-N-lock</u>	<u>Burg: Conn.</u>	<u>Signal Name</u>	<u>Color</u>
P1-4	P2-EE	Reader Run. (20 ma)	Black
P1-2	P2-KK	Serial out (-20ma)	Black

The result is that R9 will burn on the M8655. As both wires that are in error are black and the TTY appears to operate normally for a considerable time, the problem is not readily apparent.

To check for the problem on either module, monitor Pin EE of J1 with a scope while the TTY is printing. If the voltage is stable then the cable is wired correctly.

Title						KL8-EA Incompatible With 113B Modem						Tech Tip Number		KL8E-TT-10	
All		Processor Applicability				Author		Sedgwick/Sweeney		Rev		0		Cross Reference	
		8E 8F 8M				Approval		F. Purcell		Date		2-28-74			

KL8-EA INCOMPATIBLE WITH 113B MODEM

Some difficulties have arisen when attempting to connect a Bell 113B series Modem to a KL8-EA.

The problem symptom shows up as the signal line "FORCE BUSY" (from the Modem) being held true at all times. This occurs because the line that carries "FORCE BUSY" is tied to ground (pin "C") when the BC91V cable plugs into the M8650.

The pin assignments on the M8650 were arrived at from EIA Standard RS-232-C. At that time, modem pin 25 was unassigned. Further, this particular circuit (circuit "CN" in the 113B Modem) is a customer option. According to the 113B Manual it can be disabled internal to the Modem.

p.284 If problems are encountered in this area, it is recommended that the customer be informed that he needs this modification.

digital	FIELD SERVICE TECHNICAL MANUAL				Option or Designator
	12 Bit <input checked="" type="checkbox"/>	16 Bit <input type="checkbox"/>	18 Bit <input type="checkbox"/>	36 Bit <input type="checkbox"/>	KL8J

Title				Tech Tip		
INCORRECTLY WIRED TTY CABLE ASSEMBLY				Number KL8J-TT-1		
All	Processor Applicability			Author	Rev	Cross Reference
	8E	8M	8P	Chris Norris	g	
				Approval	Date	
				Frank Purcell	2/5/74	

This Tech Tip is issued for cross reference purposes.

Title				Tech Tip		
KL8-JA JUMPER CONFIGURATION				Number KL8J-TT-2		
All	Processor Applicability			Author	Rev	Cross Reference
	8E			Bill Eash	0	
				Approval	Date	
				D. Staupe		

Cross Reference Purposes Only.

-- NOTES --

digital	FIELD SERVICE TECHNICAL MANUAL				Option or Designator
	12 Bit <input checked="" type="checkbox"/>	16 Bit <input type="checkbox"/>	18 Bit <input type="checkbox"/>	36 Bit <input type="checkbox"/>	KM8E

Title Time Share Clearing User Mode Flip/Flop				Tech Tip Number	KM8E TT-1	
All	Processor Applicability			Author Robert Shelley	Rev 0	Cross Reference
	<input checked="" type="checkbox"/> 8E	<input type="checkbox"/>	<input type="checkbox"/>	Approval W.E. Cummins	Date 7-31-72	

Problem:

It may be found impossible to manually clear the "User Mode" bit (except by turning power off and on) on M837 modules at etch Revision B, even though the handle stamp indicates the module has been ECO'd to circuit schematic Revision C or D.

This is because most of ECO M837-00001 (circuit schematic Revision C) was never installed on these modules. When Revision C is fully installed the User Mode 'Buffer' (labeled "DB" on print M837-0-1, 2 of 3) is cleared by the load-address key. (The extended load-address key clears the user flop itself.)

Revision C and D prints are correct but the following changes must be made to the module if it's etch revision is B.

The steps below refer to the drawing that follows:

1. Cut etch at E19-6, side 2.
2. Cut etch at E19-5, side 1.
3. Cut etch at E19-4, side 1.
4. Cut etch at E19-4, side 2.
5. Add jumper from E19-6 to E29-3.
6. Add jumper from E23-11 to E29-6.
7. Add jumper from E29-5 to Feed-through shown on the drawing.
8. Add jumper from E19-4 to Feed-through shown on the drawing.
9. Add jumper from E19-5 to feed-through shown on the drawing.
10. Add jumper from E19-8 to feed-through shown on the drawing.
11. Add jumper from E29-4 to feed-through shown on the drawing.
12. Cut etch at E40-11, side 1.
13. Add jumper from E40-11 to E25-9.

Modules at etch revision C are already correct. Ref. ECO M837-00003.

SUPPLEMENTAL ACTION TAKEN

- ECO M837 003
- MCN _____
- TECH TIP _____
- OBSOLETE _____

COMPANY CONFIDENTIAL

Title TIME SHARE CLEARING USER MODE FLIP-FLOP (Continue)							Tech Tip Number KM8E-TT-1		
All Processor Applicability				Author Robert Shelley		Rev 0		Cross Reference	
Approval W. Cummins				Date 07/31/72					

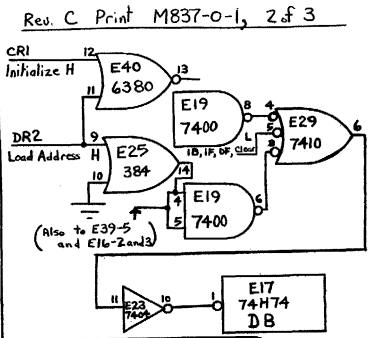
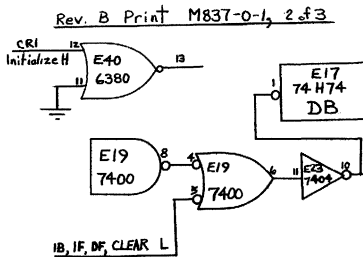

Make adds and deletes as per this drawing.

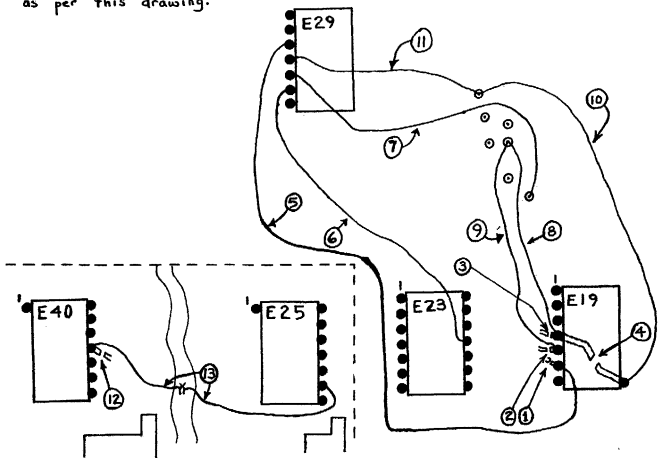

COMPANY CONFIDENTIAL

digital	FIELD SERVICE TECHNICAL MANUAL				Option or Designator
	12 Bit <input checked="" type="checkbox"/>	16 Bit <input type="checkbox"/>	18 Bit <input type="checkbox"/>	36 Bit <input type="checkbox"/>	KP8E

Title POWER FAIL OPTION (M848)				Tech Tip Number KP8E-TT-1		
All	Processor Applicability			Author Ken Quinn	Rev 0	Cross Reference
	8E			Approval W. Cummins	Date 6/01/72	

If a PDP-8E has an M8330 Timing Generator and a power fail option, KP8E, the power fail module should be either an M848 CS. Rev. F, or later, or an M8480.

	M833 Short Init**	M8330 Long Init**
M848F*	✓	✓
M8480		✓

* All M848's should be ECO'd to CS Rev. F or later

** Generated by Power OK.

Title KP8E (M848), Proper Selection of Threshold Jumpers				Tech Tip Number KP8E-TT-2		
All	Processor Applicability			Author Ken Quinn	Rev 0	Cross Reference
	8E			Approval W. Cummins	Date 6/01/72	

Due to the design characteristics of the PDP8/E, the Power supply (H724) may be providing power to many different "option" modules. The M848 module has three (3) pairs of jumpers on it to select the correct thresholds, which will vary with the load, for each particular configuration. Also, they may be used to help compensate for poor line voltage conditions (E.G. 95 to 105 VAC).

For example; if a PDP-8E has many modules plugged into its OMNIBUS and there is a loss of AC power, the DC voltages will decay faster than they would if it was a basic PDP-8/E. Therefore, the power fail threshold may need to be set higher for a "larger" PDP-8E.

/mt

COMPANY CONFIDENTIAL

Title						DAMAGE TO CABLES (KP8E/DK8EA)		Tech Tip Number		KP8E-TT-3		
All						Processor Applicability			Author Ken Asbury		Rev 0	
8M		8F				Approval		E. Purcell		Date 11/20/72		
									Cross Reference			
									DK8E-TT-3			

Title						INCORRECT INSTALLATION OF ECO M848-0014		Tech Tip Number		KP8E-TT-4		
All						Processor Applicability			Author Len Rogers		Rev	
8e		8m		8f		Approval		J. Blundell		Date 3 May 73		
									Cross Reference			

A number of M848 (Power Fail Option) have recently been seen in depot repair and in the field with ECO M848-0014 installed incorrectly.

The wires affected should run from E13 pin 2 to E13 pin 12 and E13 pin 3 to E13 pin 11. The bad modules may have one or both of the wires to pins 11 and 12 connected to pins 12 and 13 respectively.

Bad modules will fail test 4 of the KP diagnostic.

To summarize:

ECO M848-0014 called for the addition of three wires.

From	To
E13 Pin 1	CU 2
E13 Pin 2	E13 pin 12
E13 Pin 3	E13 pin 11

This ECO brings the board up to C.S. Rev. R, is mandatory on systems without a programmers console, and depends on the installation of earlier ECO's to free up the gate at E13 which it makes use of.

COMPANY CONFIDENTIAL

DIGITAL EQUIPMENT CORPORATION

digital	FIELD SERVICE TECHNICAL MANUAL				Option or Designator
	12 Bit <input checked="" type="checkbox"/>	16 Bit <input type="checkbox"/>	18 Bit <input type="checkbox"/>	36 Bit <input type="checkbox"/>	KP8L to KV8I

Title G785/MC8L/KP8L COMPATIBILITY				Tech Tip Number KP8L-TT-1		
All	Processor Applicability			Author Art Newbery	Rev 0	Cross Reference MC8L-TT-1
	8L			Approval Frank Purcell	Date 07/31/72	

Title KT12 VS OTHER OPTIONS (IOT CONFLICTS)				Tech Tip Number KT12-TT-1		
All	Processor Applicability			Author Harold Long	Rev	Cross Reference
	12			Approval Harold Long	Date 8/7/72	

The IOT for DEctape TC01 conflicts with PDP-12's KF12. The PDP-12 will probably never have a TC01 option. There is, however, an IOT conflict with some of the "8" diagnostics the PDP-12 user.

The following is a list of conflicting diagnostics and their location to be changed to on NOP (7000).

			<u>LOC</u>	<u>OLD</u>	<u>NEW</u>
DF32 Diskless	MAINDEC-08-D5BC	1351	6762	7000	
Time Share Hardware Exerciser	MAINDEC-T8-D8BB	2632	6771	7000	
LE8/LP08 Line Printer Test	MAINDEC-8I-D2AC	3116	6762	7000	

Title SCOPE ERASE RETURN PROBLEM				Tech Tip Number KV8-TT-1		
All	Processor Applicability			Author Al Shimer	Rev 0	Cross Reference VT01-TT-1
	8			Approval Dave Starratt	Date 1/74	

COMPANY CONFIDENTIAL

Title 611 Scopes						Tech Tip Number KV8I-TT-1		
All 8's	Processor Applicability					Author R. Nunley	Rev 0	Cross Reference
						Approval W. Cummins	Date 7-31-72	

Some older Tektronix 611 scopes have a potentially disastrous flaw. The leads on the secondary of the high voltage transformer do not have sufficient insulation to withstand long usage and will break down and short the cathode voltage (leads 8 & 9) to ground. To cure, unsolder leads 8 & 9 from the ceramic strip, cover those leads with a heavier teflon spaghetti then resolder to the same spots on the ceramic strip.

Title KV8I Problems						Tech Tip Number KV8I-TT-2		
All 8I	Processor Applicability					Author R. Nunley	Rev 0	Cross Reference
						Approval W. Cummins	Date	

An error in the Add/Delete lists for ECO's 8I-00021 and 00036 has resulted in the introduction of peculiar problems into the KV8I. Some KV8I's have left the plant improperly wired.

The error: ADD D10E2 to E09L2
Correction: ADD E09V1 to E09L2

A jittery presentation on a VT01 may be the result of a faulty ground between the VT01 and the 8I. It is probable that the situation can be improved or corrected by plugging the VT01 into the 8I power supply or in any DEC option.

COMPANY CONFIDENTIAL

PAGE 292	PAGE REVISION 0	PUBLICATION DATE July 1972
----------	-----------------	----------------------------

digital	FIELD SERVICE TECHNICAL MANUAL				Option or Designator
	12 Bit <input checked="" type="checkbox"/>	16 Bit <input type="checkbox"/>	18 Bit <input type="checkbox"/>	36 Bit <input type="checkbox"/>	KW12A

Title	TESTING KW12 ECO'S	Tech Tip Number	KW12A-TT-001
All	Processor Applicability	Author	Rev 0
	12	Approval <i>H. Long</i>	Date 9/14/72
			Cross Reference

Two recent ECO's, EM12-00019, EM12-00020, involving the KW12 provide solution to program sensitive hardware glitches. In the case of the KW12, the fix should be tested with the following equipment:

1. An Oscilloscope -- Tektronix Type 454
2. A Signal generator 1 KHz to 300 KHz
3. A simple program

```

CLA
TAD KØ1ØØ          /CONSTANT + (0IØØ)
CLEN                /ENABLE CHAN 1 INPUT
CLA
TAD K6ØØØ          /CONSTANT = (6ØØØ)
CLLR                /SET RATE = CHAN 18INPUT
CLCA                /READ COUNTER TO AC
JMP -.1            /LOOP
KØ1ØØ, Ø1ØØ
K6ØØØ, 6ØØØ

```

The following procedure should be used to test the KW12 ECO's

1. Turn the PDP-12 off (turn the power fail option off also).
2. Turn the PDP-12 on and, before touching any console keys attach a scope probe to D24, pin R1.

With the sweep rate set to 0.2 usec/div and the vertical range set to 2 v/div, the following pulse train should be observed

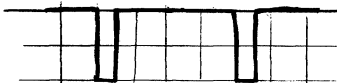

3. Start the test program.
4. Attach the signal generator to channel 1 input of the KW12 and set sine wave output to at least 3v pp with a rate of 1 KHz
5. Turn the channel one slope knob to both the + and - settings. Counting should be observed in the AC. If counting fails with the slope selector in that slope position, the front panel ECO was incorrectly installed or the precision power supply is faulty.

COMPANY CONFIDENTIAL

Title TESTING KW12 ECO'S continued						Tech Tip Number KW12A-TT-1	
All	Processor Applicability				Author	Rev 0	Cross Reference
	12				Approval H. Long	Date	

6. With the slope control set to + or -, increase the frequency of the signal generator slowly to 120 KHz. The AC should continue to change very rapidly. This test should be allowed to run for five minutes with the signal generator set to 120 KHz.
7. If the AC stops changing at any time, except when switching ranges on the signal generator, and can't be restarted by adjusting the KW12 threshold control, (without touching the console switches), either ECO's were not correctly installed or the M719 in slot F20 or the M503 in slot F23 is faulty
8. The M719's and the M503's should be interchanged and the test repeated.

Title WIRING ERRORS						Tech Tip Number KW12A-TT-002	
All	Processor Applicability				Author	Rev 0	Cross Reference
	12				Approval H. Long	Date 9/14/72	

Problems encountered on the KW12 installation of PDP-12's prior to memory section 194 may in part be caused by incorrect wiring from slot F25 to the clock control. Below is a list of the wiring runs for a Rev. F memory frame. If the wire panel is a Rev. E or earlier, verify all clock wiring with this list.

<u>Name</u>	<u>FROM</u>	<u>TO</u>
CLEA F25A1	F25A1	F23H2
CLEA F25B1	F25B1	F23H1
CLEC F25C1	F25C1	F24D1
GND 25	F25C2	F25T1
CLEC F25D1	F25D1	F24E1
CLEB F25E1	F25E1	F23K2
GND 25	F25F1	F25T1
CLEB F25H1	F25H1	F23K1
CLEC F25J1	F25J1	F24H2
CLEC F25K1	F25K1	F24H1
CLEA F25L1	F25L1	F23J2
CLEB F25M1	F25M1	F23L2
CLEC F25N1	F25N1	F24J2
GND 25	F25R1	F25F1
GND 25	F25T1	E25T1

COMPANY CONFIDENTIAL

digital	FIELD SERVICE TECHNICAL MANUAL				Option or Designator
	12 Bit <input checked="" type="checkbox"/>	16 Bit <input type="checkbox"/>	18 Bit <input type="checkbox"/>	36 Bit <input type="checkbox"/>	KW12A

Title DIFFERENT WAYS OF USING AND PROGRAMMING KW12A				Tech Tip Number KW12A-TT-3	
All	Processor Applicability		Author	Rev 0	Cross Reference
	12		Approval <i>H. Long</i>	Date 9/14/72	

Different ways of using and programming the KW12A are shown up glitches and errors in the clock circuitry. The problems are noted as follows:

- When running at the higher clock rates and short overflow intervals such as at every 20-60 usec, the pulse that occurs when reaching the desired count and causing counter overflow shifts in time. This is caused by a glitch on the clear line of CLR count F/F which is too narrow to clear the flop but is wide enough to cause the "0" side output to have a spiked output which is seen by the counter as a valid count, which causes overflow too soon. This seriously affects the AIP-12.
- When operating in mode 3 when an event occurs the counter is transferred to the buffer and the counter is cleared. If counter bit $\beta\beta$ were set prior to clearing, it generates a false overflow. The overflow F/F detects this as a valid complete counter full overflow. This could mess up customer programs badly.
- The positive and negative sync inputs cause the opposite slope to be synchronized on. The threshold polarity is correct as marked but does not cover the full range of defined input signal voltages.

These problems are corrected by ECO EM12- $\beta\beta$ 55

Title ECO PROBLEMS				Tech Tip Number KW12-TT-4	
All	Processor Applicability		Author	Rev 0	Cross Reference
	12		Approval <i>H. Long</i>	Date 9/13/72	

After installing ECO EM12-0055, the following software will not operate correctly:

- KW12-A Maindec 12-D8CC will not run.
- KW12-A onlinctapes up to and including DEC 12-D7AG-U0 will not run
- The clock demo on linctapes up to and including DEC-12-UXZC-U0 will not run.
- Customer software using β CLK A CNT $\beta\beta$ to set the overflow flag will be affected.

May not operate correctly:

- Customers software that uses the Schmidtt trigger inputs.

Will operate correctly:

- KW12-A Maindec 12-D8CD.
- Linctapes DEC 12-D7AH-U0 or higher

COMPANY CONFIDENTIAL

-- NOTES --

digital	FIELD SERVICE TECHNICAL MANUAL				Option or Designator
	12 Bit <input type="checkbox"/>	16 Bit <input checked="" type="checkbox"/>	18 Bit <input checked="" type="checkbox"/>	36 Bit <input checked="" type="checkbox"/>	LA30

Title				Off-Line Testing of the LA30		Tech Tip Number	LA30 TT-#1
All	Processor Applicability			Author	Cloutier/Walker	Rev	0
X				Approval	W. Cummins	Date	07/31/72
							Cross Reference

To check out LA30 off-line (locally) you have to place a jumper from A15R2 to ground. This jumper is located on the M7712 module which qualifies key board in to work. Also, let it be known that the first slot to the left of the wire frame is slot A and B05 respectively.

Title				LA30 HEAD INSTALLATION		Tech Tip Number	LA30-TT-2
All	Processor Applicability			Author		Rev	0
X				Approval	H. Long	Date	8/2/72
							Cross Reference

On the initial start-up of an LA30 head, some solenoids may not print immediately. This condition comes about when the head has been sitting idle for a long period of time. In most cases the solenoid will free itself during normal printing but if it doesn't it may have to be freed by hand. To free the solenoid by hand, proceed as follows:

1. Turn off the LA 30 power
2. With paper and ribbon in position and the platten closed, insert the end of a paper clip through the hole in the rear of the solenoid and push gently against the solenoid spring.
3. Remove paper clip.
4. Check to make sure solenoid wire is not sticking in the ribbon.
5. Turn on LA30 power and print.
6. Once the solenoid starts printing run the head continuously for a minimum of two passes of the LA30 diagnostic.

NOTE: The longer the head is run there is less chance of this happening again.

COMPANY CONFIDENTIAL

digital	FIELD SERVICE TECHNICAL MANUAL				Option or Designator
	12 Bit <input checked="" type="checkbox"/>	16 Bit <input checked="" type="checkbox"/>	18 Bit <input checked="" type="checkbox"/>	36 Bit <input checked="" type="checkbox"/>	LA30

Title DECwriter Ribbons - Recall				Tech Tip Number LA30-TT-4	
All	Processor Applicability			Author Bryan Dungey	Rev 0
X				Approval Ed Dorr	Date 09-05-72
					Cross Reference

We have discovered that one shipment of DECwriter ribbons, which were over inked, were put into stock sometime around the first of the year. The ribbons can be identified by the lot #35 which is printed on each ribbon carton.

These ribbons will smudge badly and should be recalled from all field stock areas. Maynard and Westfield Stockrooms have already been purged.

Title PASS ON SOME BASIC 8E MAINDECS BECAUSE OF NO BELL				Tech Tip Number LA30-TT-5	
All	Processor Applicability			Author Daryl Rickards	Rev 0
X				Approval J. Blundell	Date 09/20/72
					Cross Reference

As there is no bell on the Basic 8E Maindecs, there is no indication of a pass on some of the Basic 8E Maindecs. The following changes give a "P" for pass when running these maindecs.

Instruction Test 1 ECO ~~change location #129 from #287 to #328~~
 Instruction Test 2 ECO ~~change location #761 from #287 to #328~~
 Random DCA MCN ~~change location #813 from #287 to #328~~
 Basic JMP-JMS ECO ~~change location #587 from #287 to #328~~
 EAE Inst. Test 2 TECH TIP ~~change location 2175 from #287 to #328~~

(N.B. this change will OBSOLETE (take a minute) -

Title LA30 INTERMITTENTLY STOPS PRINTING				Tech Tip Number LA30-TT-6	
All	Processor Applicability			Author J. Blundell	Rev 0
X				Approval F. Purcell	
					Cross Reference

PROBLEM CAUSE: Right margin switch (N/O contact) floating into ML13 pins H1 and J1 at A17.

Cure: Add a jumper A17 H1 to A17 U1 to clamp the line to pins 3.

There will shortly be an ECO to make this a retrofit.

Title KEYBOARD SHORTS CAUSED BY PAPERCLIPS, ETC.				Tech Tip Number LA30-TT-7	
All	Processor Applicability			Author Davis/Barnett	Rev 0
X				Approval W. Cummins	Date 11/20/72
					Cross Reference

Title APPARENT LINE FEED PROBLEMS IN 50 Cycle Land						Tech Tip Number LA30-TT-8		
All		Processor Applicability		Author Klaus Wunderlich		Rev 0		Cross Reference
X				Approval W. Cummins		Date 01/23/73		

Some LA30's in the Munich area have been found to be wired for 220 volts 60 cycles, resulting in a hot power supply, and low unregulated D.C. output voltages. We have seen this to cause line feed problems.

There is a jumper from the 2mfd resonating capacitor to the transformer that selects the correct circuit to match the power frequency.

Capacitor to Tag 9 - 50 cycles/second

Capacitor to Tag 10- 60 cycles/second.

Title CARRIAGE RETURN TIME ON SERIAL LA30						Tech Tip Number LA30-TT-9		
All		Processor Applicability		Author Carl Cline		Rev 0		Cross Reference
X				Approval W. Cummins		Date 02/26/73		

SUPPLEMENTAL ACTION TAKEN

The carriage return time is specified to be 300 ms or less. However it appears that only a small percentage of the G936 accelerator card achieve an acceptable time. This is due to the change in tolerance of the components on the G936, and will result in a loss of the second character following a carriage return.

An ECO will be listed to resolve this problem. In the mean time additional fill characters may be added following a CR.

TECH TIP
 OBSOLETE

Title LACK OF FUSING ON THE LINE FEED CIRCUITS						Tech Tip Number LA30-TT-10		
All		Processor Applicability		Author Carl Cline		Rev 0		Cross Reference
X				Approval W. Cummins		Date 02/26/73		

This problem causes the line feed resistors to smoke on the which can damage the board as well as be embarrassing to the customer. ECO 8 was generated to correct this problem, however, the value specified (2½ amps) is too large so a 1½ amp slow blow should be used.

COMPANY CONFIDENTIAL

DIGITAL EQUIPMENT CORPORATION

digital	FIELD SERVICE TECHNICAL MANUAL				Option or Designator
	12 Bit <input checked="" type="checkbox"/>	16 Bit <input checked="" type="checkbox"/>	18 Bit <input checked="" type="checkbox"/>	36 Bit <input checked="" type="checkbox"/>	LA30

Title LINE FEED PROBLEM				Tech Tip Number LA30-TT-11	
All	Processor Applicability	Author Carl Cline	Rev 0	Cross Reference	
X		Approval W. Cummins	Date 02/23/73		

The LA30 line feed problem is a result of the machine missing one or more line feeds and as a result overprint the previous line. ECO #71 was generated and kits are available from the Field Service Stockroom.

SUPPLEMENTAL ACTION TAKEN

ECO LA30 071

MCN _____

TECH TIP _____

OBSOLETE _____

Title SENSITIVE PAPER OUT SWITCH				Tech Tip Number LA30-TT-12	
All	Processor Applicability	Author Carl Cline	Rev 0	Cross Reference	
X		Approval W. Cummins	Date 02/26/73		

This problem causes the machine to either think it is out of paper when it isn't or that it has paper when it doesn't. The only adjustment provided is the clearance hole of the micro-switch, it therefore becomes necessary if the hole is not great enough to forceably bend the actuating arm.

COMPANY CONFIDENTIAL

Title <i>SETTING LEFT AND RIGHT MARGIN</i>						Tech Tip Number <i>LA 30-TT-13</i>	
Processor Applicability						Author <i>Carl Cline</i> Rev <i>0</i>	
All						Cross Reference	
x						Approval <i>W. Cummins</i> Date <i>02/26/73</i>	

When the left-hand margin is properly set, the right hand margin will be set automatically. To adjust the margins, proceed as follows:

1. Observe location of switch (left hand), to see if the lever on the switch will hit the carriage at the correct attitude and accuate the switch in the center of the 45° angle. See attached sketch for correct setting.
2. Prepare a length of paper from the LA30 paper supply by drawing in a reference line in pencil or ink 0.0750 ± 0.010 inches in from the left hand sprocket hole center line. (Figure 5-7)
3. Using this paper, the margin in the printer will be set correctly when the left edge of the character "E" printed in the first position after a carriage return coincides with the center of the reference line.
4. The position of the first character is adjusted by loosening the splined set screw on the drive pulley and then rotating the drive pulley on the shaft extension to correct the error found in step 3. Retighten set screw to at least 14 inches/pounds before testing.
5. If the above conditions cannot be met, it is probable that the left-hand margin switch is damaged, worn, or improperly mounted. Readjust or replace the switch and repeat steps 2 and 3.
6. CAUTION: Check to see if set screw on timing belt pulley is stripped or loose. This also causes similar problems as Step 4. If so retighten or replace.

CC:mt

COMPANY CONFIDENTIAL

digital	FIELD SERVICE TECHNICAL MANUAL				Option or Designator LA30
	12 Bit <input checked="" type="checkbox"/>	16 Bit <input checked="" type="checkbox"/>	18 Bit <input checked="" type="checkbox"/>	36 Bit <input checked="" type="checkbox"/>	

Title <i>SETTING LEFT AND RIGHT MARGIN (Continued)</i>				Tech Tip Number LA30-TT-13	
All Processor Applicability		Author <i>Carl Cline</i>	Rev <i>0</i>	Cross Reference	
<i>X</i>		Approval <i>W. Cummins</i>	Date <i>02/27/73</i>		

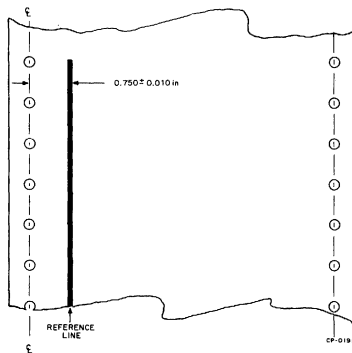
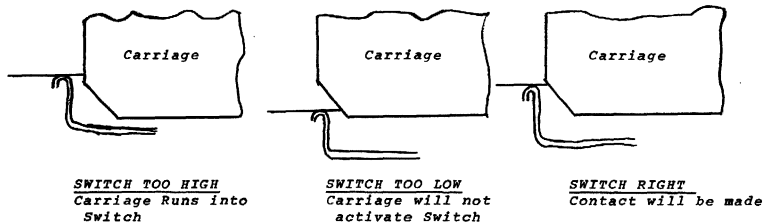

Figure 5-7 Checking Left Margin

COMPANY CONFIDENTIAL

Title <i>SETTING LEFT AND RIGHT MARGIN (Continued)</i>					Tech Tip Number <i>LA30-TT-13</i>	
All	Processor Applicability		Author <i>Carl Cline</i>	Rev <i>0</i>	Cross Reference	
X			Approval <i>W. Cummins</i>	Date <i>02/27/73</i>		

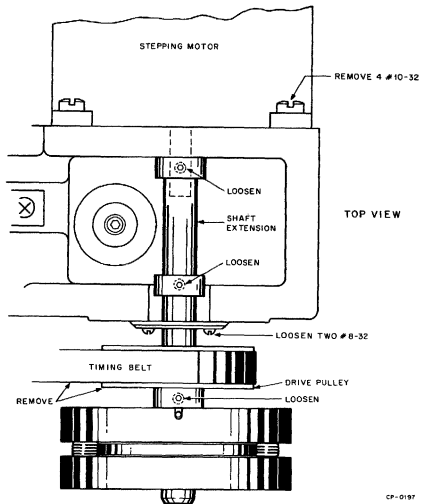

Figure 5-9 Stepping Motor Removal

COMPANY CONFIDENTIAL

digital	FIELD SERVICE TECHNICAL MANUAL				Option or Designator
	12 Bit <input checked="" type="checkbox"/>	16 Bit <input checked="" type="checkbox"/>	18 Bit <input checked="" type="checkbox"/>	36 Bit <input checked="" type="checkbox"/>	LA30

Title ADJUSTMENT PROCEDURE				Tech Tip Number LA30 TT-14	
All	Processor Applicability		Author C. Cline	Rev 0	Cross Reference
X			Approval W.E. Cummins	Date 5/31/73	G936

The G936 clock accelerator does not meet the 300 ms carriage return spec required by the LA30.

Correction: Add three potentiometers to adjust high speed ramp, low speed ramp and high speed running rate. (ECO G936-00002)

Following is the adjustment procedure required for setting these three pots.

1. Place the modified G936 on an extender board.
2. Stall the print head by switching motor circuit breaker "OFF" while unit is running.
3. Place the scope probe on S2 of G936 module. Depress head warning switch (second micro switch from left) and adjust R7 (100K bottom pot) to result in 3.0 milsec between pulses.

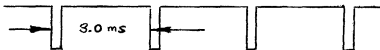

4. Release warning switch then adjust R4 (5K middle pot) for 550 usec between pulses.



5. Switch main frame power off. Adjust R15 (5K Top pot) fully clockwise. Turn on motor breaker then switch main frame power on. Trigger sweep on G936 S2 then place second probe on C2 + (2.2uf CAP) on G936; while unit is printing adjust R15 for a negative going ramp of 55.0 milsec.
6. Check time of PRINT INH L on M7710 (A12-S2) to be less than 300 milsec.

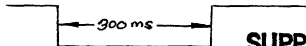

SUPPLEMENTAL ACTION TAKEN

- ECO G936-002
- MCN _____
- TECH TIP _____
- OBSOLETE _____

COMPANY CONFIDENTIAL

Title LA30 11 Family interconnections						Tech Tip Number LA30-TT-15	
All 11's	Processor Applicability				Author John Alston	Rev #	Cross Reference
					Approval B. Dimbat	Date 6/1/73	

1. Current Mode (20 ma)

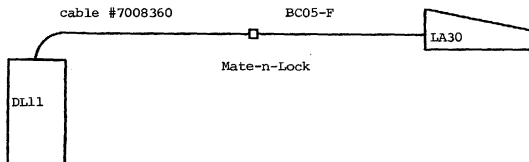

+XMIT	AA	(White)	5	5	(White)	7	REC +
-RET	KK	(BLK)	2	2	(Black)	3	RET -
+REC	K	(Green)	7	7	(Green)	5	XMIT +
-RET	S	(Red)	3	3	(Red)	2	RET -

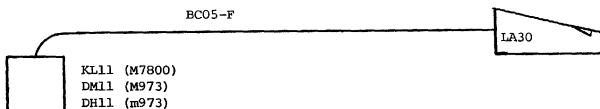

+XMIT	C1	5	(White)	7	REC +
-RET	D1	2	(Black)	3	RET -
+REC	J1	7	(Green)	5	XMIT +
-RET	M1	3	(Red)	2	RET -

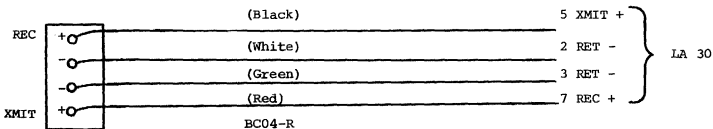

.DJ11 - H317 A Dist. Panel

COMPANY CONFIDENTIAL

digital	FIELD SERVICE TECHNICAL MANUAL				Option or Designator
	12 Bit <input checked="" type="checkbox"/>	16 Bit <input checked="" type="checkbox"/>	18 Bit <input checked="" type="checkbox"/>	36 Bit <input checked="" type="checkbox"/>	LA 30

Title LA30 11 Family Interconnections				Tech Tip Number LA30-TT-15	
All Processor Applicability		Author J. Alston	Rev g	Cross Reference	
11's		Approval B. Dimbat	Date 6/1/73		

2. EIA Level

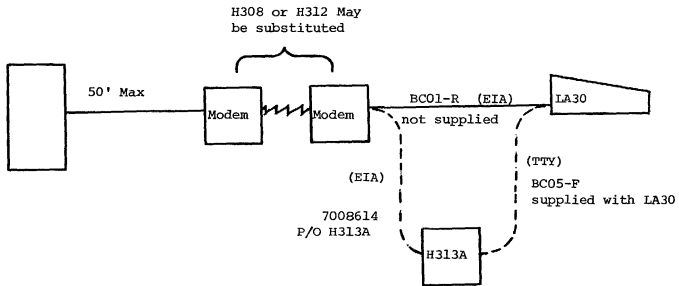

DL11 BC05-C (Supplied)
 DC11 BC01-R (Supplied)
 DM11 BC01-R (Supplied)
 DJ11 BC05-D (Not Supplied)

EIA to TTY
Level Converters

COMPANY CONFIDENTIAL

Title LA30 - LINE FEED ADJUSTMENT						Tech Tip Number LA30-TT#16	
All Processor Applicability				Author V. Erdekian		Rev 0	
X				Approval J. Sarasin		Date 12/20/73	
Cross Reference							

Appendix I

PROCEDURE FOR ADJUSTING LINE FEED SOLENOID

SUMMARY: Find a range of values within which the line feed solenoid operates properly (diagnostic test passes). Use the center of the range for the final adjustment.

DETAILED PROCEDURE

1. On line feed solenoid, loosen adapter locknut. (Index #79 in LA30 manual, figure A-1.)
2. With solenoid in rest position, rotate the solenoid armature (CCW as viewed from top) until the tooth of the pawl contacts the ratchet tooth. Mark a reference line on the solenoid and armature.
3. Back the armature off (CW) 3/4 turn and lock it in place with the locknut.
4. Run part 2 of the line feed quality test in the exerciser test* and note if it passes the test. If it does (see note at end of section). If it does not pass the test, then do the following:
 - a. Loosen locknut
 - b. Back armature (CW) 1/8 of a turn
 - c. Run diagnostic test

If it does operate properly this is the lower limit of your range; if not, keep testing at increments of 1/8 until you find the first place where it operates properly. (Note this as your lower limit.)

5. Having found your lower limit, at increments of 1/8 CW, apply the diagnostic test until it stops operating properly (this is the upper range of acceptance).

(Page 12 intentionally left blank)

PAGE 308	PAGE REVISION 0	PUBLICATION DATE March 1974
----------	-----------------	-----------------------------

digital	FIELD SERVICE TECHNICAL MANUAL				Option or Designator
	12 Bit <input type="checkbox"/>	16 Bit <input checked="" type="checkbox"/>	18 Bit <input checked="" type="checkbox"/>	36 Bit <input checked="" type="checkbox"/>	LA30
Title LA30 LINE FEED ADJUSTMENT				Tech Tip Number	LA30 TT#16
All	Processor Applicability	Author V Erdekian	Rev g	Cross Reference	
X		Approval J. Sarasin	Date 12/20/73		

6. Finally, adjust armature at the halfway distance between operating limits that were found.

NOTE: Turn armature back CCW at increments of 1/8th turns and do the diagnostic test until it is not operating properly (this is your lower limit now). Go to step 5 and continue.

*Note: Maindec 08 DHELLA-B, Decwriter (LA30) control-exerciser test. For an 11 system toggle in program given in Appendix III. The diagnostic for the 11 system is being updated to include the new test.

In a PDP-15 system use MAINDEC-15-DZLAA-B, LA30 diagnostic as follows:

1. Set ACS 03 and 05 = 1
Set ACS 15 = 1 if 300 baud
Set ACS 16 = 1 if LA30P
2. Start program at 202. When the line feed quality test begins, raise ACS 02 to lock onto this section, and proceed with your adjustments. (The LFQ test is preceded by 80 column margin and carriage return tests. Either of these may be aborted by typing "Control C").

Title										Tech Tip	
LA30 LINE FEED ADJUSTMENT										Number	
Processor Applicability										LA30-TT#16	
All										Author	Rev
X										V. Emekian	g
										Approval	Date
										J. Sarasin	12/20/73
										Cross Reference	

TECH. TIP

LA30 Line Feed (L/F) adjustment.

NOTE: This adjustment is for LA30's using one or two part paper.

First: Follow the procedure outlined in Appendix I for adjusting the L/F solenoid.

Second: If the L/F still does not operate correctly, follow the procedure outlined in Appendix II.

Third: If the L/F still does not operate correctly, change the L/F solenoid assembly, i.e. DEC Part Numbers:

12-11026
12-10473
12-10495
90-09061
12-10496
12-10342
90-06563

Note: Before putting the parts together check that part number 12-10473 (spring) fits over part number 90-09061 (nut) loosely. (At least .010" clearance.) Part number 90-09225 (mylar washer) is not part of the assembly. It has been taken out by ECO #71.

digital	FIELD SERVICE TECHNICAL MANUAL				Option or Designator
	12 Bit <input checked="" type="checkbox"/>	16 Bit <input checked="" type="checkbox"/>	18 Bit <input checked="" type="checkbox"/>	36 Bit <input checked="" type="checkbox"/>	LA30
Title LA30 - LINE FEED ADJUSTMENT				Tech Tip Number	LA30 TT#16
All	Processor Applicability	Author V. Erdikian	Rev 0	Cross Reference	
X		Approval J. Sarasin	Date 12/20/73		

Appendix II

PROCEDURE FOR CHECKING THE ELECTRICAL PORTION OF THE L/F SYSTEM.

Examine the signal on the terminals of the G381 module while local line feed switch is depressed.

Terminal

Waveform

Specification

G381-TB1

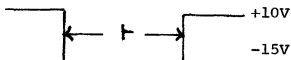

$t = 12$ to 18 msec.

G381-TB4

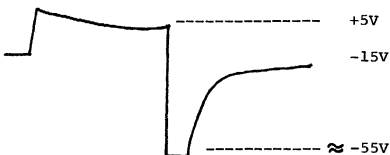

These waveforms indicate that the line feed solenoid is receiving the proper electrical signal.

Title						Tech Tip	
LA30 LINE FEED ADJUSTMENT						Number	
Processor Applicability						LA30 TT#16	
All						Author	Rev
X						V. Erdekian	g
						Approval	Date
						J. Sarasin	12/20/73
							Cross Reference

Appendix III

Toggle in the following program for an 11/05, 11/20 and 11/45.
 (This will serve as a test for line feed until the 11 diagnostic
 is updated).

<u>Location</u>	<u>Data</u>
0	012700
2	000030
4	012701
6	177564
10	010102
12	005722
14	005003
16	105711
20	100376
22	012712
24	000015
26	010005
30	006205
32	006205
34	006205
36	060500
40	010004
42	005304
44	100404
46	010405
50	005305
52	100773
54	000775
56	105711
60	100376
62	012712
64	000012
66	105711
70	100376
72	012712
74	000134
76	005203
100	022703
102	000040

PAGE 312	PAGE REVISION 0	PUBLICATION DATE
----------	-----------------	------------------

digital	FIELD SERVICE TECHNICAL MANUAL				Option or Designator
	12 Bit <input checked="" type="checkbox"/>	16 Bit <input checked="" type="checkbox"/>	18 Bit <input checked="" type="checkbox"/>	36 Bit <input checked="" type="checkbox"/>	LA30

Title LA30 LINE FEED ADJUSTMENT				Tech Tip Number TT#16	
All Processor Applicability				Author V.Erdekian	Rev 0
X				Approval J.Sarasin	Date 12/20/73
Cross Reference					

104 001735
106 000747

To run program:

- a. Load Address 0
- b. Start

The program will stay in a loop, until you halt.

Title LA-30 Special Tools				Tech Tip Number LA30 TT #17	
All Processor Applicability				Author Jerry Sarasin	Rev 0
X				Approval Chris Ball	Date 1-29-74
Cross Reference					

When attempting repair or adjustment, a special tool is needed. Lack of a bristol wrench will prevent any adjustment of the left hand margin or installation of the carriage stepping motor. The following bristol wrench has proven adequate, or a complete set can be ordered under the DEC part number.

DEC NUMBER
29-16131

BRISTOL NUMBER
DA-096

Title LA30 Voltage & Hertz Conversion Chart						Tech Tip Number LA30-TT-#18		
All X	Processor Applicability					Author Jerry Sarasin	Rev 0	Cross Reference
						Approval Chris Ball	Date 1-29-74	

LA30 VOLTAGE & HERTZ CONVERSION CHART
(CHANGES TO H735 POWER SUPPLY PER PRINT SET)

PRIMARY TERMINAL CONNECTIONS

LA30 CONFIGURATIONS

INPUT VOLTAGE JUMPERS LINE CONN.

+15 + 1Hz				
115V 60Hz	4-7, 5-2	4,5		PA-CA-EA
240V 60Hz	2-7	4,5		PB-CB-EB
115V 50Hz	4-8, 5-1	4,5		PC-CC-EC
240V 50Hz	1-8	4,5		PC-CD-ED

SECONDARY TERMINAL CONNECTIONS

OUT PUT CONN. JUMPERS POWER SUPPLY
W/RATINGS

*12-15-18	-	15-16.6 VDC 8A. 60Hz		PA-CA-EA
14-15-16	-	10-11.5 VDC 8A. 60Hz		PB-CB-EB
11-15-19	-	15-16.6 VDC 8A. 50 Hz		PC-CC-EC
13-15-17	-	10-11.5 VDC 8A. 50 Hz		PD-CD-ED
CAP. (2MF-660V) 10		60 Hz		PA-CA-EA-PB-CB-EB
CAP. (2MF-660V) 9		50 Hz		PC-CC-EC-PD-CD-ED

NOTE: For input voltages 200VAC and above replace 5AMP Circuit breaker (12-10191-1 with 2.5 AMP circuit breaker (12-10191-2).

PAGE 314	PAGE REVISION 0	PUBLICATION DATE January 1974
----------	-----------------	-------------------------------

digital	FIELD SERVICE TECHNICAL MANUAL				Option or Designator	
	12 Bit <input checked="" type="checkbox"/>	16 Bit <input checked="" type="checkbox"/>	18 Bit <input checked="" type="checkbox"/>	36 Bit <input checked="" type="checkbox"/>	LA30	
Title Conversion of LA30 Parallel to LA30 Serial					Tech Tip Number LA30 TT #19	
All X	Processor Applicability			Author Jerry Sarasin	Rev 0	Cross Reference
				Approval Chris Ball	Date 1-29-74	

CONVERSION OF LA30 PARALLEL TO LA30 SERIAL *

PARTS REQUIRED:

<u>PART NUMBER</u>	<u>DESCRIPTION</u>	<u>QTY</u>
74-9541	Serial Bezel	1
54-9914-2	Serial Switch Ass'y	1
M7389	Module	1
M7731	Module	1
M598	Module	1
M973	Module	1
BC05F-15	Cable	1
12-2116-1	Light	1
90-07129	Clip	1

PROCEDURE :

1. Remove Parallel Keyboard Bezel and Switch Ass'y from machine.
2. Remove Switch Assembly from Keyboard Bezel.
3. Pre-Assemble Serial Switch Ass'y to Serial Bezel using same hardware used on Parallel Switch Ass'y.
4. Install Serial Keyboard Bezel and Switch Ass'y onto base, using same hardware used on Parallel Ass'y.
5. Remove G8004 Module from Logic (Slot AØ8).
6. Insert M7389 Module into Slot A/B-20.
7. Insert M7731 Module into Slot A/R-19.
8. Insert M598 Module into Slot A-18.
9. Insert M973 Module into Slot B-18.
10. Insert one end of BC05F-15 Cable into M973 Module.

NOTE: The above procedure assumes that the parallel LA30 has the latest revision which is as follows:

1. New style Logic Hinge (90 degree bend on hinge that fastens to control box) (12-10908).
2. New style Rear Door accomodate new logic hinge (74-9491).
3. ECO #75 is installed in machine and logic to K rev.

* LA30PA-PB-PD to LA30CA-CB-CC-CD.

Title Conversion of LA30P to LA30E							Tech Tip Number LA30 TT #20		
All X	Processor Applicability						Author Jerry Sarasin	Rev 0	Cross Reference
							Approval Chris Ball	Date 1-29-74	

CONVERSION OF LA30P TO LA30E*

PARTS REQUIRED:

<u>PART NUMBER</u>	<u>DESCRIPTION</u>	<u>QTY</u>
74-9541	Serial Bezel	1
54-9914-2	Switch Ass'y	1
M7389	Module	1
M7731	Module	1
M594 (REV "B")	Module	1
M970	Module	1
BC01R-25	Cable	1

PROCEDURE:

1. Remove parallel keyboard bezel and switch ass'y.
2. Remove switch ass'y from keyboard bezel.
3. Pre-assemble serial switch ass'y to serial bezel using same hardware used on parallel switch ass'y.
4. Install serial keyboard bezel and switch ass'y to base.
5. Remove G8004 module from logic (A08).
6. Insert M7389 into slot A/B/-20.
7. Insert M7731 into slot A/B-19.
8. Insert M594 into slot A-18.
9. Insert M970 into slot B-18.
10. Insert one end of BC01R-25 into M970 module.

NOTE: The above procedure assume that the parallel LA30 has the following parts.

1. New logic hinge (12-10908).
2. New style door (74-9491).
3. ECO #75 installed in unit.

*LA30PA-PB-PC-PC to LA30EA-EB-EC-ED.

PAGE 316	PAGE REVISION 0	PUBLICATION DATE January 1974
----------	-----------------	-------------------------------

digital	FIELD SERVICE TECHNICAL MANUAL				Option or Designator
	12 Bit <input checked="" type="checkbox"/>	16 Bit <input checked="" type="checkbox"/>	18 Bit <input checked="" type="checkbox"/>	36 Bit <input checked="" type="checkbox"/>	LA30
Title Conversion of LA30 Serial to LA30 Parallel					Tech Tip Number LA30 TT #21
All x	Processor Applicability	Author Jerry Sarasin	Rev 0	Cross Reference	
		Approval Chris Ball	Date 1-29-74		

CONVERSION OF LA30 SERIAL TO LA30 PARALLEL*

PARTS REQUIRED:

<u>PART NUMBER</u>	<u>DESCRIPTION</u>	<u>QTY</u>
74-9542	Parallel Bezel	1
54-9914-1	Parallel Switch Ass'y	1
G8004	Module	1
12-2116-1	Light	1
90-07129	Clip	1

PROCEDURE:

1. Remove serial keyboard bezel and switch ass'y from unit using the same hardware used on the serial ass'y.
2. Remove switch ass'y from keyboard bezel.
3. Pre-assemble parallel switch ass'y to parallel keyboard.
4. Install parallel keyboard bezel and switch ass'y onto base.
5. Remove M7389, M7731, M598, M973, and BC05F-15 cable from unit.
6. Install G8004 module into Slot A08.

NOTE: The above procedure assumes that the serial unit has ECO #75 installed and the logic is up to K revision.

*LA30CA-CB-CC-CD to LA30PA-PB-PC0Pd.

Title Conversion of IA30C to IA30E						Tech Tip Number IA30 TT # 22				
All x	Processor Applicability					Author	Jerry Sarasin	Rev	0	Cross Reference
						Approval	Chris Ball	Date	1-29-74	

CONVERSION OF IA30C TO IA30E*

PARTS REQUIRED:

<u>PART NUMBER</u>	<u>DESCRIPTION</u>	<u>QTY</u>
M594 (REV "B")	Module	1
M970	Module	1
BC01R-25	Cable	1

NOTE: The above parts constitute an option called DF11A.

PROCEDURE:

1. Remove M598, M973, and BC05F15 cable from unit.
2. Insert M594, M970, and BC01R-25 into slots A-18, B-18, respectively.
3. Attach BC01R-25 to M970 Module.

*IA30CA-CB-CC-CD to IA30EA-EB-EC-ED.

PAGE 318	PAGE REVISION 0	PUBLICATION DATE January 1974
----------	-----------------	-------------------------------

digital	FIELD SERVICE TECHNICAL MANUAL				Option or Designator LA30
	12 Bit <input type="checkbox"/>	16 Bit <input checked="" type="checkbox"/>	18 Bit <input checked="" type="checkbox"/>	36 Bit <input checked="" type="checkbox"/>	

Title Instructions for Installing Dura Head on LA30 Decwriters				Tech Tip Number LA30 TT #23	
All X	Processor Applicability			Author Jerry Sarasin	Rev 0
				Approval Chris Ball	Date 1/31/74
					Cross Reference

SUBJ: INSTRUCTIONS FOR INSTALLING DURA HEAD ON
LA30 DECWRITERS

- On slot A5 (head cable connector M963), unsolder the 3 black wires. These wires connect to ground lugs on power supply.
- Two wires will be crimped together on the power supply end. These may, or may not both go to slot A5. One may go to the chassis, insure that the wire from the chassis physically remains connected. (Clip extra black wire if needed.) Remove the 3 black wires from the power supply to module slot A5.
- Install green wire from module A5, (any of the pins that a black wire was disconnected from will do), and run to the power supply +10V lug. Use the double spade lug included if necessary.
- On older LA30s, insure there is still enough clearance to close module logic rack without interfering with +10 lugs.
- Install new head in the same manner as old head. Use 1/2 inch screws and washers included. The new head is a different thickness.
- Adjust the head gap to .012", using feeler stock. The new head has a lip on both the top and bottom. Use caution to insure feeler stock is not on the lips. (see diagram 2)

-- NOTES --

digital	FIELD SERVICE TECHNICAL MANUAL				Option or Designator
	12 Bit <input checked="" type="checkbox"/>	16 Bit <input type="checkbox"/>	18 Bit <input type="checkbox"/>	36 Bit <input type="checkbox"/>	LAB 8 to LC8E

Title LAB 8 INSTALLATION NOTES					Tech Tip Number LAB 8-TT-1	
All	Processor Applicability			Author A. Newbery	Rev 0	Cross Reference
	8I			Approval W. Cummins	Date 7-31-72	

- 1) The Lab 8 systems are checked out "in-house" with the standard grid input intensity (Z) signal. If the customer has supplied his own scope, it may be a type which required a cathode input signal. The Lab-8 A/D logic can be modified to provide a cathode signal as follows:

Delete A22F to A21N ADD A22F to A21R

- 2) If you are running a test during which you expect to see a character or pattern on the screen, and only a raster is visible, it may be that the intensity control has been advanced too far. Best practice is to reduce brightness to minimum, then bring it up to the desired viewing level.
- 3) If the left diagonal (switch setting 1000 octal) generated by Maindec 8I-D6AA has curled ends, a lack of termination iss indicated. Two 33K OHM terminators (which are listed on the external component list) may be missing, install as follows:
- C25K to C25E (C25E is -10)
B25K to B25E (B25E is -10)
- 4) It should be noted that there are two errors concerning the VC8I in the "Small Computer Handbook". Voltage at terminal BS2 on the A607 module varies from 0 to +2, not 0 to -10. The reference voltage is -8, not -2.

Title LAB 8/E SOFTWARE PROBLEMS					Tech Tip Number LAB 8/E TT-1	
All	Processor Applicability			Author George Chaisson	Rev g	Cross Reference
	8E			Approval W. Cummins	Date 7-31-72	

PROBLEM: Recently software for the Lab-8E has been released from the Program Library and shipped to all customers. Two pieces of software in the software package have problems.

SOLUTION: 1. The Basic Averager DEC-LB-0603-PB needs a one word patch.

Location 7203 from 6530 to 6531.

2. The Time Interval Histogram DEC-LB-U42B-PB has a checksum in the paper tape. This tape must be replaced.

Title M8342 8 M8329 IOT SELECTION JUMPERS		Tech Tip Number LC8E-TT-1	
All X	Processor Applicability	Author L. Kral/J. Richards Rev A	Cross Reference LS8E-TT-1
		Approval W. Cummins Date 10.13.72	

Volume III of the 8E Maintenance Manual and the M8329 circuit schematic, Rev. C both have mistakes with the jumper numbering for device code selection. The board actually agrees with the drawing below.

The fault symptom will typically be either wrong sense of bits 5 or 6 in the decoded IOT, or MD bit 6 always constant on the omnibus.

The same mistakes have been carried over into the LS8E (M8342) control. The drawing below also applies exactly to the C.S.Rev. 0 of that board.

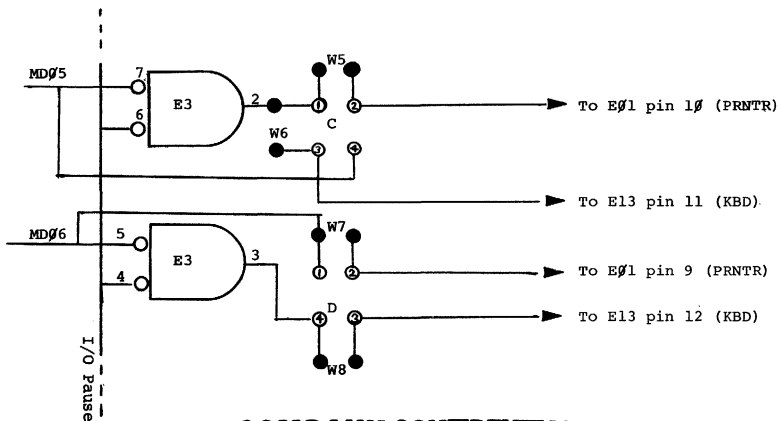

COMPANY CONFIDENTIAL

digital	FIELD SERVICE TECHNICAL MANUAL				Option or Designator
	12 Bit <input checked="" type="checkbox"/>	16 Bit <input type="checkbox"/>	18 Bit <input type="checkbox"/>	36 Bit <input type="checkbox"/>	LINC 8

Title LINC 8 CLAMP LOAD'S LOCATION AND USE					Tech Tip Number LINC 8-TT-1		
All	Processor Applicability				Author Steve Lamote	Rev A	Cross Reference
	L	I	N	C	8	Approval Dick Edwards	

A list of the unused clamp loads within the normal (basic) Linc-8 system has never been compiled in the past.

First, a word about the clamp load and it's uses. There are basically 3 types of clamp loads; 2 ma, 5 ma, and 10 ma, with flip-flops, singleshots and special purpose modules differing in load and drive capability.

The clamp, when driven to ground acts as a load, of it's given value, thus removing that value of driving capability from the circuit. Although, when the clamp is driven to -3 volts, it acts as a supply; the amount of supply per clamp is given in chart form later.

Each circuit in the Linc-8 needs 1 ma of input drive, and has an output capability of 18 ma, except for flip-flops and singleshots which have 17 ma's of output.

Adding a clamp will improve fall time and the -3 volt drive, but at a cost of the ground driving and noise immunity capability of the output circuit.

In conclusion; before adding a clamp load, take into account:

1. What logic level is needed on the output to be clamped?
2. How many circuits are already being driven by the output circuit?
3. If the output is ground, as a logical one, how much noise is tolerable to achieve the added drive.

COMPANY CONFIDENTIAL

Title					LINC-8 CLAMP LOAD'S LOCATION AND USE		Tech Tip Number		LINC-8-TT-#1	
All					Processor Applicability		Author		STEVE LAMOTTE	
					L		I		N	
					C		8		Approval	
					DICK EDWARDS		Date		01/23/73	
							Rev		A	
									Cross Reference	

MODULE	PINS WITH CLAMP LOADS	LOAD AT GROUND	DRIVE SUPPLIED AT -3 VOLTS
B1#4	H, M, S	1# ma	7.8 ma
B115	J, P, V	1# ma	7.8 ma
B171	F	9 ma	7 ma
S111	J, P, V	5 ma	3.5 ma
R3#3	H, F	1# ma	7.8 ma
W#2	D→V	2 ma	1.4 ma
W#5	D→V	5 ma	3.5 ma
W5#1	D, E	1# ma	7.8 ma

COMPANY CONFIDENTIAL

digital	FIELD SERVICE TECHNICAL MANUAL				Option or Designator
	12 Bit <input checked="" type="checkbox"/>	16 Bit <input type="checkbox"/>	18 Bit <input type="checkbox"/>	36 Bit <input type="checkbox"/>	LINC 8

Title LINC 8 CLAMP LOAD'S LOCATION AND USE				Tech Tip Number LINC 8-TT-1
All	Processor Applicability		Author Steve Lamotte Rev A	Cross Reference
			Approval <u>Dick Edwards</u> Date <u>01/23/73</u>	

UNUSED CLAMP LOADS

COMPANY CONFIDENTIAL

MODULE LOC.	TYPE MODULE	PIN	APPLICABLE ONLY IF OPTION
PA24	S111	P	
PA27	S111	J	
PA27	S111	P	
PA27	S111	V	
PA3Ø	S111	V	
PA36	W5Ø1	D	
PB23	S111	V	
PB29	S111	J	
PB32	S111	J	
PB32	S111	P	
PC28	S111	P	
PD24	S111	P	
PD27	S111	V	
PE27	S111	J	182
PE17	S111	P	182
PE17	S111	V	182
PE2Ø	S111	J	182
PE2Ø	S111	P	182
PE2Ø	S111	V	182
PE26	S111	J	182
PE26	S111	P	182
PE27	S111	P	182

Title		LINC-8 CLAMP LOAD'S LOCATION AND USE		Tech Tip Number		LINC-8-TT-01					
All	Processor Applicability						Author	STEVE LAMOTTE	Rev	A	Cross Reference
	L	I	N	C		8	Approval	DICK EDWARDS	Date	01/23/73	

MODULE LOC.	TYPE MODULE	PIN	APPLICABLE ONLY IF OPTION
PE34	S111	J	182
PE34	S111	P	182
PE35	S111	P	182
PF08	W501	D	KR01
PF29	S111	P	182
PF29	S111	V	182
PF31	S111	J	182
PF34	S111	J	182
PF34	S111	P	182
PH07	W002	V	
MA39	W005	N	
MA39	W005	↓	
MA39	W005	V	
ME10	S111	V	188
ME16	S111	P	
ME16	S111	V	
ME37	W005	T	
ME37	W005	↓	
ME37	W005	V	
MF01	S111	V	183
MF09	B104	M	188
MF09	B104	S	188
MF19	W501	D	
MH08	R303	H	
MH08	R303	F	

COMPANY CONFIDENTIAL

digital	FIELD SERVICE TECHNICAL MANUAL				Option or Designator
	12 Bit <input checked="" type="checkbox"/>	16 Bit <input type="checkbox"/>	18 Bit <input type="checkbox"/>	36 Bit <input type="checkbox"/>	LINC 8

Title LINC 8 LOADS LOCATION AND USE					Tech Tip Number LINC 8-TT-1	
All	Processor Applicability				Author <u>Steve Lamotte</u>	Rev <u>A</u>
					Approval <u>Dick Edwards</u>	Date <u>01/23/73</u>
						Cross Reference

MODULE LOC.	TYPE MODULE	PIN	APPLICABLE ONLY IF OPTION
MH11	R3Ø3	F	
MH11	R3Ø3	H	
MH19	S111	P	
MH19	S111	V	
MJ18	S111	P	
MJ23	S111	J	
MJ23	S111	P	
MJ27	S111	J	
MJ27	S111	V	
LA28	wØØ5	T	
LA28	wØØ5	↓ V	
LA34	wØØ5	N	
LA34	wØØ5	↓ V	
LDØ2	B115	J	
LDØ2	B115	P	
LDØ2	B115	V	
LEØ3	B115	J	183
LEØ3	B115	V	183

COMPANY CONFIDENTIAL

Title Incorrect Cable Listings in the Linc-8					Tech Tip Number LINC-8-TT-2		
All	Processor Applicability				Author	Rev 0	Cross Reference
	12	18			Approval H. LONG	Date 8-17-72	

Problem: Incorrect cable listings in the LINC-8

Since the Linc -8 was first introduced there has been a problem with the cable listings. The prints of the PDP-8 section give standard PDP-8 cable connections, which for the Linc-8 are totally useless. The PDP-8 section is the only part in error.

Solution: Attached is a complete list of the cables of the Linc-8 their slot positions, part numbers, length and type of cable, This list complements the list in the Maintenance Manual Vol 2 on page 72 and 73 (print #D-IC-LINC 8-0-5 and #D-IC-LINC-8-0-6 I/O cables) both these prints and these attached sheets should be consulted before coming to the conclusion that a cable is missing or a wiring error has been found.

<u>Notes</u>	<u>Type of Cable</u>	<u>Slot Positions</u>	<u>Length-</u>	<u>Part Number</u>
#1	W034-W035	MA37 - PC01	50"	74-5559
#1	W034-W034	MA38 - PD01	52"	74-05554-10
#1	W034-W034	ME36 - PE01	70"	74-05554-5
	W034-W034	MF36 - PF01	30"	74-05554-8
		MA36 - LA01	10"	74-05554-1
		MD40 - LD01	10"	
		ME40 - LE01	10"	
		MF40 - LF01	10"	
		MH38 - LH03	10"	74-05554-1
		MJ39 - LJ02	10"	
		MJ40 - LJ01	10"	
		LH59 - PH02	10"	
		LH40 - PH01	10"	
		LJ39 - PJ02	10"	
	W034-W034	LJ40 - PJ01	10"	74-05554-1
	W031-W031	MH39 - LH02	12"	74-05552-2
		MH40 - LH01	12"	
		MJ37 - LJ04	12"	
		MJ38 - LJ03	12"	
		LJ38 - PJ03	12"	
	W031-W031	LH38 - PH03	12"	74-05552-2
	W034-W034	LA02 - PA01	52"	74-05554-10
	W034-W034	LA03 - PB01	52"	74-05554-10
	W033-W033	LA31 - DB36	80"	74-055-3-5
		IND01 - PC38	80"	
		IND02 - PB38		

COMPANY CONFIDENTIAL

DIGITAL EQUIPMENT CORPORATION

digital	FIELD SERVICE TECHNICAL MANUAL				Option or Designator
	12 Bit <input checked="" type="checkbox"/>	16 Bit <input type="checkbox"/>	18 Bit <input type="checkbox"/>	36 Bit <input type="checkbox"/>	LINC 8

Title LINC 8 DIAGNOSTICS					Tech Tip Number LINC 8-TT-3		
All	Processor Applicability				Author Steve LaMotte	Rev \emptyset	Cross Reference
	L8				Approval Dick Edwards	Date 01/25/73	

Recently there has been a rash of outages and problem reports on the linc 8. The common complaint being that all diagnostics run but customer software fails. After closer examination, we find that not all linc diagnostics have been run, only sudsy. The sudsy tape contains numerous other diagnostics which are necessary to test the linc section. Among these are St. Louis (BLK #5 $\emptyset\emptyset$), INSTST, MTPPTST, etc., which are listed and controlled by guide while running under Progofop.

/mt

Title LINC 8 MEMORY CURRENT DISTORTION					Tech Tip Number LINC 8-TT-4		
All	Processor Applicability				Author Steve LaMotte	Rev \emptyset	Cross Reference
	L8	8			Approval Dick Edwards	Date 01/25/73	

Due to different engineering specifications between the T2 \emptyset 51 and T2 \emptyset 71 pulse transformers, cards in the memory control (G2 \emptyset 8, G2 \emptyset 9 and G6 \emptyset 3) must not be intermixed.

Mixing of these transformers will cause a definite increase in the current waterfall effect. This change occurs because the T2 \emptyset 71 is faster than the T2 \emptyset 51.

/mt

COMPANY CONFIDENTIAL

Title						Tech Tip				
REWIRING OF MEMORY PANEL						Number LINC 8-TT-5				
All	Processor Applicability					Author	Steve Lamotte	Rev	g	Cross Reference
	L8					Approval	Burt Bevers	Date	02/08/73	

This wiring scheme reduces noise on the sense amp power on slice voltage levels. It also removes the difference in voltage levels between the odd and even sense amp input lines MA25E - MB25E. These lines have been noted to have as much as .5 volts difference in voltage.

After installation of this tech tip, you may notice changes in the read/write and inhibit current waveshapes.

A few pin connections have been changed to facilitate shorter wire runs. All wires are to be laid as to avoid the R/W and inhibit current windings, (yellow/black twisted pairs), found in the MC and MD memory racks. Most changes will be to run wiring along the MD-ME wirelay from the MC-MD wirelay or from diagonal crossing of the inhibit winding area. After wiring change is incorporated, most wires will (1) vertically run between MD and ME racks and (2) horizontally along module 30 row (MA30, MB30, MC30 and MD30).

A future Linc ECO will add a diode between "Memory Start" circuitry and "Read (1)" circuitry. This change removes unnecessary loading from the "Memory Start" logic and cable noise from the "Read (1)" logic. This reduction of noise on "Read" causes less waterfall effect on the "Read" current waveshape.

Thus when this Tech Tip and future ECO is installed, a change in current waveshape can be anticipated as follows:*

Read/Write Current

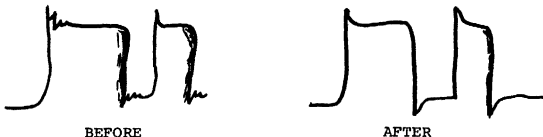

- (1) Reduced waterfall effect on Read Current
- (2) Less ringing - but more distinct overshoot.

COMPANY CONFIDENTIAL

DIGITAL EQUIPMENT CORPORATION

digital	FIELD SERVICE TECHNICAL MANUAL				Option or Designator
	12 Bit <input checked="" type="checkbox"/>	16 Bit <input type="checkbox"/>	18 Bit <input type="checkbox"/>	36 Bit <input type="checkbox"/>	LINC-8

Title					REWIRING OF MEMORY PANEL (Continued)		Tech Tip Number		LINC 8-TT-5		
All		Processor Applicability			Author		Steve Lamotte		Rev		Ø
I.8					Approval		Burt Beyers		Date		02/08/73
Cross Reference											

INHIBIT CURRENT

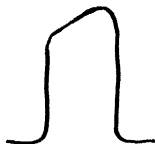

BEFORE



AFTER

- (1) Much sharper waveshape
- a. With less rounding of leading edge and
 - b. level upper limit instead of slope.

* NOTE: These waveshapes will not be so distinct a change in most systems (show ideal condition).

Make all deletions first when installing:

(Continued on next page)...

COMPANY CONFIDENTIAL

Title						REWIRING OF MEMORY PANEL (Continued)		Tech Tip Number		LINC 8-TT-5			
All		Processor Applicability				Author		Steve Lamotte		Rev		0	
L8						Approval		B. Beyers		Date		02/08/73	
												Cross Reference	

<u>SIGNAL NAME</u>	<u>FROM PIN</u>	<u>TO PIN</u>	<u>COMPONENTS</u>	<u>ADD</u>	<u>DEL</u>
Write (B)	MC16T	MC15D			X
Write (B)	MC16T	MD15D			X
Read (B)	MC16J	MC15E			X
Read (B)	MC16J	MD15E			X
MA 3 (1)	MD094	MD084		X	X
MA 3 (1)	MD084	MB35R			X
MA 3 (1)	MD094	MC16E			X
MA 11 (0)	MD15T	MD34F			X
MA11 (0)	MD15T	MC37V			X
Strobe	MD20N	MB25L			X
T1	MC20R	MA34V			X
T1	MC20R	MD30D			X
Slice	MA25H	MB25H			X
Slice Return	MA25M	MB25M			X
+10V	MA25A	MH13P			X
+10V	MB25A	MJ13H			X
-15V	MA25B	MH13T			X
-15V	MB25B	MJ13K			X
+10V	MB25D	MH13A			X
+10V	MH13P	MH13R		X	X
-15V	MJ13K	MJ13L		X	X

COMPANY CONFIDENTIAL

DIGITAL EQUIPMENT CORPORATION

digital	FIELD SERVICE TECHNICAL MANUAL				Option or Designator
	12 Bit <input checked="" type="checkbox"/>	16 Bit <input type="checkbox"/>	18 Bit <input type="checkbox"/>	36 Bit <input type="checkbox"/>	LINC 8

Title				REWIRING OF MEMORY PANEL (Continued)		Tech Tip Number		LINC 8-TT-5	
All		Processor Applicability		Author Steve Lamotte		Rev 0		Cross Reference	
L8				Approval Burt Bevers		Date 02/08/73			

MAKE DELETIONS FIRST WHEN INSTALLING

<u>SIGNAL NAME</u>	<u>FROM PIN</u>	<u>TO PIN</u>	COMPONENTS	ADD	DEL
+10V	MA29A	MH13P			X
+10V	MB29A	MJ13H			X
-15V	MA29B	MH13T			X
-15V	MB29B	MJ13K			X
+10V	MB30D	MH13A			X

COMPANY CONFIDENTIAL

Title						REWIRING OF MEMORY PANEL (Continued)		Tech Tip		Linc 8-TT-5	
All						Processor Applicability		Author		Steve Lamotte	
								Rev		0	
L8								Approval		B. Bevers	
								Date		02.08.73	
										Cross Reference	

MAKE ALL DELETIONS FIRST WHEN INSTALLING

<u>SIGNAL NAME</u>	<u>FROM PIN</u>	<u>TO PIN</u>	<u>COMPONENTS</u>	<u>ADD</u>	<u>DEL</u>
Write (B)	MD12D	MD09D	Avoid R/W wind	X	X
Read (B)	MD12E	MD09E	Avoid R/W wind	X	X
MB (0)	MC21H	MC23D	Avoid Inhibit	X	X
MA 5 (1)	MD09S	MC33R	Avoid Inhibit	X	X
MA 7 (1)	MC15V	MC35R	Avoid Inhibit	X	X
MA 8 (1)	MC15S	MD31R	Avoid Inhibit	X	X
Write (B)	MC16T	MD15D	4.7 resistor	X	
Write (B)	MC15D	AD15D	wire	X	
Read (B)	MC15E	MD15E	wire	X	
Read (B)	MC16J	MC15E	4.7 resistor	X	
MA 3 (1)	MD094	MB35R		X	
MA 3 (1)	MB35R	MC36E		X	
MA 11 (0)	MD15T	MC3TV		X	
MA 11 (0)	MC37V	MD34F		X	
Strobe	MD20N	MB30L		X	
T1	MC20R	MA34V		X	
T1	MA34V	MD30D		X	
Slice	MA31H	MB31H		X	
Slice Return	MA31M	MB31M		X	

COMPANY CONFIDENTIAL

DIGITAL EQUIPMENT CORPORATION

digital	FIELD SERVICE TECHNICAL MANUAL				Option or Designator
	12 Bit <input checked="" type="checkbox"/>	16 Bit <input type="checkbox"/>	18 Bit <input type="checkbox"/>	36 Bit <input type="checkbox"/>	LINC 8

Title REWIRING OF MEMORY PANEL (Continued)				Tech Tip Number LINC 8-TT-5	
All Processor Applicability		Author Steve Lamotte	Rev 0	Cross Reference	
L8		Approval B. Beyers	Date 02.08.73		

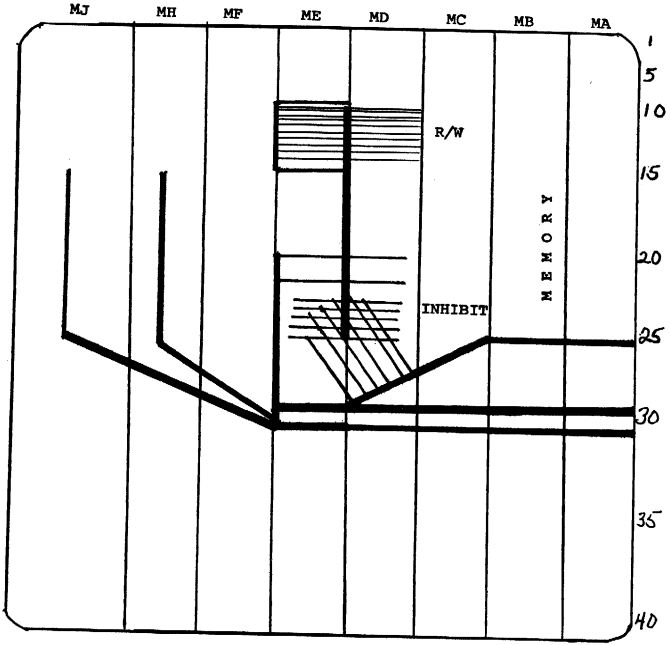

Wiring layout should follow this rough drawing

COMPANY CONFIDENTIAL

Title		LINC TAPE MAINTENANCE - UNIT SWITCH				Tech Tip		LINC 8-TT-6	
All		Processor Applicability		Author Steve Lamotte		Rev 0		Cross Reference	
L8				Approval B. Beyers		Date 02.08.73			

This switch is useful in the maintenance of the Linc Tape. As it can easily accommodate the testing of tape unit 1, with normal Linc diagnostics.

1. PARTS

<u>Description</u>	<u>Quantity</u>	<u>DEC Part Number</u>
DPDT Switch	1	12-04816
9 Pin Cannon Plug	1	12-04648
4 Connector Cable	4 feet	19-07706

CANNON PLUG:

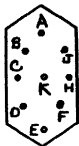

DPDT SWITCH:

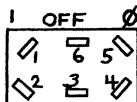

Plug Jumpers E-F
H-J

Switch Jumpers 1-4
2-5

Plug - Cable - Switch

A	GRN	6
B	WHT	3
C	BLK	1
D	RED	2
K	Open Pin	

Note: Insure plug hood is on cable correctly before soldering cable to Plug Terminals.

COMPANY CONFIDENTIAL

DIGITAL EQUIPMENT CORPORATION

digital	FIELD SERVICE TECHNICAL MANUAL				Option or Designator
	12 Bit <input checked="" type="checkbox"/>	16 Bit <input type="checkbox"/>	18 Bit <input type="checkbox"/>	36 Bit <input type="checkbox"/>	LINC 8

Title LINC 8- CLAMP LOAD LISTING				Tech Tip Number LINC 8-TT-7		
All	Processor Applicability			Author Steve Lamott	Rev 0	Cross Reference
	L8			Approval Beyers	Date 02.08.73	

A listing of the unused clamp loads within the normal (basic) Linc-8, has never been compiled in the past.

First, a word about the clamp load and its uses. There are basically 3 types of clamp loads - 2ma, 5ma and 10 ma with singleshots and flip-flops being of a special type.

The clamp, when driven to ground acts as a load of its given value, thus removing that value of driving capability from the circuit. Although when the clamp is driven to -3 volts, it acts as a supply - 2 ma will supply 1.4 ma, 5 ma will supply 3.5ma and 10 ma will supply 7.8 ma at -3 volts.

Each circuit in the Linc-8 needs 1 (one) ma as an input from $\bar{\phi}$ to -3 volts, and has an 18 ma output driving capability, except flip-flops and single shots which have 17 ma's output.

In conclusion, adding a clamp will improve fall time and -3 volts driving capability, but at a cost of the ground driving and noise immunity capability of the output circuit. So before adding a clamp load, take into account -

1. What logic level is (active) needed on the output to be clamped.
2. How many circuits are already being driven by the output circuit.
3. If the output is ground (as a logical one), how much is to be labeled to achieve the added drive.

MODULE TYPE	PINS W/CLAMP LOAD	LOAD @ GND	DRIVE SUPPLY at -3 Volts
S111	J,P,V	5MA	3.5MA
R303	H,P	10MA	7.8MA
B104	H,M,S	10MA	7.8MA
B115	J,P,V	10MA	7.8MA
* B171	F	9MA	7 MA
W002	D thru V	2MA	1.4MA
W005	D thru V	5MA	3.5MA
W501	D,E	10MA	7.8MA

COMPANY CONFIDENTIAL

Title LINC-8 CLAMP LOAD LISTING (Continued)						Tech Tip Number LINC 8-TT-7		
All		Processor Applicability				Author S. LaMotte Rev #		Cross Reference
L8						Approval B. Beyers Date 02/08/73		

Module <u>Loc</u>	Module <u>Type</u>	Pin	*Comments
PA24	S111	P	
PA27	S111	J	
PA27	S111	P	
PA27	S111	V	

PA30	S111	V	
PA36	W501	D	
PB23	S111	V	
PB29	S111	J	

PB32	S111	J	
PB32	S111	P	
PC28	S111	P	
PD24	S111	P	

PD27	S111	V	
PE17	S111	J	182
PE17	S111	P	182
PE17	S111	V	182

PE20	S111	J	182
PE20	S111	P	182
PE20	S111	V	182
PE26	S111	J	182

COMPANY CONFIDENTIAL

digital	FIELD SERVICE TECHNICAL MANUAL				Option or Designator
	12 Bit <input checked="" type="checkbox"/>	16 Bit <input type="checkbox"/>	18 Bit <input type="checkbox"/>	36 Bit <input type="checkbox"/>	LINC 8

Title LINC 8 CLAMP LOAD LISTING (Continued)				Tech Tip Number LINC 8-TT-7		
All	Processor Applicability			Author Steve Lamotte	Rev 0	Cross Reference
	1.8			Approval B. Beyers	Date 02/08/73	

<u>Module Loc</u>	<u>Module Type</u>	<u>Pin</u>	<u>*Comments</u>
PE26	S111	P	182
PE27	S111	P	182
PE34	S111	J	182
PE34	S111	P	182
PE35	S111	P	182
PF08	W501	D	KR01

PF29	S111	P	182
PF29	S111	V	182
PF31	S111	J	182

PF34	S111	J	182
PF34	S111	P	182
PH07	W002	V	Linc Interface
PJ21	S111	V	FPP12

MA39	W005	N	All Pins N to V
MA39	W005	V	
ME10	S111	V	188

COMPANY CONFIDENTIAL

Title						LINC 8 CLAMP LOAD LISTING (Continued)		Tech Tip Number		Linc 8-TT-7					
All		Processor Applicability				Author		Steve Lamotte		Rev		0		Cross Reference	
L8						Approval		B. Beyers		Date		02/08/73			

<u>MODULE LOCATION</u>	<u>MODULE TYPE</u>	<u>PIN</u>	<u>COMMENTS*</u>
ME16	S111	P	
ME16	S111	V	
ME37	W005	T	
ME37	W005	U	
ME37	W005	V	
MF01	S111	V	183
MF09	B104	M	188
MF09	B104	S	188
MF19	W501	D	
MH08	R303	H	Linc Tape
MH08	R303	F	Linc Tape
MH11	R303	H	Linc Tape
MH11	R303	F	Linc Tape
MH19	S111	P	Linc Tape
MH19	S111	V	Linc Tape
MJ18	S111	P	Linc Tape
MJ23	S111	J	Linc Tape
MJ23	S111	P	Linc Tape
MJ27	S111	J	Linc Tape
MJ27	S111	V	Linc Tape
LA28	W005	T	
LA28	W005	U	
LA28	W005	V	

COMPANY CONFIDENTIAL

DIGITAL EQUIPMENT CORPORATION

digital	FIELD SERVICE TECHNICAL MANUAL				Option or Designator
	12 Bit <input checked="" type="checkbox"/>	16 Bit <input type="checkbox"/>	18 Bit <input type="checkbox"/>	36 Bit <input type="checkbox"/>	LINC 8

Title LINC 8 CLAMP LOAD LISTING (Continued)				Tech Tip Number	LINC 8-TT-7
All	Processor Applicability		Author Steve Lamotte	Rev 0	Cross Reference
L8			Approval B. Beyers	Date 02/08/73	

<u>MODULE LOCATION</u>	<u>MODULE Type</u>	<u>PIN</u>	<u>COMMENTS*</u>
LA34	W005	N	All Pins N to V
LA34	W005	V	
LD02	B115	J	
LD02	B115	P	
LD02	B115	V	
LE03	B115	J	183
LE03	B115	V	183
DB18	W501	E	Data Terminal
DB19	R111	P	Panel 1 Sec.
DB19	R111	V	Clock

Title LINC-8 A/D NOISE & COUPLING				Tech Tip Number	LINC-8-TT-8
All	Processor Applicability		Author S. LaMotte	Rev	Cross Reference
L-8			Approval Larry Lewis	Date 5/2/74	

Linc-8 A/D channels 10-17 have a tendency to crosstalk thru, and/or pick up noise from, the A/D power system. By adding bypass capacitors to the + and - 5 vdc power regulator outputs, in the data terminal panel, most of the problem can be eliminated.

ADD

<u>Component</u>	<u>From</u>	<u>To</u>	<u>Signal</u>	<u>Part #</u>
6.8 microf 35vdc	DB31V (+)	DB31C (-)	+ 5vdc	10-05306
6.8 microf 35vdc	DB31U (-)	DB30C (+)	- 5vdc	"

COMPANY CONFIDENTIAL

-- NOTES --

digital	FIELD SERVICE TECHNICAL MANUAL				Option or Designator
	12 Bit <input checked="" type="checkbox"/>	16 Bit <input checked="" type="checkbox"/>	18 Bit <input checked="" type="checkbox"/>	36 Bit <input checked="" type="checkbox"/>	LK01

Title KEYBOARD SHORTS CAUSED BY PAPERCLIPS, ETC.				Tech Tip Number LK01-TT-1	
All	Processor Applicability			Author Davis/Barnett	Rev 0
X				Approval W.Cummins	Date 11/20/72
					Cross Reference

Exposed foil etch on keyboard becomes shorted by staples and/or paperclips, etc; resulting in permanent damage to keyboard assembly.

To reduce or eliminate the problem cover the exposed etch with paper stock or foam rubber and tuck the material under the top row of keys. Then tape material to board.

Title LK01 MAINTENANCE CHECK				Tech Tip Number LK01-TT-2	
All	Processor Applicability			Author J.Parker	Rev 0
X				Approval W. Cummins	Date 8/7/73
					Cross Reference VT05&LA30 GT40

This procedure is designed to give the field engineer quick check and repair hints in repairing LK01 keyboards on site. The procedure must be used in conjunction with the keyboard schematics A-CS-54-9945-0-1 (DEC) or A-CS-30-10166-0-0 (vendor).

IC's Y1, Y2, W1 to W3 are numbered with Y1 and W1 on the left side of the keyboard as you face it installed. Reference Fig 1-1.

1. Broken key caps, shafts or springs
2. Double characters or double strobe

Replace with a new part

Probably dielectric or Rom problem. Depress problem key or keys. Placing a scope probe on pin 16 of the Rom. Vibrate the key while it's depressed. If more than one strobe appears on the scope or a character is typed out, a dielectric or Rom problem exists for that key. First change the Rom, then if not repaired remove all rows of keys and clean the whole board with a dry brush. Spray the dielectric (green area only) with a clear acrylic krylon spray paint to be purchased locally, or by DEC #49-01135. Spray on two moderate coats and allow to dry per instructions on the paint can. Reassemble for retest. Do not type until paint is thoroughly dry.

COMPANY CONFIDENTIAL

Title						Tech Tip	
LKO1 MAINTENANCE CHECK						Number LKO1-TT-2	
All Processor Applicability			Author	Rev	Cross Reference		
			J. Parker	d	VT05&LA30		
			Approval	Date	GT40		
			W. Cummins	8/7/73			

- | | |
|--|--|
| 3. No control key function | Check pin 5 of the Rom for a low to high transition when CTRL key is depressed. If signal is OK, change ROM. No signal, proceed to check input pins 9 & 10 of W1 (7408). Depress CTRL key, the level will change from a high to low. No change indicates a bad transistor. If transition exists trouble shoot per schematic, W1 pin 8 to Y1 pin 3 to Y1 pin 4. |
| 4. No shift key | Works identical to the control key except check pin 4 of the ROM and follow the schematic for the associated I.C. numbers and pins. |
| 5. Check for clock frequency | Check pin 40 of the ROM (DEC #21-11047) No clk or wrong freq. change ROM. |
| 6. Check plus 5 volt at pin 20 of the ROM | No voltage: Check +5V input to the keyboard at pin Y of the Berg Conn. No input voltage check source. Input voltage OK but no +5V swap keyboard. |
| 7. Check key strobe | Pin 16 of the ROM output is a high (+5V). Depressing any key except shift or control will generate key strobe low (gnd). No strobe at this point for all keys, change the ROM. No strobe for a particular key change the transistor. (DEC 15-10948 NPN).
The key transistors are located along side its associate key and key pad. |
| 8. No strobe for any character but OK at ROM pin 16. | Trouble shoot per schematic checking for strobe at W1 (7408) input pins 4 & 5 output pin 6; then to W3 (7408) input pins 13 & 12 output pin 11 and lastly at Y1 Pin 8, or swap the keyboard. |
| 9. Dead or Intermittent Key Functions | Check with a scope the X/Y line decoding for your particular problem key or keys per fig 1-1. Most likely solution will be; replace the key transistor or the ROM. One of these solutions will fix most dead or intermittent key problems. |

COMPANY CONFIDENTIAL

digital	FIELD SERVICE TECHNICAL MANUAL				Option or Designator
	12 Bit <input type="checkbox"/>	16 Bit <input checked="" type="checkbox"/>	18 Bit <input checked="" type="checkbox"/>	36 Bit <input checked="" type="checkbox"/>	LK01-TT-2

Title					Tech Tip	
LK01 MAINTENANCE CHECK					Number LK01-TT-2	
All	Processor Applicability			Author	Rev	Cross Reference
				J. Parker	0	
			Approval	Date		GT40
			W. Cummins	8/7/73		

10. Check the oscillator voltage - The voltage can be checked at pin 9 of the I.C. plug. Reference Fig 1-1. No oscillation swap keyboard.

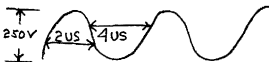

11. Check ROM Voltage (-12V)

Check -12V ($\pm 1.5V$) at pin 18 of the ROM. Ref. Fig 1-1. No voltage or not within range; swap keyboard.

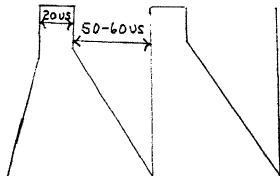

COMPANY CONFIDENTIAL

Title LK01 MAINTENANCE CHECK (CONT.)						Tech Tip Number LK01-TT-2	
All Processor Applicability			Author J. Parker		Rev 0		Cross Reference VT05 & LA30
			Approval W. Cummins		Date 8/7/73		GT40

X-Y COMBINATIONS FOR LK01 KEYS

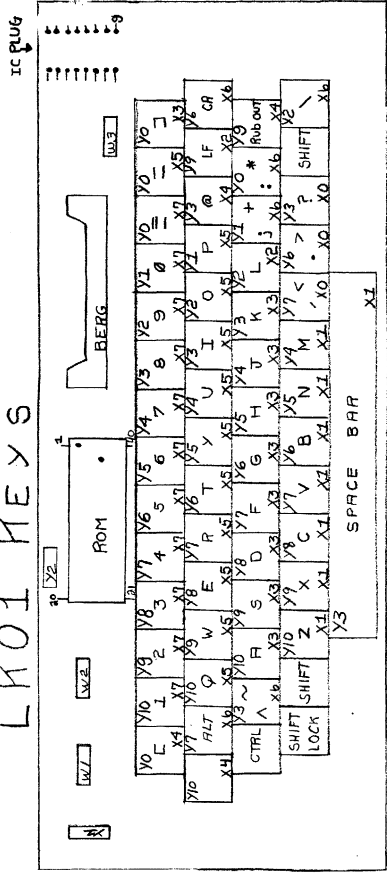

DEC 21-11047 ROM

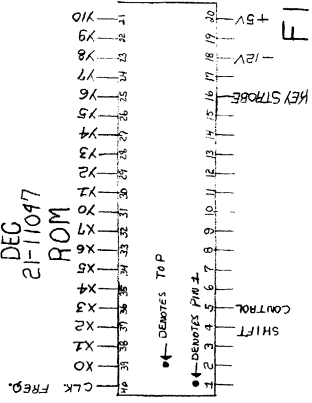

FIG. 1-1

COMPANY CONFIDENTIAL

CPL

digital	FIELD SERVICE TECHNICAL MANUAL				Option or Designator
	12 Bit <input checked="" type="checkbox"/>	16 Bit <input checked="" type="checkbox"/>	18 Bit <input checked="" type="checkbox"/>	36 Bit <input checked="" type="checkbox"/>	LK01

Title LK01 KEYBOARDS				Tech Tip Number LK01-TT-3	
All	Processor Applicability			Author Al Mathews	Rev g
X				Approval Lou Nay <i>LN</i>	Date 10-24-73
					Cross Reference

Some intermittent keyboard problems which affect only one or two keys are caused by small metal fragments (apparently manufacturing debris) which become embedded in the dielectric coating which covers the circuit etch on the keyboard. When the key is depressed, the metal plate on the underside of the key pushes the conductive fragments through the dielectric, contacting the keypads of the etch associated with that key causing D.C. coupling and noise where only A.C. coupling is desired.

The solution of course is to remove the particles but keep in mind that well embedded particles are difficult to remove.

COMPANY CONFIDENTIAL

-- NOTES --

digital	FIELD SERVICE TECHNICAL MANUAL				Option or Designator
	12 Bit <input checked="" type="checkbox"/>	16 Bit <input type="checkbox"/>	18 Bit <input type="checkbox"/>	36 Bit <input type="checkbox"/>	LK01-R

Title				Tech Tip		LK01R	
NUMERIC KEYPADS				Number		TT-1	
All		Processor Applicability		Author		Rev	
8E				John Woelbern		0	
				Approval		Date	
				B. Lawrence		8/13/74	
				Cross Reference			
				DS300-TT-2			

The light grey key caps for the mechanical keyboard, LK01R, have been assigned the following part number:

98-89578-B8 (Set of 10)

NOTE: These are not interchangeable with the ones used on the LK01 Keyboard (P/N 98-89148-8-74).

-- NOTES --

digital	FIELD SERVICE TECHNICAL MANUAL				Option or Designator LP01
	12 Bit <input checked="" type="checkbox"/>	16 Bit <input checked="" type="checkbox"/>	18 Bit <input checked="" type="checkbox"/>	36 Bit <input checked="" type="checkbox"/>	

Title NOISE PROBLEM ON DATA PRODUCTS LINE PRINTER				Tech Tip Number LP01-TT-1	
All Processor Applicability		Author Bill Freeman	Rev 0	Cross Reference	
<input checked="" type="checkbox"/>		Approval Bill Cummins	Date June 1		

The AS13 module used in the 231 μ and 241 μ line printers manufactured by Data Products have spare gates used on the transducer amp which are prone to pick up noise. Pins 5 and 6 on the 21 μ 1, 22 μ 1 and 23 μ 1 I.C.'s should be tied to ground. (Module Pin 2 or 6 μ).

/mt

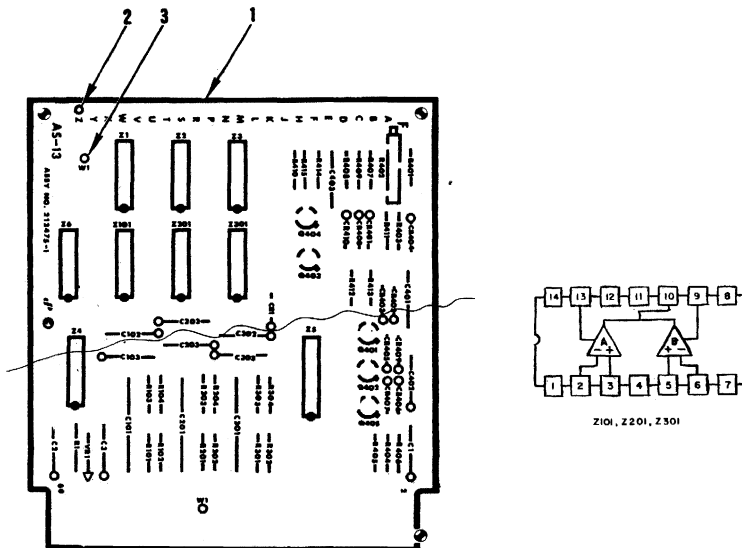

COMPANY CONFIDENTIAL

Title LP01/LP02 HAMMER BANK MAGNETS						Tech Tip Number LP01-TT-2		
All	Processor Applicability					Author D. Oldham	Rev 0	Cross Reference
X						Approval H. Long	Date 6/6/72	

When replacing hammers be extremely careful - do not exert stress on the permanent magnets either side of the hammer being replaced because these magnets may break away from the base plate.

If a magnet breaks off it can be reinstalled with a small amount of Two Part epoxy compound using the following steps:

1. Thoroughly clean the broken magnet and its base plate position after removing adjacent hammers.
2. Check the magnet's polarity by inserting between adjacent magnets. If it is repelled turn the magnet over and note the attitude in which it must be inserted.
3. Apply a small amount of two part epoxy to the mating surfaces, removing excess. Join magnet to base plate. Check for squeeze out of epoxy and wipe away excess. Shim the magnet with cardboard to maintain hammer clearance on either side and let dry overnight.
4. Replace the hammers and check for clearance between hammers and epoxied magnet. Complete reassembly and test.

CPL

Title 2310 DATA PRODUCT LINE PRINTER - BACK PANEL INFO.						Tech Tip Number LP01-TT-3		
All	Processor Applicability					Author D. Oldham	Rev 0	Cross Reference
X						Approval H. Long	Date 6/6/72	

Extreme care should be taken when tightening down the screws that hold the plastic panel on the card cage on Data Products printers. Tightening down on these screws too hard can crack the bussed runs in back of the wiring panel, and they are impossible to repair.

One of the most pronounced symptoms is a fluctuating +12V line to individual modules, the most susceptible being the AH10, hammer driver module, where the 2 ohm resistor and driver transistor are destroyed when the +12V is lost.

ECO LP01-~~9999~~ checks for a complete loss of the +22 or +12V line to protect the hammer driver modules, but will never detect +12V loss to and individual module.

COMPANY CONFIDENTIAL

digital	FIELD SERVICE TECHNICAL MANUAL				Option or Designator LP01
	12 Bit <input checked="" type="checkbox"/>	16 Bit <input checked="" type="checkbox"/>	18 Bit <input checked="" type="checkbox"/>	36 Bit <input checked="" type="checkbox"/>	

Title DATA PRODUCTS SEMI-CONDUCTOR CREF				Tech Tip Number LP01-TT-4	
All X	Processor Applicability			Author D. OLDHAM	Rev
				Approval H. LONG	Date 5/24/72
					Cross Reference

This is a list of replacement semiconductors and resistors for Data Products Line Printer.

DATA P's P/N	DEC P/N	DESCRIPTION	MFG. NAME'S & P/N'S
800018-001	15-09523	Transistor DPC202/202A	RCA # 2N3054
800019-001	29-16826	Transistor DPC201C	MOTOROLA # 2N4233
800020-001	19-05577	I.C., 7420	MOTOROLA
800021-001	19-05578	I.C., 7430	Sprague SN7420N
800022-001	19-05579	I.C., 7440	Sprague SN7430N
800023-001	19-05576	I.C., 7410	Sprague SN7440N
800024-001	19-05575	I.C., 7400	Sprague SN7410N
800026-001	19-05580	I.C., 7450	Sprague SN7400N
800030-470	13-00202	Resistor, 47 1/4w 5%	-----
800080-001	19-09004	I.C., 7402	Sprague SN7402N
800081-001	19-05585	I.C., 7476	Sprague SN7476N
800088-001	29-17394	Transistor, 2N3253	Motorola 2N3253
800088-001	29-17781	Transistor, 2N3253	Motorola 2N3253
800089-001	15-01742	Transistor, 2N2904	Motorola 2N2904
800093-001		Diode, 1N4154	I.T.T. 1N4154
800095-001	11-04861	Diode, 1N4002	I.T.T. 1N4002
800132-001	15-03121	Transistor, DPC205A	Motorola 2N2369
800133-001	15-01870	Transistor, 2N2894	Motorola 2N2894
	29-16780		
800186-001	29-16830	I.C., OP AMP LM711CN	Nat'l Semicond. LM711 CN
			Motorola IN5232
800187-001	29-17875	Diode, Z 5.6V IN5232	
	29-17909		
800188-001	29-16804	Diode, Z 9.1V IN757A	C.D.C. IN757A
800188-001	29-16831	Diode, Z 9.1V IN757A	C.D.C. IN757A
800188-001	29-17785	Diode, Z 9.1V IN757A	C.D.C. 0M757A
800190-001	29-16781	SCR, TRIAC 2N4213	Motorola 2N4213
800190-001	29-16781	SCR, TRIAC 2N1595	Fairchild 2N1595
800191-001	29-16782	Transistor 2N1597	Motorola 2N1597
800192-001	29-17509	SCR, 2N683	Motorola 2N683
800192-001	29-17934	SCR, 2N683	RCA 2N683
800195-001	29-16829	OPAMP, LM707 CN	Nat'l Semicond. LM 709CN
			Nat'l Semicond. LM 709CN
800195-001	29-17906	OPAMP, LM709CN	
			Dale
800210-100		Resistor, 1 1 w 1%	Dale
800210-295		Resistor, 2 1 w 1%	Dale

COMPANY CONFIDENTIAL

Title DATA PRODUCTS SEMI-CONDUCTOR CREF (Continued)						Tech Tip Number LP01-TT-4	
Processor Applicability				Author D. Oldham		Rev 0	
All X				Approval H. Long		Date 5/24/72	
Cross Reference							

<u>DATA P's PN</u>	<u>DEC P/N</u>	<u>DESCRIPTION</u>	<u>MFG. NAME'S & P/N's</u>
800214-001	29-17793	Diode, 1N 1192	Motorola 1N1192
800215-001	15-05819	Transistor, 2N3055	Motorola 2N3055
800232-001		I.C., Memory TMS3000LR	T.I., TMS3000LR
800349-001	29-17802	TRIAC, 2N5573	R.C.A. 2N5573
800349-001	29-17802	TRIAC, SC50B	G.E. SC50B
800376-001	29-15043	TRIAC, 2N5574	R.C.A. 2N5574
800370-001		I.C. Data Comp 7486	Sprague SN7486N
800386-001	29-17790	I.C., 74193	Sprague SN74193N
800387-001	29-17791	I.C., 7404	Sprague SN7404N
800387-001	19-09686	I.C., 7404	Sprague SN7404N
800393-001	29-17792	I.C., DM8220N	Nat'l Semicond. DM8220N
800491-001		I.C., 7486	Sprague SN7486N
800516-001		Bridge, Diode SCBA 2	Semtech Alpac SCBA 2
800592-001	29-17875	Diode, Z 5.6v 1N5232	Motorola 1N5232

Added list of replacement semiconductors for LP08 Data Products Line Printers.

<u>DP P/N</u>	<u>DEC No.</u>	<u>DESCRIPTION</u>
800189-001	29-17786	Diode No Equip.
800210-205	29-17936	Resistor 2.0 1W 1% Dale

COMPANY CONFIDENTIAL

CPL

digital	FIELD SERVICE TECHNICAL MANUAL				Option or Designator
	12 Bit <input type="checkbox"/>	16 Bit <input checked="" type="checkbox"/>	18 Bit <input checked="" type="checkbox"/>	36 Bit <input checked="" type="checkbox"/>	LP01

Title				MARK IV HAMMER DESIGN CHANGE				Tech Tip Number		LP01-TT-5	
All		Processor Applicability				Author		Derek Oldham		Rev 0	
X						Approval		H. Long		Date 07/27/72	
										Cross Reference	

Description: The Mark IV Hammer Module (Data Products Part Number 208-504-1; DEC Part Number 29-16783) is mounted to the hammer bank assembly by a hammer hold down screw which goes through the assembly and screws into a brass insert in the hammer module base.

Change Description: The hammer module base has been redesigned deleting the brass insert and adding its function as part of the plastic molded base. The hammer modules are interchangeable.

Effectivity: The change was incorporated in the 2000 series printers in mid January 1972.

Impact: The screws that mount the hammer modules to the hammer bank, are not interchangeable. The new hammer module takes a longer screw (P/N 231699-001). The screws used for the former hammer module is shorter (Data Products P.M. 211727-001; DEC Part Number 29-15025). If the new screw is used with the former hammer module, the screw will bottom out and the hammer module will not be held securely to the hammer bank. If the old screw is used with the new hammer module, the hammer module will not be reliably secured to the hammer bank.

Solution: A new screw will be supplies with each new spare hammer module. This practice became effective February 14, 1972. This screw must be used when installing a new spare hammer module.

Use screw (P/N 211727-001 - DEC P/N 29-15025) when replacing a new hammer module with a former hammer module spare.

In an emergency, the new screw may be used in the "brass insert" hammer module by adding 5 each #6 .015" thick flat washers or any combination of #6 washers which add up to .075". These washers are to be used in conjunction with the existing split lock washer and flat washer. The existing flat washer is #6 .015" thick.

COMPANY CONFIDENTIAL

Title		LP01 INFORMATION				Tech Tip		Number LP01-TT-6	
All X	Processor Applicability				Author	J. Lacey	Rev	0	Cross Reference
					Approval	W. Cummins	Date	07/31/72	

Due to the mechanical construction of the LP01, it is a difficult and time consuming procedure to adjust the pickups for character (CHPO), index (INPO), and line strobe (LNSTPO) signals. Furthermore, the maintenance manual does not include the voltage levels or the kind of signals one might expect to see on the output of the pickups.

Test Set-Up for adjusting these signals:

Character Pickup

1. Bring printer to "READY" condition.
2. Set oscilloscope as follows:
 - a. time/div = 2 ms
 - b. channel 1 volts/div = 0.1 volt (X10 probe)
3. Observe CHPO at A3A15 pin 28. It should be at least four (4) volts peak to peak with the positive peak being a minimum of 2.5 volts. If need be, adjust* and/or replace the pickup.

Index Pickup

1. Bring printer to "READY" condition.
2. Set oscilloscope as follows:
 - a. time/div = 10 ms
 - b. channel 1 volts/div = 0.1 volts (X10 probe)
3. Observe INPO at A3A15 pin 38. It should be at least 2 volts peak to peak; if it isn't, adjust* and/or replace the pickup.

Line Strobe Pickup

1. Remove paper from printer.
2. Remove all paper fault indications (tape down the switches).
3. Bring printer to "READY" condition.
4. Replace print inhibit switch in the inhibit position.
5. Enter continuous form feed (refer to Tech Tip 8I, Section 17, Paragraph E.)
6. Set oscilloscope as follows:
 - a. time/div = 50 ms
 - b. channel 1 volts/div = 10mv (X10 probe)
7. Observe LNSTPO at A3A15 pin 48. It should be at least 0.3 volts peak to peak. If need by, adjust* and/or replace the pickup.

NOTE: The above voltage levels are minimum acceptable and larger signals are desired.

*To adjust Pick-UP

1. Loosen the locknut on pick-up.

* CAUTION *

Do not allow code wheel to hit pick-up as damage can occur.

2. Thread pick-up in or out until desired signal is obtained.
3. Tighten locknut; ensure pick-up does not move.

COMPANY CONFIDENTIAL

digital	FIELD SERVICE TECHNICAL MANUAL				Option or Designator
	12 Bit <input checked="" type="checkbox"/>	16 Bit <input checked="" type="checkbox"/>	18 Bit <input checked="" type="checkbox"/>	36 Bit <input checked="" type="checkbox"/>	LP01

Title LP01/LP02 PRINT QUALITY				Tech Tip Number LP01-TT-7	
All	Processor Applicability			Author J. Lacey	Rev 0
<input checked="" type="checkbox"/>				Approval W. Cummins	Date 07/31/72
					Cross Reference

There are many factors which contribute to print quality on a drum-type line printer. In fact, the very method by which the character is printed on the paper causes slight blurring and, at the same time, puts great stress on the paper. However, good print quality can be obtained if adjustments are made properly and a good grade of paper is used.

The ensuing discussion assumes that the following items have been checked and are in accordance with specifications. These six (6) items directly effect the print quality and adjustments must be performed as described.

All references will be in the DATA PRODUCTS CORPORATION TECHNICAL MANUAL unless stated otherwise.

- 1) Power Supply Voltages (Paragraphs 5-21 through 5-25)
- 2) Hammer Drive Current (Paragraph 5-31)
- 3) Hammer Flight Time (Paragraph 5-33)
- 4) Paper Feed Velocity Command (Paragraph 5-35)
- 5) Paper Drive Belt Tension (Paragraph 5-39)
- 6) Phasing (Paragraph 5-53, 5-57 for LP02)

The following items and/or adjustments will be covered in this discussion:

- A) Reversing the printer ribbon.
 - B) Cleaning the ribbon and the paper tension bar.
 - C) Checking ribbon tension.
 - D) Type of paper.
 - E) Paper tension.
 - F) Paper feed.
 - G) Cleaning the character drum.
 - H) Copies control lever.
- A) Proper care of the printer ribbon is of vital importance for good print quality. It should be pointed out that the first hour or so of printing with a new ribbon will probably result in some ink splatter. Best results will be obtained during the third to tenth hours of print time for most ribbons; however, by reversing the top and bottom ribbon spools after 6-8 hours, up to 15 hours of good print quality may be realized. The additional time gained is due to the fact that in normal use, printing is left justified, thereby placing a greater stress on the left side of the ribbon. Consequently the ribbon wears more on the left side causing skewing and its associated problems. By reversing the ribbon the strain is placed on the virtually unused portion, thus balancing the strain and allowing the heavily used side more time to relax and absorb ink from other parts of the ribbon.

COMPANY CONFIDENTIAL

Title						IMPROVING PRINT QUALITY ON THE LP01 (DATA PRODUCTS 2310) (Continued)		Tech Tip Number		LP01-TT- 7	
All		Processor Applicability				Author		Jim Lacey		Rev 0	
X						Approval		W. Cummins		Date	
Cross Reference											

- B) Ribbon and paper dust will accumulate on the paper tension bar (figure 1-8) and also become trapped in the ribbon as it winds on the spool. This will cause a smearing effect on the first copy of the printed paper when allowed to accumulate in sufficient quantities. Regular cleaning of the ribbon and the paper tension bar with a brush or other suitable tool should eliminate this problem.
- C) The ribbon tension should be checked to insure that the drag current is being applied to the ribbon take-up motors. This may be checked in the following manner:
- 1) With power on, open the drum gate and swing out the drum assembly.
 - 2) Check the drag current for the upper take-up by holding the lower ribbon spool and rolling the upper ribbon spool so that the ribbon goes slack. Now by releasing the upper spool, it should automatically rewind and pull the ribbon taut.
 - 3) Perform this same type of procedure for the lower ribbon take-up.
- D) The type of paper used will have an extremely important effect on print quality, particularly when using multi-part paper. An evaluation was conducted to determine the best six-part paper with carbons for use. The results are as follows:
- First Choice: Moore Business Forms, Inc.
Paper Weight: 11 pound multirite
Carbon Weight: 6 pound tab back
Performance: Good
Print Quality, Copy #6: Dark, Distinct
- Second Choice: Standard Register Company
Paper Weight: 10 pound Stancote (copies 1 through 5)
15 pound Stancote (copy 6)
Carbon Weight: #512 (Carbons 1 through 4)
#510 (Carbon 5)
Performance: Good
Print Quality, Copy #6: Medium to light, Distinct
- Third Choice: Royal Business Forms, Inc.
Paper Weight: 11 pound, Form 811-3
Carbon Weight: Unlabeled
Performance: Good
Print Quality, Copy #6: Dark, somewhat blurred

COMPANY CONFIDENTIAL

digital	FIELD SERVICE TECHNICAL MANUAL				<i>CPL</i> Option or Designator
	12 Bit <input checked="" type="checkbox"/>	16 Bit <input checked="" type="checkbox"/>	18 Bit <input checked="" type="checkbox"/>	36 Bit <input checked="" type="checkbox"/>	LP01

Title LP01/LP02 Print Quality (Continued)				Tech Tip Number LP01-TT-7	
All Processor Applicability		Author J. Lacey	Rev 0	Cross Reference	
<input checked="" type="checkbox"/>		Approval W. Cummins	Date		

- E) Paper tension is also quite important with respect to print quality on multi-part paper. A good rule to follow is to tension the paper as tightly as possible without introducing paper feed problems. Two methods may be employed to determine if paper feed problems exist, and may be used together as a comprehensive test. First, run test #6 of the LP08 diagnostic (Maindec-8I-D2AA). If this runs satisfactorily, you can be relatively certain that no problems exist in this area. Second, cause paper to skew at the maximum rate. This can be done when the printer is not ready by initiating a manual form feed and then pressing the form feed switch again and holding it prior to the completion of the form feed. This will cause a continuous slewing of paper at the maximum rate.
- F) The paper feed should also be checked to insure that when the paper is not in motion a reverse current is applied to the paper drive motor to hold the paper stationary when printing occurs. This may be checked in the following manner:
- 1) With power off, grasp the paper drive belt and pull it so that the paper tractors move in an upward direction. This should be the only direction that the tractors can be moved. You should be able to accomplish this with very little effort.
 - 2) With power on, move the paper tractors in the same manner as above. It should now be quite difficult to move the tractors due to the reverse current being applied to the motor.
- The symptoms which accompany a loss of reverse current are uneven spacing between lines and a double image on the top copy of print.
- G) Regular cleaning of the character drum is necessary for good reproduction on multi-part paper. The number of copies obtainable on a printer are primarily determined by the force with the hammer strikes the paper and the height of the characters on the drum. Hammer force cannot be changed without danger of damaging the hammers or hammer driver cards. And it is obvious that the height of the characters cannot be increased but we can take advantage of the full height of the characters by cleaning the print drum and removing any accumulated ink and debris regularly.

COMPANY CONFIDENTIAL

Title LP01/LP02 PRINT QUALITY (Continued)						Tech Tip Number LP01-TT-7		
All X	Processor Applicability					Author J. Lacey	Rev 0	Cross Reference
						Approval W. Cummins	Date 07/31/72	

- H) The setting of the copies control can also effect print quality. There is very little information concerning this adjustment, because all it does is allow you to change from single copy to multiple copy paper. This is accomplished by moving the hammer bank exactly the thickness of the paper, thus maintaining the same hammer flight time. It is possible, depending on the thickness of paper used, when changing from single copy to multiple copy paper that the copies control lever will need to be set at a position other than the one that corresponds with the number of copies being printed. When the copies control is out of adjustment it can cause one of two problems. First, if the hammer bank is too close to the paper, the hammer flight time is shortened and the top of the characters are lost because the hammer strikes the character drum too early. In extreme cases, paper jamming can result. Secondly, if the hammer bank is not close enough, the flight time is increased and the bottom of the characters are lost. The increased flight time also means that the hammer strikes with less force and degrades the print quality on the back copies. In extreme cases, hammers may be damaged.

This information was made possible largely through the efforts of John Benton.

Title LP01/LP02 HAMMER/HAMMER DRIVER FAILURE						Tech Tip Number LP01-TT- 8		
All X	Processor Applicability					Author J. Lacey	Rev 0	Cross Reference
						Approval W. Cummins	Date	

Upon the failure of a hammer driver module it is possible that a hammer may be destroyed, which in turn could cause damage to the replacement hammer driver module.

Before replacing a failed hammer driver module it is advisable to insure that none of the hammers were damaged. This can be accomplished by removing all of the hammer driver modules and taking resistance readings across each of the hammers. If the resistance of any hammer is not between 15 and 20 OHMS (nominal 18 OHMS) it should be considered bad and replaced.

COMPANY CONFIDENTIAL

CPL

digital	FIELD SERVICE TECHNICAL MANUAL				Option or Designator LP01
	12 Bit <input checked="" type="checkbox"/>	16 Bit <input checked="" type="checkbox"/>	18 Bit <input checked="" type="checkbox"/>	36 Bit <input checked="" type="checkbox"/>	

Title LP01/LP02 HAMMER FLIGHT TIME ADJUSTMENT				Tech Tip Number LP01-TT-9	
All X	Processor Applicability		Author R. Rasmussen	Rev 0	Cross Reference
			Approval W. Cummins	Date 07/31/72	

Calibration of hammer flight time in the LP01 Technical Manual starts (for LP02) at paragraph 5-32. After adjusting hammer #1 per paragraph 5-33c3, follow the following procedure.

NOTE: References to LP02 that are different than LP01 are shown in parenthesis.

- 1) Set oscilloscope as follows:

<u>Switch or Control</u>	<u>Setting</u>
Mode	A & B alt
Coupling Mode	AC
Triggering slope	Neg.
Triggering source	Int.
Triggering	Channel 1 only
Channel A & B volt	.5V per CM (X10 probes)
Input channel mode	AC
Time Base	2 ms per CM
X10 Multiplier	ON

- 2) Channel A should be on A3-22B (Hammer #1) (A3-4B)
Channel B should be on A3-22H (Hammer #2) (A3-4H)
- 3) Adjust scope's vertical and horizontal position for following signals:

FIGURE -1A

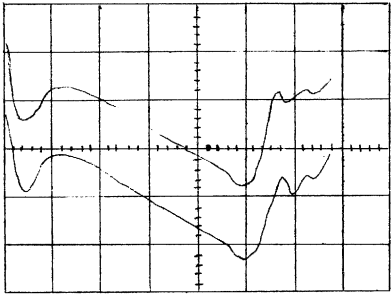

COMPANY CONFIDENTIAL

Title LP01/LP02 HAMMER FLIGHT TIME ADJUSTMENT (Continued)				Tech Tip Number LP01-TT-9	
Processor Applicability				Author R. Rasmussen Rev 0	
All X				Approval W. Cummins Date	
				Cross Reference	

- 4) The wave form seen is the negative portion of a 65V negative pulse.
- 5) Now reset scope to ADD channel B INVERTED. The waveform now seen should resemble the waveform shown below. The dotted area drawn indicates the error and should be adjusted out by turning appropriate allen screw adjustment.

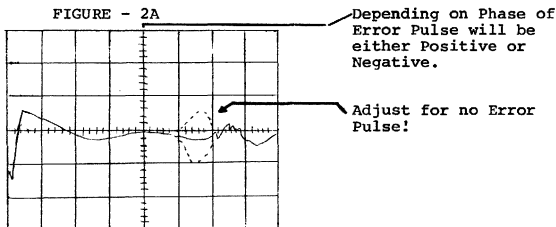

- 6) Refer to table 5-5 and connect channel B probe to test point of hammer to be adjusted with hammer #1 as reference.
- 7) Adjust hammer 3 through 20 (24) per figure 2A.
- 8) Change to zone 1 and 2 on interface test board. Multiple waveforms will be observed as zones are added.
- 9) Change scope setting from ADD to Channel A. Now adjust hammer #21 (25) so it falls simultaneously with waveform produced by Hammer #1. The hammer #1 and hammer #21 (25) waveform will look similar to Figure 3A.

FIGURE - 3A

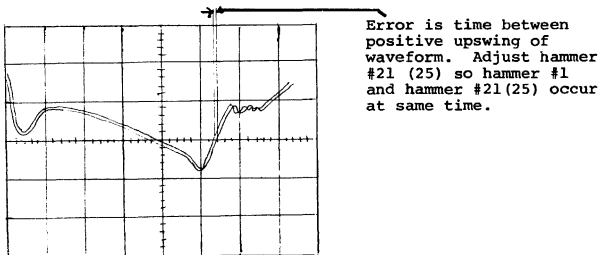

COMPANY CONFIDENTIAL

COMPANY CONFIDENTIAL

digital	FIELD SERVICE TECHNICAL MANUAL				Option or Designator LP01
	12 Bit <input checked="" type="checkbox"/>	16 Bit <input checked="" type="checkbox"/>	18 Bit <input checked="" type="checkbox"/>	36 Bit <input checked="" type="checkbox"/>	

Title LP01/LP02 HAMMER FLIGHT TIME ADJUSTMENT (Continued)				Tech Tip Number LP01-TT-9	
All Processor Applicability		Author R. Rasmussen		Rev 0	
X		Approval W. Cummins		Date 07/31/72	
Cross Reference					

- 10) After hammer #21 (25) has been adjusted, change scopes setting back to ADD channel B inverted. Now adjust hammer 22 (26) per Figure - 2A. Adjusting out error pulse. Continue by adjusting hammers 23 (27) through 40, then change interface card for zones 1, 2 and 3.
- 11) Now adjust hammer #41 (49) to coincide with hammer #1 and 21(25).
- 12) Adjust hammer #42(50) through 60(72) as hammers 2-20(24) and 22 - 40(26-48) were adjusted.
- 13) Change zones to 1, 2, 3, and 4.
- 14) Adjust hammer 61(73) to coincide with hammers 1, 21, 41, (1, 25, 49).
- 15) Now adjust hammers #62(74) through 80(96) as hammer 2-20(2-24), 22-40(26-48), and 42-60(50-72) were adjusted.
- 16) For LP02's continue adjusting hammers in zones 5 & 6 in the same manner. (That is; hammers 97 through 120, and 121 through 132). This should provide a faster (3-4 times) and much more accurate setup for the hammers.

Title. ELIMINATION OF AUTOMATIC PERFORATION STEPOVER				Tech Tip Number LP01-TT-10	
All Processor Applicability		Author H. Fitek		Rev A	
X		Approval W. Cummins		Date 07/31/72	
Cross Reference					

How to prevent automatic perforation stepover.

2310 printer (80 Col.)

Vendor Serial Numbers
 041, 153, 159, 165, 080, 093, 124, 133, 134, 144, 156, 157,
 158, 159, 160, 167, 168, 175, 178, 179, 180, 182, 186, 187,
 188, 189, 190, 191, 192, 193, 194, 197, 198, 199, 200, 201,
 203 and up through #555. Serial #556 & up do not have auto
 perforation stepover.

1. Remove wire between A9-32 and A4-25
2. Remove wire between A9-10 and A4-20
3. Add wire between A4-20 and A4-28.

For all other serial numbers, remove wire between A9-32 and A4-25.

COMPANY CONFIDENTIAL

Title DATA PRODUCTS C.I.B. (AZ=19 Substitution)						Tech Tip Number LP01-TT-11		
All	Processor Applicability					Author R. Shelley	Rev 0	Cross Reference
X						Approval W. Cummins	Date 07/31/72	

A customer information bulletin from Data Products is as follows: L1

Change Description:

The AZ-19, Hammer Interlock, circuit board assembly (P/N 212500) is being replaced by an AZ-167 (P/N 215565). The reason for this change is to improve voltage loss detection. The AZ-167 will perform the function of the AZ-19 and voltage monitor circuit (P/N 214278-2).

The paper guide/ribbon guide assembly (reference 2410 Manual Fig. 3-4) is being eliminated. This change will simplify mechanical alignment and make the units less susceptible to operator abuse. The change also reduces "smudging" by minimizing unwanted contact between paper and ribbon.

Effectivity:

The AZ-167 will be incorporated at S/N 2525 scheduled for October delivery. The AZ-167 can be used interchangeably with the AZ-19 in all units. The AZ-19 cannot be used in units above S/N 2525. This change will also be implemented in the Model 2310 in the near future.

The paper guide/ribbon guide will not be used after S/N 2492.

Title INSTALLATION OF AUTOMATIC PERFORATION STEPOVER						Tech Tip Number LP01-TT-12		
All	Processor Applicability					Author W. Cummins	Rev 0	Cross Reference
X						Approval W. Cummins	Date 07/31/72	

All Data Product Line Printers (2310-80 column) delivered to DEC that are above Data Product serial number 556 DO NOT HAVE automatic perforation stepover installed. If you have any customers who desire this feature, the following change must be made:

Add a wire from 9-27 to 4-25 on the logic cage.

Title LP01 96-Character Drum						Tech Tip Number LP01-TT-13		
All	Processor Applicability					Author J. Lacey	Rev 0	Cross Reference
X						Approval W. Cummins	Date	

The LP01 normally has a 64-character print drum, but as an option a 96-character print drum is available. Unfortunately there is very little information in the Data Products Corporation Technical Manual regarding this option, which has caused some concern. The following provides additional information.

1. Nonprintable Code Detector (Figure 6-7)
Pin 31 on the input is grounded thus making 140 through 177 legal.

digital	FIELD SERVICE TECHNICAL MANUAL				Option or Designator
	12 Bit <input checked="" type="checkbox"/>	16 Bit <input checked="" type="checkbox"/>	18 Bit <input checked="" type="checkbox"/>	36 Bit <input checked="" type="checkbox"/>	LP01

Title	LP01 96 CHARACTER DRUM (Continued)			Tech Tip Number	LP01-TT-13
All	Processor Applicability	Author	J. Lacey	Rev	0
X		Approval	W. Cummins	Date	07/31/72
				Cross Reference	

- 2) Character Code Wheel (Figure 5-23)
In paragraph 5-55 step 3, substitute "N and O" in the place of "a".

Title	PROBLEMS ATTRIBUTED TO THE STATIC ELIMINATOR			Tech Tip Number	LP01-TT-14
All	Processor Applicability	Author	D. Oldham	Rev	0
X		Approval	H. Long	Date	8/15/71
				Cross Reference	

Most static eliminator problems are caused by dirt, and can be corrected using the following procedure.

NOTE: Item numbers in brackets refer to drawing below.

- 1) Clean the bar or wand itself by brushing the dust off the wires and associated holes in the bar. Wipe the entire bar with an Isopropyl Alcohol dampened cloth removing all dull residue from the plastic.
2. Remove the cable end from the transformer (item 4) and polish with fine sandpaper.
3. Clean the spring loaded pin in the center of the transformer connector (item #3).
4. Carefully disassemble the cable connection at the wand, removing
 - a) the cable
 - b) the threaded rod adapter with the spring loaded pin contacts and be careful the plastic is soft and deforms easily.

Now clean and polish the contacting surfaces (items 1 and 2).

5. Reassemble and test printer operation. If the same symptoms exist after performing the above procedure, check the eliminator bar. Using a medium length, flat bladed, plastic handled screwdriver.
 - a) With power on ground the shank of the screwdriver to the paper guide cage.

COMPANY CONFIDENTIAL

Title					Tech Tip Number		LP01-TT-14
PROBLEMS ATTRIBUTED TO THE STATIC ELIMINATOR (Continued)					Author		D. Oldham
Processor Applicability					Rev		0
All					Approval		H. Long
X					Date		8/15/72
							Cross Reference

- b) Advance a corner of the screwdriver blade towards the spring point in each orifice of the bar. There should be an ARC of between 1/8" and 1/4". No less than 1/8" and no more than 5/16".

Repeat this for each hole and point in the bar.

If any hole fails this test replace the bar.

If no ARC is present anywhere along the bar, do the following.

1. Check primary power to the eliminator transformer. If OK, go the the next step.
2. Replace static eliminator assembly (the assembly includes the bar).

Part Numbers for the above are:

115 Volts 50/60 Hz

LP01 Bar.....29-17943
 LP01 Transformer....29-17944
 *LP01 Assembly.....29-17520
 LP02 Bar.....29-19364
 LP02 Transformer....29-17944
 *LP02 Assembly.....29-19407

Other Vols 50/60 Hz

29-17943
 Note 1
 Note 1
 29-19364
 Note 1
 Note 1

*Assembly contains bar, cable, transformer and hardware.

Note 1: Specify voltage at time of order (i.e. 230V).

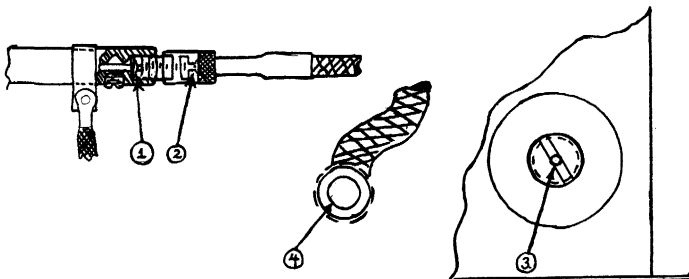

COMPANY CONFIDENTIAL

digital	FIELD SERVICE TECHNICAL MANUAL				Option or Designator LP01
	12 Bit <input checked="" type="checkbox"/>	16 Bit <input checked="" type="checkbox"/>	18 Bit <input checked="" type="checkbox"/>	36 Bit <input checked="" type="checkbox"/>	

Title PROBLEMS ATTRIBUTED TO THE STATIC ELIMINATOR (Continued)				Tech Tip Number LP01-TT-14	
All		Processor Applicability	Author D. Oldham	Rev 0	Cross Reference
X			Approval H. Long	Date 8/15/72	

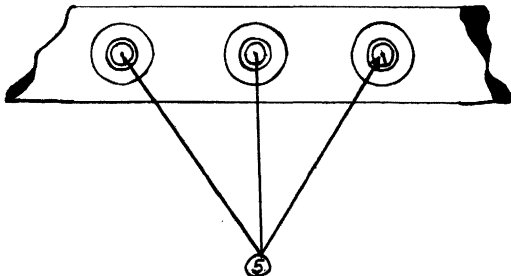

Title Data Products Line Printer Ribbon				Tech Tip Number LP01-TT-15	
All		Processor Applicability	Author R.K. Stannard	Rev 0	Cross Reference
X			Approval W. Cummins	Date 10.13.72	

The end of a Line Printer ribbons life is often caused by stretching and skew problems, which eventually cause it to tear and maybe get jammed in the drum.

As most printers call for routine cleaning of the drum area on a weekly (maybe monthly) basis, it is a good idea to reverse the ribbon rolls (top to bottom) at this time to even out any stretching that has taken place and significantly improve ribbon life.

Title LP01/LP02 ZONE CONTROL PROBLEM						Tech Tip Number LP01-TT-16	
Processor Applicability						Author J. Byeyer/D, Oldham Rev 8	
All						Cross Reference	
X						Approval W. Cummins Date 02/16/73	

PROBLEM DESCRIPTION:

Zone control logic resets to zone one somewhere in the middle of printed a line.

The problem may be very intermittent and may only occur when printing sliding alpha-pattern on full lines. A bad print line will be completely blank in one or more right hand zones, and the characters from those zones will be printed over good characters in the left hand zones on the same line. Changing logic cards will not affect this problem at all.

PROBLEM CAUSE:

A cracked hammer return spring generating noise on the +65 volt power supply.

TROUBLESHOOTING:

- 1) Visually examine all of the hammer modules. If the cracked spring cannot be seen, do the following:
- 2) The bad hammer module will be in the last zone printed before the zone control reset failure. Example: If the bad hammer is in zone 2, zones 1 and 2 will be over-printed, and zones 3 and 4 on an LP01 will be blank. On an LP02, zones 3 and 4 may contain characters from zones 5 and 6 (5 and 6 will be blank).
- 3) Remove power from the printed and locate the +65 volt leads to the odd hammers. (Note! The +65 volt supply takes about three minutes to bleed off! Meter the lead on the hammer bank for no voltage.)
- 4) Pull the +65 volt lead to the odd hammers of the zone identified in step 2 and carefully insulate the lead from frame ground.
- 5) Apply power to the printer and see if the sliding alpha-print pattern still fails. (Note: The odd hammers will not fire in the zone where you pulled the +65 volt lead.)
- 6) If the zone control still fails, the bad hammer is one of the even hammers of the zone. If the print line is normal, except for not printing the odd hammers of one zone, the bad hammer is one of the odd hammers of the zone.
- 7) Remove power from the printer and after checking the +65 volt lead for no voltage, reinsert the lead that you pulled in Step 4.

COMPANY CONFIDENTIAL

digital	FIELD SERVICE TECHNICAL MANUAL				Option or Designator
	12 Bit <input checked="" type="checkbox"/>	16 Bit <input type="checkbox"/>	18 Bit <input checked="" type="checkbox"/>	36 Bit <input checked="" type="checkbox"/>	LP01

Title	LP01/LP02 ZONE CONTROL PROBLEM (Continued)	Tech Tip Number	LP01/TT-16
All	Processor Applicability	Author J. Breyer/D.Oldham Rev 0	Cross Reference
X		Approval W. Cummins Date 02/16/73	

- 8) Pull a lead for the lowest numbered hammer in the bad zone, from either the odd or the even hammer bank as indicated by Step 6. Carefully insulate the lead from frame ground.
- 9) Apply power to the printer and see if the sliding alpha-pattern still fails. (Note: The disconnected hammer will not fire in any case.)
- 10) If the print line is normal, except for one blank, column, you have found the bad hammer module. Replace it. (Data Products Part Number 208504-1; DEC Part Number 29-16783.)
- 11) If the zone control still fails, remove power from the printer and repeat steps 8 through 10 for each odd or even hammer in the bad hammer is located and replaced.

WARNING!

The +65 volts for the hammers also goes to the A3 card cage. Careless troubleshooting can lead to disaster!

Title	DRUM GATE LIGHT BULB FAILURE	Tech Tip Number	LP01-TT-17
All	Processor Applicability	Author Al Shiner Rev 0	Cross Reference
X		Approval Harold Long Date 02/26/73	

When drum gate light bulb burns out the line printer will not go ready. It opens the +12V that starts the 10 second delay. If desired, a 1-2K resistor across the light socket will allow the logic level to get through when the bulb is open and will not affect normal operation with a good bulb.

Title UPPER PAPER-OUT SWITCH SENSITIVITY						Tech Tip Number LP01-TT-18		
All	Processor Applicability					Author R. Shelley	Rev 0	Cross Reference
	12	16	18			Approval F. Purcell	Date 9/11/73	

The upper paper out switch on the Data Products 2310 and 2410 printers may appear to be sensitive, causing the printer to go NOT READY intermittently.

Data Products makes the following recommendations:

1. Paper weight (single part) must be 15 lbs. minimum.
2. Make sure the mercury capsule switch is mounted such that its contacts are in a horizontal plane.

Title DRUM ASSEMBLY						Tech Tip Number LP01-TT-19		
All	Processor Applicability					Author R. Boehm	Rev 0	Cross Reference
	x					Approval F. Miller	Date 12/1/73	

Two different 96 character drum assemblies exist for the LP01 line printer. The drum can be quickly checked to see which is which.

The old model drum assembly has a heart character on it and this drum is our part number 29-17942, Data Products P/N 215-361-001. The new model drum does not have a heart on it and cross references to Data Products P/N 218-840.

When ordering a new model drum order using the DEC P/N 29-21014.

Title Intermittant Data Loss						Tech Tip Number LP01-TT-20		
All	Processor Applicability					Author Jerry Sarasin	Rev 0	Cross Reference
	x					Approval Chris Ball	Date Feb 74	

Check all AM21 Modules on LP01 and LP02. If the shift register IC is a Texas Instrument Part #TNS3122 Module it should be sent back to Data Products for Warranty Replacement.

The Defective TI Shift Register may have been used on the following:
 LP01 (2310) Serial #2569-2730 (DP S/N)
 LP02 (2410) Serial #3720-3800

Title Data Line Pull-Up Resistors						Tech Tip Number LP01-TT-21		
All	Processor Applicability					Author Tony Mongillo	Rev 0	Cross Reference
	x					Approval Jerry Sarasin	Date 8/13/74	
Title Hammer Current Monitor Check						Tech Tip Number LP01-TT-22		
All	Processor Applicability					Author Tony Mongillo	Rev 0	Cross Reference
	x					Approval Jerry Sarasin	Date 8/13/74	

CPL

digital	FIELD SERVICE TECHNICAL MANUAL				Option or Designator
	12 Bit <input checked="" type="checkbox"/>	16 Bit <input checked="" type="checkbox"/>	18 Bit <input checked="" type="checkbox"/>	36 Bit <input checked="" type="checkbox"/>	LP02

Title LP02 PAPER RECEPTICLE				Tech Tip Number LP02-TT-1	
All	Processor Applicability		Author D. Oldham	Rev 0	Cross Reference
X			Approval H. Long	Date 6/6/72	

All LP02's shipped from DEC after April 30, 1972, will have printed form receptacles.

For earlier printers; the receptacles are available from DEC. The price to the customer is \$90.00 plus installation charges at current rates.

The part number is 12-11025 and can be ordered through the Field Service Stockroom in Maynard.

CPL

Title LP01/LP02 Hammer Bank Magnets				Tech Tip Number LP02-TT-2	
All	Processor Applicability		Author D. Oldham	Rev 0	Cross Reference
X			Approval H. Long	Date 6/6/72	

CPL

Title DATA PRODUCTS SEMI CONDUCTOR CREF				Tech Tip Number LP02-TT-3	
All	Processor Applicability		Author D. Oldham	Rev 0	Cross Reference
X			Approval H. Long	Date 6/6/72	

CPL

Title MARK IV HAMMER DESIGN CHANGE				Tech Tip Number LP02-TT-4	
All	Processor Applicability		Author D. Oldham	Rev 0	Cross Reference
X			Approval H. Long	Date 6/6/72	

COMPANY CONFIDENTIAL

Title LP02 CHANGES										Tech Tip Number LP02-TT-5	
All	Processor Applicability					Author R. Shelley		Rev 0		Cross Reference	
X						Approval W. Cummins		Date 06/28/72			

- 1) The AZ-19, Hammer Interlock, circuit board assembly (P/N 212500) is being replaced by an AZ-167 (P/N 215565). The reason for this change is to improve voltage loss detection. The AZ-167 will perform the function of the AZ-19 and voltage monitor circuit (P/N 214278-2).

The AZ-167 will be incorporated at S/N 2525 scheduled for October '71 delivery. The AZ-167 can be used interchangeably with the AZ-19 in all units. The AZ-19 cannot be used in units above S/N 2525. This change will also be implemented in the Model 2310 in the near future.

- 2) The paper guide/ribbon guide assembly (reference 2410 Manual Fig. 3-4) is being eliminated. This change will simplify mechanical alignment and make the units less susceptible to operator abuse. The change also reduces "smudging" by minimizing unwanted contact between paper and ribbon.

The paper guide/ribbon guide will not be used after S/N 2492.

Title REMOVAL OF STEPOVER FUNCTION OF 2410 MODEL										Tech Tip Number LP02-TT-6	
All	Processor Applicability					Author Henry Fitek		Rev 0		Cross Reference	
						Approval W. Cummins		Date 07/31/72			

2410 MODEL

Remove wire between A26-22 and A15-57
Add a wire between A15-57 and A15-54

Title LP01 INFORMATION										Tech Tip Number LP02-TT-7	
All	Processor Applicability					Author J. Lacey		Rev 0		Cross Reference	
X						Approval W. Cummins		Date 07/31/72			

Title NOISE PROBLEM ON DATA PRODUCTS LINE PRINTER										Tech Tip Number LP02-TT-8	
All	Processor Applicability					Author B. Freeman		Rev 0		Cross Reference	
X						Approval B. Cummins		Date 07/31/72			

COMPANY CONFIDENTIAL

digital	FIELD SERVICE TECHNICAL MANUAL				Option or Designator
	12 Bit <input checked="" type="checkbox"/>	16 Bit <input checked="" type="checkbox"/>	18 Bit <input checked="" type="checkbox"/>	36 Bit <input checked="" type="checkbox"/>	LP02

Title LP01/LP02 PRINT QUALITY					Tech Tip Number LP02-TT-9	
All Processor Applicability					Author J. Lacey	Rev 0
x					Approval W. Cummins	Date 08/08/72
					Cross Reference LP01-TT-7	

Title LP01/LP02 HAMMER/HAMMER DRIVER FAILURE					Tech Tip Number LP02-TT-10	
All Processor Applicability					Author J. Lacey	Rev 0
x					Approval W. Cummins	Date 07/31/72
					Cross Reference LP01-TT-8	

Title LP01/LP02 HAMMER FLIGHT TIME ADJUSTMENT					Tech Tip Number LP02-TT-11	
All Processor Applicability					Author R. Rasmussen	Rev 0
x					Approval W. Cummins	Date 07/31/72
					Cross Reference LP01-TT-9	

Title FORM-FEED OVER-SHOOT					Tech Tip Number LP02-TT-12	
All Processor Applicability					Author Robert Shelley	Rev 0
8 9 11 12 15					Approval Frank Purcell	Date 02/08/73
					Cross Reference	

When the LP02 is sent a line-feed immediately followed by a form-feed, the paper will advance one line too far into the new page.

This is caused by a design error in the Data Products 2410 printer. This can be corrected by a change to the AG23 module slot 23 of card cage A3. See Fig. 6-9 gate Z6C of Data Prod. 2410 manual.

Cut the etch from Z6 pin 11 (signal FFFF*), then tie Z6 pin 11 to Z6 pin 14. (Signal LSF2)

/mt

COMPANY CONFIDENTIAL

Title <u>RIBBON MOTOR STALLS</u>						Tech Tip Number <u>LP02-13</u>	
All Processor Applicability			Author <u>Bill Kochman</u>		Rev <u>0</u>		Cross Reference
8			Approval <u>Frank Purcell</u>		Date <u>9/14/73</u>		

On 50 cycle systems the ribbon motor may stop intermittently towards the end of the ribbon. The Data Products ECO to fix this is to change R309 from 5.6K to 6.8K 1% 3W on the AZ15 module.

This applies to the DP2410 printers.

Title <u>INTERMITTANT DATA LOSS</u>						Tech Tip Number <u>LP02-TT-14</u>	
All Processor Applicability			Author <u>Jerry Sarasin</u>		Rev <u>0</u>		Cross Reference
X			Approval <u>Chris Ball</u>		Date <u>2/74</u>		

This Tech Tip issued for cross reference purposes only.

Title <u>Data Line Pull-Up Resistors</u>						Tech Tip Number <u>LP02-TT-15</u>	
All Processor Applicability			Author <u>Tony Mongillo</u>		Rev <u>0</u>		Cross Reference
X			Approval		Date		

If an LP01 or LP02 is moved from an 8 system to an 11 system or vice-versa, it should be noted that different pull-up resistors are used with the 8 and 11 controllers. These resistors are located in the printer on the interface board (LP01-A3P25 card; LP02-A3P14 card). The interface board is located at the end of the I/O cable. The 8 should have 100 ohm pull-up resistors on the 7 data lines and data strobe line on the interface card. The 11 should have no pull-up resistors on the interface card.

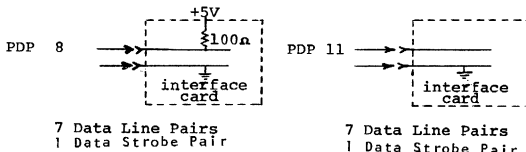

Title <u>Hammer Current Monitor Check</u>						Tech Tip Number <u>LP02-TT16</u>	
All Processor Applicability			Author <u>Tony Mongillo</u>		Rev <u>0</u>		Cross Reference
X			Approval <u>Jerry Sarasin</u>		Date <u>8/27/74</u>		

The Hammer Current Monitor that was installed in all LP01's and LP02's by ECO #LP01-A0016 and LP02-A0008 respectively or by Data Products at Manufacture should be checked at installation and at every scheduled P.M. to ensure that it is functioning properly.

The procedure for checking this monitor is given in the D.P. Manual and in the instructions for installing the ECO kit. The procedure requires a 150 ohm 10 watt resistor and a 500 ohm, 10 watt resistor. If they are not readily available, they are stocked in Maynard.

digital	FIELD SERVICE TECHNICAL MANUAL				CPI Option or Designator
	12 Bit <input checked="" type="checkbox"/>	16 Bit <input checked="" type="checkbox"/>	18 Bit <input checked="" type="checkbox"/>	36 Bit <input checked="" type="checkbox"/>	LP02

Title DRUM MOTOR BELTS AND PULLEYS (LP#1 vs LP#2)					Tech Tip Number LP02-TT-17	
All Processor Applicability			Author Ray Alvarez		Rev 0	
X			Approval Dale Staupe		Date 9/13/74	
					Cross Reference	

This Tech Tip is to help Field Personnel order the right pulley and belt for a 64 character or 96 character LP01 and LP02 line printer. Through investigation we have found that our stock rooms have not been carrying the right pulleys for the 96 character LP02 line printer and have been shipping the standard 64 character pulley instead. We have outlined two tables for this use, table 1 is for the LP01 and table 2 is for the LP02, also included is a drawing designating the corresponding items.

- Item (A) is the drum motor pulley
- Item (B) is the drum pulley
- Item (C) is the drum motor
- Item (D) is the drum motor belt

The stockrooms have been notified and this should eliminate any future problems.

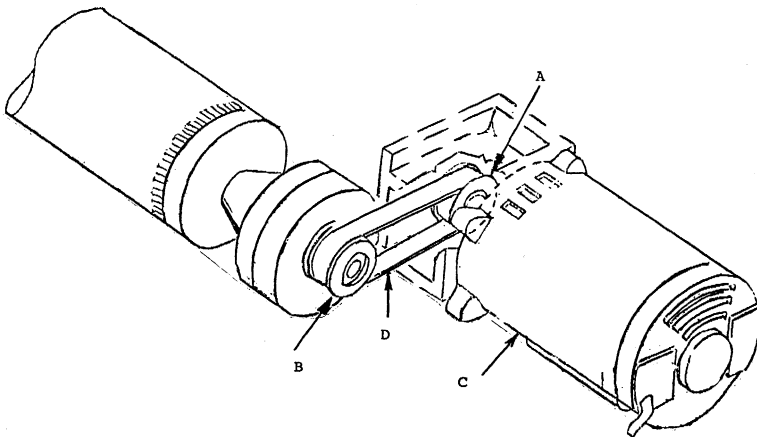

Title DRUM MOTOR BELTS AND PULLEYS (LP#1 vs LP#2)					Tech Tip LP02-TT-17 Number to LPD8	
Processor Applicability			Author Ray Alvarez	Rev 0	Cross Reference	
All X			Approval Dale Staupel	Date 9/13/74		

TABLE 1 (LP01)

Drum Type	Frequency	DPC Motor P/N (DEC Part No.)	DPC Pulley P/N (DEC Part No.)	Pulley Des.	No. of Teeth
64 Char	60 Hz	800 180-001 (29-15019)	212712-4 (29-17489)	A	22
			212712-2 (29-19534)	B	22
96 Char	60 Hz	800 180-001 (29-15019)	215603-1 (29-19531)	A	16
			215603-4 (29-19528)	B	24
64 Char	Drum Motor Belt P/N 800 299-001 (29-15022)				
96 Char	Drum Motor Belt P/N 800 299-002 (29-19312)				

TABLE 2 (LP02)

Drum Type	Frequency	DPC Motor P/N (DEC P/N)	DPC Pulley P/N (DEC P/N)	Pulley Des.	No. of Teeth
64 Char	60 Hz	800 514-001 (29-16800)	216860-1 (29-18230)	A	22
			216859-2 (29-18211)	B	22
96 Char	60 Hz	800514-001 (29-16800)	216766-1 (29-21633)	A	20
			216767-1 29-20015	B	30
64 Char	Drum Motor Belt P/N 800 299-005 (29-18208) "D"				
96 Char	Drum Motor Belt P/N 800 299-006 (29-19130) "D"				

Title LPD8/LINOTRON 505TC ERROR ISOLATION					Tech Tip Number LPD8-TT-1	
Processor Applicability			Author Rick Huse	Rev 0	Cross Reference	
All 8's			Approval George Chaisson	Date 4-4-74		

This Tech Tip is issued for Cross Reference Purposes.

digital	FIELD SERVICE TECHNICAL MANUAL				Option or Designator
	12 Bit <input checked="" type="checkbox"/>	16 Bit <input type="checkbox"/>	18 Bit <input type="checkbox"/>	36 Bit <input type="checkbox"/>	LP08

Title LP08 INTERFACE, INCOMPLETE +3V RUN				Tech Tip Number LP08-TT-1	
All	Processor Applicability			Author R. Nunley	Rev 0
X				Approval W. Cummins	Date
					Cross Reference

With some LP08 interfaces, it has been found that the following instructions may fail:

LCP (6662) clear line printer character flag.

LLC (6664) load line printer print buffer and the micro-programmed combination of the above.

LPC (6666) clear flag, then load print buffer.

This situation occurs because the +3V shown on print LP-8-P-01 positive interface (or LP08-N-01 negative interface) connected to B05 pins K2 and E2 does not exist in the wiring.

To correct this problem, add a wire from B05 K2 to B06 A1. Some LP08's had a wire during production but it may be to the wrong pin, make sure it is as started above.

This correction should be made to all positive and negative bus LP08 interfaces.

A formal ECO to correct this will be issued. (ECO #LP08-0024)

SUPPLEMENTAL ACTION TAKEN

- ECO LP08 - 024
- MCN _____
- TECH TIP _____
- OBSOLETE _____

COMPANY CONFIDENTIAL

Title LP08 VFU PROBLEMS						Tech Tip Number LP08-TT-2		
All	Processor Applicability					Author AL SHIMER	Rev 0	Cross Reference
	CU					Approval HAROLD LONG	Date 1/12/73	

1. Some intermittent problems on LP08 printers with the VFU option have been caused by a missing pull up resistor. The VFU requires 9 pull up resistors on connector module loc. A14, in printer logic. The missing 100 - - resistor is from PTS. 11 to 122.

2. VFU diagnostic (Maindec 08-DILPD) was released to the program library November 28.

3. An MCN for LP08 test (Maindec 08-DILPS) has been issued for printers with VFU.

<u>LOC</u>	<u>FROM</u>	<u>TO</u>
0035	7775	7774
0734	0350	0367
0750	0177	0001
0767	XXXX	0177

Title SERIAL PRINTER INTERRUPT CONTROL						Tech Tip Number LP08- TT-3		
All X	Processor Applicability					Author HAROLD LONG	Rev 0	Cross Reference
						Approval BILL CUMMINS	Date 02/16/73	

Setting interrupt enable is standard with serial printer interfaces; the rationale behind this convention is that serial processor devices (i.e., console TTY's) do not have interrupt enable/disable control and hence would interrupt on any flag. Therefore, assigning the printer as console output only requires redefining either its lot or inserting a simple software patch.

Initialize from the processor causes the interrupt enable flip-flop (M205 in A07) to set (Print 7606290-0-02) on power up. In order to run a program, such as focal, with the interrupts on, the line printer must be on line and ready. It would be desirable to clear the interrupt enable flip-flop with initialize to be able to run programs with interrupts without making patches to the software.

The following changes will clear the interrupt enable flip-flop:

	<u>RUN</u>	<u>ADD</u>	<u>DELETE</u>
+ 3V	A07P1 to A07L2		X
+ 3V	A07U1 to A07P1		X
+ 3V	A07P1 to A07L2	X	
INIT L	A05K1 to A07T2		X
INIT L	A05K1 to A07P1	X	
+ 3V	A07U1 to A07T2	X	

digital	FIELD SERVICE TECHNICAL MANUAL				Option or Designator
	12 Bit <input checked="" type="checkbox"/>	16 Bit <input type="checkbox"/>	18 Bit <input type="checkbox"/>	36 Bit <input type="checkbox"/>	LP12

Title HAMMERS FIRE ON POWER UP OR POWER DOWN				Tech Tip Number LP-12-TT-1	
All		Processor Applicability	Author	Rev	Cross Reference
12			H. Long	0	
			Approval	Date	
			H. Long	8-17-72	

This is caused by incorrect sequencing. Interlock Relay (K2) contacts don't make and break cleanly and more important; simultaneously.

Periodic cleaning and adjustment or replacement of K2 will eliminate this problem. Remember! Adjust the relay so that the contacts make and break simultaneously. This can be accomplished by visually checking or dual ohmeter readings.

Title ANALEX 4000 GARBAGE AND PAPER RUNAWAY				Tech Tip Number LP12-TT-2	
All		Processor Applicability	Author	Rev	Cross Reference
X			BENOIT DIONNE		
			Approval	Date	
			A. SHIMER	9/27/73	

PROBLEM DESCRIPTION - Analex 4000 Line Printer aborts printing after "end Half Line Pulse" signal, then keeps on normally, one line being garbaged. Printer may also go into paper runaway.

PROBLEM ANALYSIS - Shuttle photocells are an integral part of input biasing circuit for photocell amplifiers (Data LSS Schematic). Photocell resistances will vary between units, and are also affected by ambient light. Conditions could be such that because of mechanical instability in shuttle linkage; they will output noise after turning on, resetting "shuttle complete flip-flop" which will then enable "end half line pulse".

ACTION TAKEN - Lowering input impedance of Data LSS photocell amplifier to a predictable value by adding a 12K resistor between base and ground of input transistor. This mod was tried when unit was at fault and successfully solved problem.

NOTE - Same solution could be applied to other photocell circuitry (i.e., Feed, Code Wheel), should they become erratic.

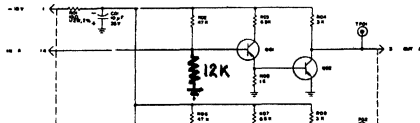

COMPANY CONFIDENTIAL

Title						HIGH FAILURE RATE OF ANALEX 4000 P.S.						Tech Tip Number LP12-TT-3																	
All						Processor Applicability						Author S. LaMotte						Rev 0						Cross Reference					
8		9		10														Approval Lou Nay		Date 4/17/74									

The Analex 4000 Lineprinter, has demonstrated a high failure rate of power supplies. This is an expensive failure, since the power pack cost over \$3,200.

It has been noted that the incorporation of a super muffin fan greatly improves the reliability of the power pack. The fan should be placed so the air flow is down, across the transformer. The dimensions of the muffin fan are so close to those of the printer frame that no screws are necessary.

- (1) Fan, Muffin Super-Pt #12-05033
- (2) Wiring connection is to terminal screws 1 and 2 of terminal strip TB1.

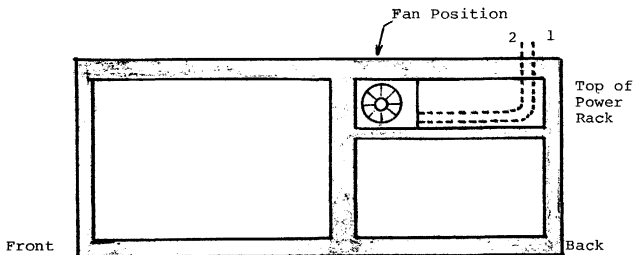

digital	FIELD SERVICE TECHNICAL MANUAL				Option or Designator
	12 Bit <input checked="" type="checkbox"/>	16 Bit <input checked="" type="checkbox"/>	18 Bit <input checked="" type="checkbox"/>	36 Bit <input checked="" type="checkbox"/>	LS01

Title Centronic Printer Model 101 - Part # Confusion				Tech Tip Number LS01-TT-1	
All Processor Applicability		Author B. Lawrence		Rev 0	
X		Approval B. Dimbat		Date 6/28/73	
				Cross Reference	

Subject: Two different parts with the same DEC part #.

Centronic printers model 101 with serial numbers 2105 or lower are 6 level ASCII code printers. Printers with serial numbers 2106 and higher are 8 level ASCII code printers.

The 6 level and 8 level ASCII logic cards are carried under the same 29 part number. The way the printers are now, 8 level ASCII cards cannot be used in the 6 level ASCII printers. The 6 level ASCII cards can be used in 8 level ASCII printers. The addition of 2 jumper wires in the 6 level ASCII printers will allow them to use 8 level ASCII Logic cards. This way, modules can be interchanged and modules can be intermixed. The jumpers are as follows:

J7 pin 5 to J6 pin L (DS8)
J7 pin 6 to J6 pin E (DS7)

These jumpers can be put underneath the bottom of the Component Board Assy. Connector Board.

The Centronic part numbers for 6 level ASCII modules are as follows:

Electronic Card #1 - 63001030
Electronic Card #2 - 63001033

The Centronic part numbers for 8 level ASCII modules are as follows:

Electronic Card #1 - 63002302-2
Electronic Card #2 - 63002303-2

The Dec part numbers are as follows:

Electronic Card #1 - 29-19567
Electronic Card #2 - 29-19568

Title										Tech Tip				
CENTRONICS PRINTER CLEANING PROCEDURE										Number		LS01-TT-2		
Processor Applicability										Author		Cross Reference		
All										John Woelbern		Rev	0	
x										Approval		B. Lawrence	Date	2/6/74

The timing fence on the Centronics 101 and 101A printers can be destroyed by cleaning it with a solvent. The correct procedure, which is not mentioned in the 101 or 101A manuals, is to use a dry, clean cloth or mild soap solution, if necessary.

Title										Tech Tip				
CENTRONICS PRINTER P.M. PROCEDURE										Number		LS01-TT-3		
Processor Applicability										Author		Cross Reference		
All										Bud Lawrence		Rev	0	
x										Approval		Dale Staube	Date	4/24/74

The following P.M. is issued as a Tech Tip to speed the time in which it will reach the Field. The majority of it is written by CENTRONICS.

Frequency:	Quarterly - 3 months or 232 million characters	
	Semi-Annual - 6 months or 464 million characters	DEC PART NO.
Tools required:	Nut Drivers	
	5.5 mm -----	29-19886
	6 mm -----	29-19887
	8 mm -----	29-19888
	10 mm -----	29-19889
	Hex Keys	
	1.5 mm -----	29-19895
	2.0 mm -----	29-19896
	3/32 in. -----	29-19898
	5mm -----	29-19897
	Spanner for solenoid locknut --	29-19890
	Jewlers Eye Loop -----	29-20065
	Open End Wrenches	
	5 x 8 mm	29-19891
	5.5 x 7 mm	29-19892
	6 x 7 mm	29-19893
	8 x 10 mm	29-19894
	Set of Decimal Feeler Gauges--	29-13515
Test Equipment:	Centronics Mini-Exerciser ----	29-21016
Manuals Required:	Centronics 101 or 101A Technical Manual	
Lubricant Recommended:	Grease, Lubriplate 110 or NLGI-3	
	3 in 1 oil,	
	Spray lubricant cleaner	
Cleaning Material:	Two soft clean cloths, medium bristle	
	cleaning brush, freon cleaning solution	
Time Required:	Quarterly 1 1/2 hours (approximately)	
	Semi-Annual 2 hours (approximately)	

NOTE: DO NOT USE FREON ON TIMING FENCE!

digital	FIELD SERVICE TECHNICAL MANUAL				CPI Option or Designator
	12 Bit <input checked="" type="checkbox"/>	16 Bit <input checked="" type="checkbox"/>	18 Bit <input checked="" type="checkbox"/>	36 Bit <input checked="" type="checkbox"/>	LS01

Title CENTRONICS PRINTER P.M. PROCEDURES				Tech Tip Number LS01-TT-3	
All X		Processor Applicability		Author Bud Lawrence Rev 0	
				Approval Dale Staube Date 4/24/74	
				Cross Reference	

QUARTERLY P.M. (101, 101A)

Note
Never apply any lubricants to either the forward or reverse clutch surfaces.

STEP	REFERENCE*	PROCEDURE	CHECK APPROPRIATE BOX			
			OVERVIEW	MINUTE	1/2 HR	1 HR
1		Perform steps 1A to 1H to verify printer operation.				
1A		Insert Centronics mini-exerciser into I/O connector or run IS diagnostic.				
1B		Press ON/OFF switch.				
1C		Press SELECT switch.				
1D		Allow several forms of data to be printed.				
1E		Despict the printer by pressing the SELECT switch again.				
1F		Press TOP OF FORM switch to verify operation. Raise reader bracket HH-57 to check paper tape alignment with light holes.				
1G		Create a paper out condition by removing all but one form from the printer. Press line feed button until PAPER OUT indicator turns on (101A Only). On 101 Printers, rotate paper feed knob HF-99 until PAPER OUT indicator turns on.				
1H		Select the printer. Printing should occur only when FORMS OVERRIDE switch is pressed. Turn power off.				
1I	A-3 & A-4	Lower the left and right cover assemblies.				
1J	A-5	Remove front cover (4 screws).				
2	HD-33, HD-34, HE-32	Examine damper stoppers for loose pads or wear.				
3	HE-52	Clean lining fence with clean soft cloth. Use mild detergent only if needed. CAUTION: DO NOT USE ANY ORGANIC SOLVENT.				
4	SECT. 5.2.13.3	Check gap alignment between fiber optic head and timing fence. Ensure that uniform gap of 0.012 to 0.020 in. exists. Adjust if necessary.				
5	HF-99 & FIG. 8-6 (a,b)	Pull paper feed knob to disengage form feed mechanism. Rotate knob in both directions to ensure that pin feed mechanism moves freely in both forward and reverse directions.				

*101 or 101A Technical Manual - Drawings HA through HL are found in section 8 of that manual.

PAGE 383	PAGE REVISION 0	PUBLICATION DATE April 74
-----------------	------------------------	----------------------------------

Title CENTRONICS PRINTER P. M. PROCEDURES						Tech Tip Number LS01-TT-3	
Processor Applicability						Author Bud Lawrence Rev 0	
All X						Approval Dale Staupe Date 4/24/74	
Cross Reference							

QUARTERLY P.M. (101, 101A) CONT.

STEP	REFERENCE	PROCEDURE	CHECK APPROPRIATE BOX			
			Checkup	Adjust	Lubricate	Re-Adjust
6	SECT. 5.2.8.3	Ensure pin feed belts are aligned. Adjust set-screws if necessary.				
7	FIG. 5-7	HEAD ASSEMBLY				
7A	SECT. 5.2.13.2	Adjust head assembly for maximum gap between head and platen. Remove head from printer carriage and head covers. Clean print wires on both sides of jewel with freon and medium bristle cleaning brush.				
7B		With the aid of a spanner wrench, align the end of the print wires between flush and .002 inch protruding from jewel.				
7C		Reassemble the head on the printer carriage.				
8	HA-45	Oil gap between gib and head.				
9	HA-2	Grease head adjusting knob eccentric shaft located under HA-2.				
10	SECT. 5.2.2.3	CARRIAGE MECHANISM				
10A		Check for play between carriage and guide bar HE-8 and also guide plate HE-23. Adjust if necessary.				
10B	HA-46, HA-48	Check for play between carriage and head bracket. Adjust screws if necessary. (Be sure that head adjusting knob is free to turn.)				
10C	HE-8, HE-23	Oil and then wipe clean, carriage guide bar and plate.				
11	SECT. 5.2.9.3	FORM FEED MECHANISM				
11A	HH-14, HH-81	Lubricate Form Feed (FF) solenoid slide and FF clutch with spray lubricant cleaner.				
11B	HH-23, HH-74	Check for back play on cam backstop pawl HH-74, which rides on HH-23. Adjust if necessary by repositioning stop cam HH-23.				
11C	HH-14, HH-81	Check gap between the stop of FF clutch inside cam HH-14 and the solenoid slide on HH-81. Gap should be 0.007 to 0.011 inch. Adjust if necessary by loosening screws (HH-83) and positioning FF clutch magnet (HH-80).				
11D	HH	Oil all shafts on form feed unit.				
11E	HH-71	Oil form feed motor in appropriate slot.				

CPL

digital	FIELD SERVICE TECHNICAL MANUAL				Option or Designator
	12 Bit <input checked="" type="checkbox"/>	16 Bit <input checked="" type="checkbox"/>	18 Bit <input checked="" type="checkbox"/>	36 Bit <input checked="" type="checkbox"/>	LS01

Title CENTRONICS PRINTER P.M. PROCEDURES				Tech Tip	
				Number LS01-TT-3	
Processor Applicability		Author Bud Lawrence	Rev 0		Cross Reference
All X		Approval Dale Staupé	Date 4/24/74		

QUARTERLY P.M. (101, 101A) CONT.

STEP	REFERENCE	PROCEDURE	CHECK APPROPRIATE BOX			
			UNOILED	MISSED	UNOILED	MISSED
12	HH-28, HA-36, HB-49, HB-48, (2 belts)	Check tension on belts. Adjust if necessary to insure sufficient tauntness as specified in section 5 of the manual.				
13	HB (a), HB (b)	DRIVE MECHANISM				
13A	HB-51, HB-83	Check for end play on forward and reverse clutch. Adjust both HB-51 brackets to eliminate any end play.				
**13B	HB-87, HB-83, HB-92, SECT. 5.2.3.3 (Para. d)	Check for 0.008 to 0.012 inch gap between the rotor and armature on the forward and reverse clutches. Adjust if necessary. CAUTION: DO NOT APPLY ANY LUBRICANTS TO FORWARD OR REVERSE CLUTCH SURFACES.				
13C	HB, HE	Oil intermediate shaft HB-80 at bushings HE-7 (two locations)				
14	FIG. HI	RIBBON FEED MECHANISM				
14A	HI-44	Check for worn pads on left and right ribbon holding plates. Replace if necessary.				
14B	HI-76	Oil ball bearing in slip clutch on ribbon drive shaft unit.				
14C	HI-4, HI-5	Grease clutch spring and sleeve				
14D	HI-30, HI-103	Grease driving slide shaft ends at bushings HI-30 both ends.				
14E	HI	Grease all metal to metal gear surfaces.				
14F	HI	Check all gears for proper meshing and wear.				
14G	HI-103, SECT. 5.2.10.2 (para. 5.c)	Verify that both ribbon spools rotate freely when driving slide shaft HI-103 is in neutral position.				
14H	SECT. 5.2.10.2 (para. 6.a)	Engage driving slide shaft with bevel gear right HI-43. Manually move head carriage and verify proper ribbon tracking.				
14I	SECT. 5.2.10.2 (para. 6.b)	Engage driving slide shaft with bevel gear left HI-59. Manually move head carriage and verify proper ribbon tracking.				
**15	A-3, A-4, A-5	Reinstall and align front cover with side covers.				
**16		Repeat steps 1A thru 1H to verify correct printer operation. During step 1D, set the head adjusting knob HA-32 for good print quality.				

**Quarterly P.M. only

PAGE 385	PAGE REVISION 0	PUBLICATION DATE April 1974
-----------------	------------------------	------------------------------------

Title CENTRONICS PRINTER P.M. PROCEDURES						Tech Tip Number LS01-TT-3	
All Processor Applicability				Author Bud Lawrence		Rev 0	
x				Approval Dale Staup		Date 4/24/74	
Cross Reference							

SEMI-ANNUAL P.M. (101, 101A)

For semi-annual P.M., perform the following steps in addition the quarterly P.M. steps:

STEP	REFERENCE	PROCEDURE	CHECK APPROPRIATE BOX			
			CLEANED	NOISE RED	LUBED	REPAIRED
17	HB (a), HB (b)	DRIVE MECHANISM NOTE: For ease in servicing the drive mechanism remove only one clutch and armature assembly at a time.				
17A	SECT. 5.2.3.2 (para. E1)	Remove forward clutch rotor HB-82, and clutch armature, HB-83, from drive mechanism.				
17B		Examine clutch surfaces and either clean with freon or replace if excessively worn.				
17C		Apply a light film of lubricant on the exposed end of drive shaft HB-50.				
17D	SECT. 5.2.3.3 (para. D)	Reassemble forward clutch and armature. Check clutch gap for 0.008 to 0.012 inch between clutch surfaces. Adjust if necessary.				
17E	SECT. 5.2.3.2 (para. E2)	Remove reverse clutch rotor HB-87 and reverse clutch armature HB-83 from drive mechanism.				
17F		Examine clutch surfaces and either clean with freon or replace if excessively worn.				
17G		Apply a light film of lubricant on the exposed end of drive shaft HB-50.				
17H	SECT. 5.2.3.3 (para. D)	Reassemble reverse clutch and armature. Check clutch gap for 0.008 to 0.012 inch between clutch surfaces. Adjust if necessary.				
17I		Eliminate end play on forward and reverse clutch by adjusting both bushing brackets HB-51.				
18	A-3, A-4, A-5	Reinstall and align front cover with side covers.				
19		Repeat steps 1A thru 1H to verify correct printer operation. During step 1D set the head adjusting knob HA-32 for good print quality.				

CPL

digital	FIELD SERVICE TECHNICAL MANUAL				Option or Designator
	12 Bit <input checked="" type="checkbox"/>	16 Bit <input checked="" type="checkbox"/>	18 Bit <input checked="" type="checkbox"/>	36 Bit <input checked="" type="checkbox"/>	LS01

Title					Tech Tip	
CENTRONICS PRINTER 101/101A					Number	
Processor Applicability					LS01-TT-4	
Author	R. LAWRENCE			Rev 0		Cross Reference
Approval	P. LAWRENCE			Date 2/6/74		

Model 101/101A Wiring Harness Change.

Reference: Centronics FCB #106/107 for the printer Model 101/101A.

To increase the current-carrying capacity of the ± 12 volt and +5 volt return line in the Model 101/101A printers, the wires to Pin 1 and Pin 8 of J12 are to be interchanged. Wire W64 should be connected to Pin 1 when you complete the switch. Pin 1 on the connector board is the heavier run.

J12 is the connector which plugs into the rear of the connector board #63002332 on the 101/101A printer.

This change updates wiring diagram #63002333 from Revision B to C and Interconnection Diagram #63002330 from Revision A to B.

This keeps the mother board from lifting etches when a short occurs.

Title Centronics Printer Intermediate Shaft						Tech Tip Number LS01 - TT-5		
All X	Processor Applicability					Author B. Lawrence	Rev 0	Cross Reference
						Approval B. Lawrence	Date 2/6/74	

INTERMEDIATE SHAFT W/PULLEY, MODEL 101/101A

The Tech Tip is divided into two parts: (1) details for the preventive maintenance procedure as applied to the intermediate shaft w/pulley (HB-80), as well as, (2) the removal/replacement of this shaft.

PART 1 Preventive Maintenance of Intermediate Shaft Assembly

A. MATERIAL REQUIRED

1. Technical manual
2. Screwdriver, flat blade (medium)
3. 3-in-1 oil (or equiv.)

B. TIME REQUIRED: ¼ - Hr.

C. PREPARATION

1. Remove all external accessory covers, necessary screws and washers including screws to cover assembly, base (Figure 4-2, Section 8).
2. Remove entire cavity assembly 63001105-1 at back of printer.
3. Remove power driver board assembly 63002242 at front of printer.
4. Tilt machine backwards, 90 degrees from site position, to expose underneath portion of printer.

D. PREVENTIVE MAINTENANCE OF INTERMEDIATE SHAFT

NOTE: That preventive maintenance of this assembly is applied on a quarterly basis and must be maintained to ensure proper operating function.

1. Apply 3-in-one oil (or equiv.) to felt washers (HB-26) located on shaft in front of bushings (HB-7).

digital	FIELD SERVICE TECHNICAL MANUAL				Option or Designator
	12 Bit <input checked="" type="checkbox"/>	16 Bit <input checked="" type="checkbox"/>	18 Bit <input checked="" type="checkbox"/>	36 Bit <input checked="" type="checkbox"/>	LS01

Title Centronics Printer Intermediate Shaft					Tech Tip Number LS01-TT-5
All	Processor Applicability			Author B. Lawrence	Rev 0
X				Approval B. Lawrence	Date 2/6/74
					Cross Reference

PART 2 - Removal/Replacement of Shaft (HB-80)

A. MATERIALS REQUIRED

1. Technical manual
2. 10 millimeter wrench (open-end)
3. Screwdriver, flat blade (medium)
4. 5/64-inch allen-wrench
5. 3-in-1 oil (or equiv.)
6. Loctite (or equiv.)

B. TIME REQUIRED: 1 HR.

C. PREPARATION

1. Perform steps 1 through 4 as found in Part 1, Para. C.

D. PRINTER PARTS REMOVAL

1. Remove intermediate pulley (HB-30) by removing nut (HB-28) and washer (HB-29). Slide belt (HB-48) off the pulley prior to removal.
2. Loosen pulley (HB-22) on intermediate shaft (HB-80) by loosening two set-screws (HB-23). Slide off pulley belt (HB-48).
3. Pull out pinned pulley and shaft (HB-80) toward front of printer. This step will free pulley (HB-22) and felt washers (HB-24, 26).

E. INSTALLATION OF INTERMEDIATE SHAFT W/PULLEY (REF: Fig. 8-6 (HE)).

Perform the following steps prior to installing pinned pulley and shaft (HB-80).

1. Check that shaft bushings (HE-7) are secure in printer machine support.

Title						Tech Tip					
Centronics Printer Intermediate Shaft						Number LS01-TT-5					
All		Processor Applicability				Author B. Lawrence		Rev 0		Cross Reference	
X						Approval B. Lawrence		Date 2/6/74			

2. Secure loose bushings by using loctite (or equiv.) on outside surfaces that contact base frame of printer. Clean surrounding support holes prior to installation. Avoid loctite touching inside surfaces of bushings where shaft rotates. Clean interior shaft hole of bushing.
3. Lubricate inside surfaces of bushings and shaft with 3-in-1 oil (or equiv.) (Refer to Figure 1)
4. Add a few drops of oil (3-in-1) (or equiv.) to felt washers (JB-24, 26) of shaft prior to installation.
5. Ensure that at least one set-screw (HB-23) of pulley (HB-22) is installed in groove of shaft prior to tightening.

F. RE-ASSEMBLY

1. Reverse para. C, steps 1 through 3 but note the following:
 - a. When reversing step 1 to install pulley (HB-30), make sure pulley belt (HB-48) is placed over the hole when pulley shaft (HB-27) is inserted so that it can slide over spur gear of pulley (HB-30).

G. POINTS TO CHECK

1. Ensure that main motor pulley (HB-91) is in direct alignment with intermediate shaft pulley (HB-22) by adjusting, if necessary, motor and bracket (HB-9) parallel to front paper pan (HB-89) by sighting straight down on the top of two slotted-head screws (HB-12) of the motor mounting bracket (HB-9) and align these screws parallel with the front of the paper pan.
2. With forward and reverse pulley belts (HB-48, 49) and main motor pulley belt (HB-48) in place, adjust eccentric on intermediate pulley (HB-30) shaft when main motor is running. The adjusting screw is located on shaft (HB-27) toward back of printer when shaft and pulley (HB-30) is inserted properly for forward clutch pulley drive. Test is based upon smooth running performance of gearing with minimum noise. When satisfactory conditions are met, lock up nut (HB-28) and lock washer (HB-29) with 10 millimeter open-end wrench while at the same time holding correct adjusting screw position with screwdriver.
3. Adjust belt tensions, if required. (Refer to technical manual Section 5, page 5-14).

digital	FIELD SERVICE TECHNICAL MANUAL				Option or Designator
	12 Bit <input type="checkbox"/>	16 Bit <input checked="" type="checkbox"/>	18 Bit <input checked="" type="checkbox"/>	36 Bit <input type="checkbox"/>	LS01

Title Centronics Printer Damper Spring					Tech Tip Number		LS01-TT-6	
All X	Processor Applicability				Author	B. Lawrence	Rev	0
					Approval	B. Lawrence	Date	2/6/74
							Cross Reference	

The spring (H-31) on the damper assembly has been changed. However, the old spring has not been obsoleted and is completely interchangeable with the new type spring.

The old type spring is "L" shaped, and the new type spring is "U" shaped. The Centronic part number for both springs is the same: 525661001. The DEC part number is: 29-19583. This part number will get you an "L" shaped spring.

Title Centronics Printer - Video Amplifier					Tech Tip Number		LS01-TT-7	
All X	Processor Applicability				Author	J. R. Kriesick - FR	Rev	0
					Approval	Bud Lawrence	Date	12/28/73
							Cross Reference	

1. Adjust or check adjustment of timing fence and fiber optics bundle according to the procedure in Centronics Technical Manual, or LS01-TT-3, Step #4.
2. Checking input to Video amplifier (Reference Schematic of the Video Amplifier).
 - A. Place scope probe at the junction of R1, base of Q1, and the photo cell.
 - i. Set up scope channel 1, A.C.; 20 MV/CM at 1 MS/CM using a 10x probe.
 - ii. An input signal of approximately .5 to .6 VPP will be observed by manually moving the video amp. assembly along the timing fence.

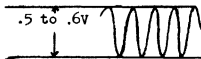

Title						Centronics Printer - Video Amplifier		Tech Tip Number		LS01-TT-7	
Processor Applicability						Author		J. R. Kriesick - FR		Rev 0	
All X						Approval		B. Lawrence		Date	
										Cross Reference	

3. Output of the Video Amp. (Reference schematic of Video Amp.)

A. Place scope probe at the junction of R6, R7, and the collector of Q3, or at P11 pin 6.

i. Set up scope channel 1, A.C., .2V/CM at .5 MS/CM using X10 probe.

ii. Manually or under program control move the video amp along the timing fence. A good video amp will produce a sawtooth output signal with an amplitude of approximately 4 volts.



Title						Centronics Line Feed Delay Problem		Tech Tip Number		LS01-TT-8	
Processor Applicability						Author		Bill Kochman		Rev 0	
All X						Approval		E. Lawrence		Date 2/6/74	
										Cross Reference	

Many line feed problems can be corrected by increasing the LF delay from 15ms to 18 ms. Adjust R54 on Electronic Cord #1, scope ME 17, one shot. This tech tip applies to the Centronics Model 101/101A.

CPL

digital	FIELD SERVICE TECHNICAL MANUAL				Option or Designator
	12 Bit <input checked="" type="checkbox"/>	16 Bit <input checked="" type="checkbox"/>	18 Bit <input checked="" type="checkbox"/>	36 Bit <input checked="" type="checkbox"/>	LS01

Title CHANGE R-38 ON POWER DRIVER BOARD					Tech Tip Number LS01-TT-9	
All Processor Applicability			Author B. LAWRENCE		Rev 0	
<input checked="" type="checkbox"/>	<input type="checkbox"/>	<input type="checkbox"/>	<input type="checkbox"/>	<input type="checkbox"/>	Cross Reference	
			Approval B. LAWRENCE		Date 2/6/74	

STARTING AT ARTWORK REVISION C9* ON POWER DRIVER BOARD #63002242, THE VALUE OF RESISTOR R38 IS BEING CHANGED AS FOLLOWS:

FROM: 180 OHMS, 2W, 10%
TO: 470 OHMS, 2W, 10% DFC #13-00321-00

THIS INCREASE IN THE VALUE OF R38 WILL REDUCE THE POWER DISSIPATION OF R27.

Title ON/OFF AUTOMATIC MOTOR CONTROL					Tech Tip Number LS01-TT-10	
All Processor Applicability			Author Dale Staupé		Rev B	
<input checked="" type="checkbox"/>	<input type="checkbox"/>	<input type="checkbox"/>	<input type="checkbox"/>	<input type="checkbox"/>	Cross Reference	
			Approval B. Lawrence		Date 4/29/74	

Centronics Corporation has come out with an option for their Models 101/101A printers which shuts off the AC Voltage to the main drive motor during standby operation, 6 to 10 seconds after printing data or a paper movement command. The main drive motor is turned on immediately upon receiving characters to be printed or a paper movement command. This option saves wear on mechanical parts and reduces standby noise. With the addition of this option, the life of the printer is considerably longer as well as the mean time between failures. This option is highly recommended for all machines. The branch should sell the option to the customer for \$150, (this is the installed price) whether the machine is on contract or not. If the customer doesn't want to buy the option, it would benefit the branch to install this option at DFC's cost, \$50. Either way, the life of the printer is increased and the number of service calls should decrease. The branch can order the option from Maynard, stockroom 17. Installation time is approximately 2 hours.

The part numbers are as follows:

DEC PART NO.
29-21015

VENDOR PART NO.
63-011130-01

Instructions for installing the above option are contained in MAINTENANCE AND FIELD CHANGE BULLETIN FOR CENTRONICS, DEC-PS-HPTRA-A-D.

Title CLUTCH ROTORS						Tech Tip Number LS01-TT-11		
All	Processor Applicability					Author Dave Bentley	Rev 0	Cross Reference
X						Approval	Date 7/1/74	

THERE HAS BEEN SOME CONFLICT ON CLUTCH ROTORS ORDERING AND INSTALLATION. PLEASE NOTE THAT ON MODEL 101 PRINTERS THERE ARE TWO DIFFERENT PART NUMBERS.

- 1) FORWARD CLUTCH ROTOR CEN#525096001 DEC# 29-20746
- 2) REVERSE CLUTCH ROTOR CEN#525890001 DEC# 29-20749

THESE CLUTCH ROTORS SHOULD NOT BE INTERCHANGED BECAUSE IF THEY ARE THEY WEAR MUCH FASTER.

TO CORRECTLY INSTALL CLUTCH ROTORS FIRST CHECK OUT ITS LINING. THE FORWARD CLUTCH ROTORS LINING IS MUCH LIGHTER IN COLOR, WHILE THE REVERSE CLUTCH IS DARKER. ALSO NOTE THAT THEY ARE MADE OF DIFFERENT MATERIAL. THIS IS THE ONLY DIFFERENCE BETWEEN THE TWO.

CARE SHOULD BE TAKEN WHEN REPLACING ROTORS TO PREVENT EXCESS WEAR AND FREQUENT REPLACEMENT.

Title FIELD CHANGE BULLETINS FROM CENTRONICS						Tech Tip Number LS01-TT-12		
All	Processor Applicability					Author Jerry Sarasin	Rev 0	Cross Reference
X						Approval Dale Staupé	Date 7/1/74	

MAINTENANCE AND FIELD CHANGE BULLETIN FOR CENTRONICS MODEL 101/101A PRINTERS

is a DEC publication, DEC-FS-HPTRA-A-D, which consolidates Field Change Bulletins that have been issued by Centronics Corporation and is available through Technical Publications Stockroom PK1, Maynard, Mass.

CPC

digital	FIELD SERVICE TECHNICAL MANUAL				Option or Designator
	12 Bit <input checked="" type="checkbox"/>	16 Bit <input checked="" type="checkbox"/>	18 Bit <input type="checkbox"/>	36 Bit <input type="checkbox"/>	LS08

Title				CENTRONICS PRINTER INTERRUPT CONTROL		Tech Tip Number		LS08-TT-1	
All		Processor Applicability		Author		Rev		Cross Reference	
X				LEN MALAND		0			
				Approval		Date			
				BILL CUMMINS		04/19/73			

Setting interrupt enable is standard with serial printer interfaces; the rationale behind this convention is that serial processor devices (i.e., console TTY's) do not have interrupt enable/disable control and hence would interrupt on any flag. Therefore, assigning the printer as console output only requires redefining either its lot or inserting a simple software patch.

Initialize from the processor causes the interrupt enable flip-flop (M205 in A07) to set (Print 7606290-0-02) on power up. In order to run a program, such as focal, with the interrupts on, the line printer must be on line and ready. It would be desirable to clear the interrupt enable flip-flop with initialize to be able to run programs with interrupts without making patches to the software.

The following changes will clear the interrupt enable flip-flop:

	<u>RUN</u>	<u>ADD</u>	<u>DELETE</u>
+ 3V	A07P1 to A07L1		X
+ 3V	A07U1 to A07P1		X
+ 3V	A07P1 to A07L1	X	
INIT L	A05K1 to A07T2		X
INIT L	A05K1 to A07P1	X	
+ 3V	A07U1 to A07T2	X	

COMPANY CONFIDENTIAL

digital	FIELD SERVICE TECHNICAL MANUAL				Option or Designator
	12 Bit <input checked="" type="checkbox"/>	16 Bit <input type="checkbox"/>	18 Bit <input type="checkbox"/>	36 Bit <input type="checkbox"/>	LS8E

Title M8342 and M8329 IOT SELECTION JUMPERS				Tech Tip Number LS8E-TT-1	
All Processor Applicability		Author J. Blundell		Rev 0	
X		Approval: Purcell		Date 9/5/73	
				Cross Reference LC8E-TT-1	

Volume III of the 8E Maintenance Manual and the M8329 circuit schematic, Rev. C both have mistakes with the jumper numbering for device code selection. The board actually agrees with the drawing below.

The fault symptom will typically be either wrong sense of bits 5 or 6 in the decoded IOT, or MD bit 6 always constant on the omnibus.

The same mistakes have been carried over into the LS8E (M8342) control. The drawing below also applies exactly to the C.S. Rev. 0 of that board.

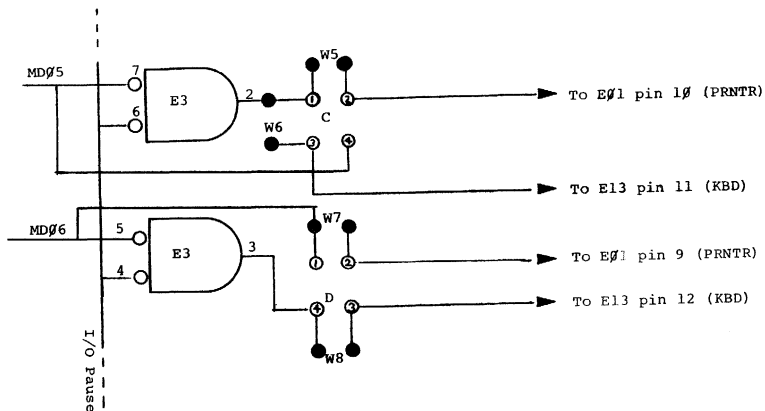

COMPANY CONFIDENTIAL

digital	FIELD SERVICE TECHNICAL MANUAL				Option or Designator
	12 Bit <input checked="" type="checkbox"/>	16 Bit <input checked="" type="checkbox"/>	18 Bit <input type="checkbox"/>	36 Bit <input type="checkbox"/>	LS11-A/B

Title	CENTRONICS LINE PRINTER				Tech Tip Number	LS11-TT-1
All	Processor Applicability	Author	DAVIS HOLMAN	Rev	0	Cross Reference
x		Approval	ART ZINS	Date	8/28/73	

1. Line feed problems either too many or none:

Check that line feed coil not moving on core. If it is, it will impede armature movement. Use a small nylon tie wrap to pull coil tight against back of coil mount bracket.

Residual magnetism builds up in pole piece and armature affecting line feed reliability. This is a D. C. coil so reverse coil wires to change flux direction may work for next six months. Also the manual talks of a brass pole shim which may have pulverized - make shift another.

2. If printer has an RS232-C interface a great deal of the logic can be checked out (logic cycles) if "Recdat" at pin 1 of ME18 (7404) is grounded.
3. The carriage drive mechanism definitely needs lubing, as the sleeve (bearings) wears out quickly. There are felt washers on the gear and pulley drives.
4. Format loop problems stopping one line or more early. If it seems photo diodes are too sensitive, tape part of them off.

COMPANY CONFIDENTIAL

-- NOTES --

digital	FIELD SERVICE TECHNICAL MANUAL				Option or Designator
	12 Bit <input checked="" type="checkbox"/>	16 Bit <input checked="" type="checkbox"/>	18 Bit <input checked="" type="checkbox"/>	36 Bit <input checked="" type="checkbox"/>	LT33

Title CONVERTING ASR-33 TO PDP-8/E				Tech Tip Number LT33-TT-1	
All Processor Applicability		Author Sweeney/Quinn	Rev B	Cross Reference	
X		Approval E. Purcell	Date 7/31/73		

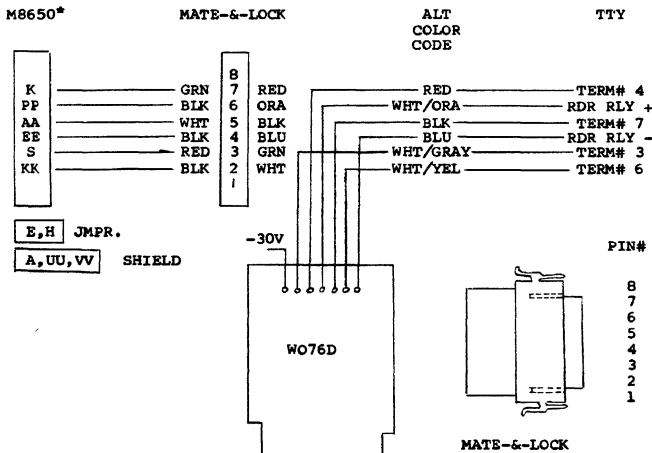

* If the Teletype Control Module is an M865, the split lugs are to be connected to the TTY as follows:

SPLIT LUG#4	=	RDR RLY -
#3	=	TERM #3
#7	=	TERM #4
#5	=	TERM #7
#6	=	RDR RLY +
#2	=	TERM #6

The above chart has been designed to reduce the amount of time you would normally spend cross-referencing several different sets of prints. It is highly recommended that, before applying power to the reconfigured system, you double-check all wiring for correctness. Failure to do so could result in damage to the Teletype Control Module and/or the Teletype.

Title CONVERTING ASR-33 TO PDP 8E (cont)						Tech Tip Number LT33-TT-1	
All Processor Applicability			Author Sweeney/Quinn		Rev B		Cross Reference
X			Approval F. Purcell		Date 7/31/73		

Converting the ASR-33 to the PDP-8/E

Occasionally a customer may request to have an older ASR-33 configured such that it can be used on any 8/E type system.

CAUTION: Prior to performing any rewiring, be certain that the teletype in question has in fact been modified for use on DEC's PDP-8 family of computers. (Reference the field service technical manual, LT33-TT-3)

Title ASR CONVERSION 280V, 50Hz V.S. 115V, 60Hz						Tech Tip Number LT33-TT2	
All Processor Applicability			Author J. Blundell K. Quinn		Rev C		Cross Reference
X			Approval D. Staupé		Date 7/10/74		

- 1) Disconnect and remove the step down transformer from the teletype base.
- 2) Remove the AC supply lead from the terminal strip inside the teletype.
- 3) Connect the new AC power cord to those same terminals, white to C, black to #1 and green to a chassis screw.
- 4) If the motor is rated for other than desired Hz rating, it must be replaced with one rated for the proper cycle operation.
(Not necessary if motor is already 50/60 Hz).
- 5) Change the fuse to correspond to the motor being used.
- 5) Proper operating speed is determined by the ratio of the belt driving gear and its pinion gear: these must be replaced in this conversion.

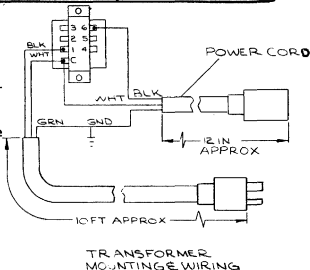

The parts required for conversion can be specified as follows:

Part	Vendor Part#		DEC Part#	
	60Hz	50Hz	60Hz	50Hz
Belt driving gear	181420	181855	29-11417	29-11431
Pinion gear	181411	181851	29-11412	29-11428
Motor	181870	182267	29-11432	29-11448
AC power cord	182510		29-16755	
Plug 220V			90-08853	
Fuse	MDL 2.25	320246	29-19119	12-11425

Installation charges are based on time and material; there is no fixed charge for this conversion. Price for parts is approximately \$100.

PAGE 400

digital	FIELD SERVICE TECHNICAL MANUAL				Option or Designator
	12 Bit <input checked="" type="checkbox"/>	16 Bit <input checked="" type="checkbox"/>	18 Bit <input type="checkbox"/>	36 Bit <input checked="" type="checkbox"/>	LT33

Title	PRICING POLICY FOR TELETYPE CONVERSIONS			Tech Tip Number	LT33 TT-3
All <input checked="" type="checkbox"/>	Processor Applicability	Author	Walter MacKenzie	Rev	0
		Approval	W. Cummins	Date	7-31-72
				Cross Reference	

The following policies and prices have been established as of June 1969 for modifying customer owned Teletypes for use with DEC computers.

TELETYPE MODEL	CONVERSION KIT ONLY (A)	DEC CONVERSION - Parts and Labor (B)
KSR-33	\$100.00	\$200.00
ASR-33	\$125.00	\$300.00
KSR-35	\$125.00	\$300.00
ASR-35	NOT AVAILABLE	\$1000.00

Conversion Kits - Do It Yourself

Each conversion kit, as listed above in column A, will include all necessary parts and installation instructions.

Conversions Done By DEC Personnel

Conversion prices, as listed in column B above, are based upon the assumption that the customer owned Teletype presented to DEC for conversion is in good operating order. Labor and/or parts required to restore a unit to good working condition will be billable at DEC's then prevailing rates.

Field Service mileage rates shall also apply in addition to the installation charges listed above.

DEC will provide a 30 day warranty of the conversion only.

The conversion kit for the ASR-35 shall remain proprietart in nature. This is based upon the fact that DEC has made extensive engineering investments in creating this modification and customers should expect to reimburse us for that effort.

COMPANY CONFIDENTIAL

Title						ASR 33 MODIFICATION FOR FANFOLD TAPE		Tech Tip Number		LT33 TT# 4	
All		Processor Applicability				Author		Rev		Cross Reference	
X						Approval W. Cummins		Date		7-31-72	

At times, the ASR 33 punch will not accept fanfold tape. To correct this, install the 185705 tape guide M00 Kit. These kits are available in the Field Service Stockroom and are priced at \$9.45.

Title						ASR 35/81/M707 FAILURES		Tech Tip Number		LT33 TT#5	
All		Processor Applicability				Author		Rev		Cross Reference	
X						Approval W. Cummins		Date		7-13-72	

ASR 35/81/M707 FAILURES

Erratic failure of the M707 Teletype transmitter module has been a problem when an ASR 35 is connected to an 81; the M707 output transistor (Q3) (6534) is blown and the ASR 35 runs open. This will occur following rotation of the mode switch through the KT, T positions. Excessive transients were suspected and several ECO's have been suggested and implemented.

1. A D664 diode connected in parallel with the 470 ohm resistor from the base of Q3 to 5V on the M707 (cathode to +5V).
2. On the W076 connector card, pin F, change the 750 ohm resistor to 1K, add 3 D671 diodes, pin H (cathode) to -15V, pin I to -5V (cathode), and pin M to ground (cathode).
3. Use of thyrectors or arc suppressors across the selector magnetic terminals.

The specific problem has now been recognized as a circuit peculiarity in the ASR 35 which was overlooked in the design of the M707. The mode switch on the ASR 35 applies a short circuit to -15V at pin AV2 of the M707 (J12H2) as it is rotated between the KT and T positions. Current limiting circuitry was not provided for the 6534 and the excessive current destroys it.

Engineering first suggested that a 100 ohm resistor be inserted in series with the emitter circuit of the 6534 on the M707 and this was done on about 10 machines. It was discovered with further research that the normal 20 ma. marking current for the ASR 35 had been reduced to 11 ma. by this modification. Because teletype operation becomes marginal at 10 ma., it became obvious that this was unacceptable.

A final solution has been determined and will become an ECO:

1. Cut the etch between the 6534 collector and pin AV2 on the M707 and insert a 120 ohm 1/4W resistor in series.
2. On the W076 change resistor R3 (which is connected between pins B and F) from either 750 or 1000 ohms to 820 ohms 1/2W.

CPL

digital	FIELD SERVICE TECHNICAL MANUAL				Option or Designator
	12 Bit <input checked="" type="checkbox"/>	16 Bit <input checked="" type="checkbox"/>	18 Bit <input checked="" type="checkbox"/>	36 Bit <input checked="" type="checkbox"/>	LT33

Title SECURING TELETYPE CABLE TO LOGIC FRAME				Tech Tip Number LT33 TT# 6		
All	Processor Applicability			Author	Rev 0	Cross Reference
	8I			Approval W. Cummins	Date 7-31-72	

The cable from the teletype is dressed under the 8I cabinet, through the large opening and into logic frame slot J12. If the teletype happened to be positioned at the maximum distance which the cable would allow (assuming the logic frame in the normally closed position) or if the cable were to be looped around a caster and an attempt made to pull the logic frame forward, the horizontal stress could easily damage either the block or the W076A connector card. It is necessary that the cable be dressed through the cable clamp at the lower rear corner of the logic frame where the power cables are secured to eliminate this possibility. A second clamp may be desirable at the bottom of the 8I cabinet to assure that sufficient slack exists irrespective of teletype position.

Title ASR 33 READER SYNCHRONIZATION				Tech Tip Number LT33 TT#7		
All	Processor Applicability			Author White/Arsenault	Rev 0	Cross Reference
	8I	8L		Approval W. Cummins	Date 7-31-72	

When ASR 33 Part II Program 3 fails roughly once per complete pass, the failure always occurs in the random stall section of test as a result of the reader fetching an extra character.

This problem is a synchronizing problem which exists in M706 modules of Revision J or earlier. It will be fixed in future revisions via an ECO to the M706. Boards of revision J or earlier can be made to work properly by the addition of a 470 PF capacitor from Pin BN2 of the M706 to ground.

COMPANY CONFIDENTIAL

Title TELETYPE READER POWER SUPPLY						Tech Tip Number LT33-TT-8		
All	Processor Applicability					Author Bill Harrigan	Rev 0	Cross Reference
X						Approval W. Cummins	Date 7-31-72	

A poor electrical connection between the 200 MFD capacitor and the circuit board etch has resulted in failures of the Teletype reader power supply. The symptoms will be either a blown 3 amp fuse or a defective rectifier, the latter resolved only by replacement of the power supply.

The poor connection is caused by the stripping away of etch by the teeth on the star washer used to secure the capacitor to the board. A standard washer should be installed between the star washer and the circuit board to eliminate this problem.

Title TELETYPE PRINTS						Tech Tip Number LT33-TT-7		
All	Processor Applicability					Author Walter MacKenzie	Rev 7	Cross Reference
X						Approval W. Cummins	Date 12/12/73	

A well documented set of prints explaining our modification to teletypes is now available in drafting. You can order these prints under the following numbers:

<u>Number</u>	<u>Revision</u>	<u>Description</u>
7505038-0-7		ASR 33 120V 60HZ
7505039-0-0		ASR 33 340V 50/60HZ
7505040-0-7		KSR 33 240V 50/60HZ
7505041-7-7		KSR 33 120V 60HZ
7505042-0-7		KSR 35 240V 50/60HZ
7505043-0-0		KSR 35 120V 60HZ

COMPANY CONFIDENTIAL

digital	FIELD SERVICE TECHNICAL MANUAL				Option or Designator
	12 Bit <input checked="" type="checkbox"/>	16 Bit <input checked="" type="checkbox"/>	18 Bit <input checked="" type="checkbox"/>	36 Bit <input checked="" type="checkbox"/>	LT33

Title	DIFFERENCES BETWEEN NEW 3300 SERIES TELETYPE AND OLD 33 TS, TU, TBP			Tech Tip Number LT33-TT-10	
	Processor Applicability			Author <u>Ray Alvarez</u>	Rev #
All X			Approval <u>Dick Russell</u>	Date <u>6/25/74</u>	

As of September 1973 DEC has been shipping the new style 3300 series teletype. There are some noted differences between these two models, and apparently some confusion has existed in the field. This tech-tip will help clear up the differences between the two models and also help to update documentation that will follow in the near future.

1) Internal Differences:

The reader power pack on the 3300 mounts within the main teletype case (in the call control unit area) rather than in the teletype base (stand). This eliminates the mounting, unmounting, and repacking of the power pack previously required.

2) The 3300 series punch mechanism is always equipped for automatic operation (DC2 and DC4 control) but automatic operation is inhibited by a pair of clips installed at teletype. See teletype manual for details.

3) The 3300 printer mechanism is equipped with mechanism to provide the CR LF function when CR is received but this feature is inhibited by a clip installed at teletype. See teletype manual for details. This feature did not exist on DEC purchased 33 series units.

4) The answerback mechanism (and any other stunt box feature requiring disabling) is disabled (when specified by the DEC construction drawings) by means of an inhibit clip on the 3300. On 33 series units the answerback mechanism was disabled by removing the stunt box pawl associated with it. The 3300 clip can also be used on 33 series units.

5) The 3300 keyboard is equipped to generate even character parity but can be arranged to generate eighth-bit-marking code by swapping quick connect tabs. A 33 series unit either did or did not have a parity keyboard and changing a parity keyboard to non-parity operation required disassembly and modification of contact bars on the keyboard.

NOTE A: 33 series units evolved over the years and details of parts replacement and subtleties of operation varied even for the same model number. Do not construe the above list of differences as implying that all DEC purchased 33 series machines of a particular model number were the same over their entire lifetime.

NOTE B: A complete programming and operating description of all DEC supplied 33 Teletypes (after the PDP-6 and classic LINK) is contained in DEC specification A-SP-LT33-#-14 "LT33 Programming Specification" available from reproduction.

Title DIFFERENCES BETWEEN NEW 3300 SERIES TELETYPE AND OLD 33 TS, TU, TBP (Cont.)				Tech Tip Number LT33-TT-10	
All Processor Applicability				Author Ray Alvarez Rev g	
X				Approval Dick Russell Date 6/25/74	
				Cross Reference	

1) Keyboard Differences:

The keyboard key which generates 136_g will be labelled "A".
It is presently labelled "↑".

2) The keyboard key which generates 137_g will be labelled " _"
(underscore). It is presently labelled "←".

3) The printer mechanism will print "A" when it receives 136_g.
It presently prints "↑".

4) The printer mechanism will print " _" (underscore) when it receives
137_g. It presently prints "←".

5) The printer mechanism will print "N", "J", and "A" when it receives
174_g, 175_g, and 176_g respectively. Presently it prints nothing when
receiving these codes. NB: 174_g was formerly ACK, 175_g was formerly
ALT MODE, and 176_g was formerly ESC₁.

6) The keyboard will have a key labelled ESC which will generate the
code 033_g. There will be no key labelled ALT MODE and no way to generate
the codes 175_g or 176_g from the keyboard.

7) The keyboard key which generates 177_g will be labelled DELETE.
It is presently labelled RUB OUT.

8) These changes are already reflected on the pocket reference card
for 8's and 11's.

9) All machines except the LT33-D type machines will generate even
parity from the keyboard. At present some other LT33 units have
the 8th (parity) bit always "1". It is planned that eventually all
machines will generate even parity from the keyboard.

The ALT MODE/ESC change should not affect any properly written program.
That is, DEC has in the past shipped model 33 Teletypes which have had
either ALT MODE keys (175_g), ESC₁ keys (176_g) or ESC₂ keys (033_g). In
addition, non-DEC terminals are variously designed to use 175_g or 033_g
as ALT MODE/ESC and if not in a "lower case" mode should also accept
175_g and 176_g. (On lower case machines 175_g is "J" and 176_g is "N").
In addition, ALT MODE/ESC should not be "echoed" by the program unless
it is intended to perform some particular function for some particular
terminal (e.g. on some model 37 Teletypes the sequence "ESC 3" shifts
the machine into red ribbon mode).

It is recommended that user programs which use "↑" as a command operator
(e.g., to direct a data transfer to one file from another) should be
modified to accept "=" for this function as well as "←" since the left
arrow will become underscore (" _").

It is believed that the symbols "↑" and "A" are sufficiently similar
that no program change involving them is needed.

digital	FIELD SERVICE TECHNICAL MANUAL				CPT Option or Designator
	12 Bit <input checked="" type="checkbox"/>	16 Bit <input checked="" type="checkbox"/>	18 Bit <input checked="" type="checkbox"/>	36 Bit <input checked="" type="checkbox"/>	LT33 to LT35

Title DIFFERENCES BETWEEN NEW 3300 SERIES TELETYPE AND OLD 33 TS, TU, TBP (Cont.)				Tech Tip Number LT33-TT-10	
All Processor Applicability				Author Ray Alvarez Rev #	
X				Approval Dick Russell Date 6/25/74	
				Cross Reference	

Unrelated to the above described changes, the following programming practices are recommended in dealing with teletypewriter-like devices to ensure compatibility with the largest number of terminals.

1. A program unwilling to deal with lower case input should translate codes 140_g to 173_g to the corresponding upper case codes 100_g thru 133_g.
2. The eighth bit of each character (the 200_g bit) should be ignored when received in general purpose programs. This bit is commonly even parity or a "1" but in some terminals can be odd parity or a "0".
3. The eighth bit of each character (the 200_g bit) should be transmitted as even parity. This will not confuse 33's or 35's and is necessary on some other terminals.
4. Control characters should not be echoed when some particular action is expected from the teleprinter (e.g. control back slash, "FS" causes the cursor to be returned to the upper left hand corner of the screen on the VT#5 and VT#6).

In order to verify that software is not sensitive to the eighth bit ("parity bit") from Teletype it is useful to modify selected Teletypes so that keyboard characters always have their 8th bit spacing ("0") instead of the more usual marking ("1") 8th bit. The simple procedure is detailed on the attached sketch. Machines which are modified should be prominently marked "Modified: Keyboard 8th bit zero."

Diagnostics such as PDP8E Teletype and KL8E Asynchronous Data Control Tests, are compatible except with one noted difference. On transmit from CPU to TTY, a 7-hole rub out will appear as "↑" an up arrow. This is due to new 3300 series printers having one less function lever (slot 5) if customer so desires full compatibility he may order function lever #180-793 and have it installed at per call rates.

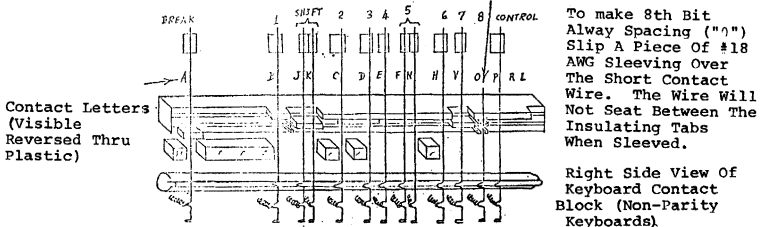

PAGE 407	PAGE REVISION 0	PUBLICATION DATE July 1974
----------	-----------------	----------------------------

Title ASR 35 READER FAILURES						Tech Tip Number LT35-TT-1		
All	Processor Applicability					Author Tom Bowman	Rev 0	Cross Reference
						Approval W. Cummins	Date 7-31-72	

Intermittent reader problems have resulted from a loosening of the sponge rubber pad which is mounted to the cover plate above the reader pins. Contact cement should be used to secure this pad as is now being done in production.

Title PRICING POLICY FOR TELETYPE CONVERSIONS						Tech Tip Number LT35-TT-2		
All	Processor Applicability					Author	Rev 0	Cross Reference
	X					Approval W. Cummins	Date 8/17/72	

This Tech Tip is issued for cross reference purposes only.

Title KSR-35 LUBRICATION						Tech Tip Number LT35-TT-3		
All	Processor Applicability					Author M. Schwartz	Rev 0	Cross Reference
	X					Approval Lou Nay	Date 02/15/73	

The present PM procedure for KSR-35 Teletypes calls for lubrication on a quarterly basis. However, at most sites the console teletype runs 24 hours a day. The heat generated and centrifugal force will dissipate the lubricants within the clutch bearings, drums and shoes in less than 30 days.

Under the above operating conditions, monthly lubrication should be made - at least in the mainshaft area.

COMPANY CONFIDENTIAL

PAGE 408	PAGE REVISION A	PUBLICATION DATE 197
----------	-----------------	----------------------

digital	FIELD SERVICE TECHNICAL MANUAL				Option or Designator M220
	12 Bit <input checked="" type="checkbox"/>	16 Bit <input type="checkbox"/>	18 Bit <input type="checkbox"/>	36 Bit <input type="checkbox"/>	to M302

Title M220 REVISION C				Tech Tip Number M220-TT-1	
All Processor Applicability			Author B. Nunley	Rev 0	Cross Reference
8I	8L		Approval W. Cummins	Date 7-31-72	8I & 8L

Some intermittent M220 problems, noted to date, were due to overloading rather than failure of adder input gates. ECO M220-00003, which has been issued to eliminate this overloading, adds the following jumpers to the M220 module:

Revision A board:

- Pin 8 of E12 to Pin 8 of E13
- Pin 8 of E14 to Pin 8 of E18

Revision B board:

- Pin 8 of E16 to Pin 8 of E14
- Pin 8 of E12 to Pin 8 of E15

~~_____~~ OBSOLETE
~~_____~~ TECH TIP
~~_____~~ MCW
~~_____~~ ECO M220-00003

TAKEN
 SUPPLEMENTAL ACTION

M220-Revision C will have this ECO installed. Revision B of the ECO is not necessary to bring down an operating system to install the ECO; it should be installed when any M220 is worked on or suspected to be a problem.

Title M220 MODULES IN 680-I and DL8I				Tech Tip Number M220-TT-2	
All Processor Applicability			Author W. Cummins	Rev 0	Cross Reference
8I			Approval W. Cummins	Date	PDP-8I

The M220 modules used in a 680-1 must be revision "B" or later. The "B" revision adds an interrupt and changes a gate used as a "local AND" for TT-Line Shift. Therefore, revision "A" cannot be used in a DL8I.

COMPANY CONFIDENTIAL

Title RINGING ON M302 OUTPUT						Tech Tip Number M302-TT-1	
All Processor Applicability			Author Sweeney/MacLeod		Rev 0		Cross Reference
8's			Approval F. Purcell		Date 11/20/72		

The M302 revision K and L will have multiple transitions on the trailing edge of the output, when the input trigger signal remains low longer than the delay time-out. (When a pulse trigger signal is used, this problem does not occur.)

This particular problem showed up in the TR05 Magtape Interface. The signal RAMP H was causing inconsistent tape motion. Replacement of the M302 at location A18 of the TR05 with a new M3020 will correct this deficiency. If an M3020 is not available, an M302 with a revision earlier than K may be substituted.

COMPANY CONFIDENTIAL

PAGE 410	PAGE REVISION 0	PUBLICATION DATE November 1972
----------	-----------------	--------------------------------

digital	FIELD SERVICE TECHNICAL MANUAL				Option or Designator
	12 Bit <input type="checkbox"/>	16 Bit <input checked="" type="checkbox"/>	18 Bit <input type="checkbox"/>	36 Bit <input checked="" type="checkbox"/>	M307

Title M307 JUMPER CONFIGURATION					Tech Tip Number M307 TT# 1	
All	Processor Applicability			Author Newbury/Meyer	Rev 0	Cross Reference
X				Approval W. Cummins	Date 7-31-72	

Revision A of the M307 requires jumpers to determine the range. Revision B replaces the external connections with a switch. Below is a table of equivalent jumper connections and switch position:

<u>Equivalent Jmp Connections</u>			
<u>Switch Position</u>	<u>S1 for IOS1</u>	<u>S2 for IOS2</u>	<u>Time</u>
5	D2 to D1	M2 to U2	5 - 50 u sec
4	D2 to B1	M2 to V2	50 - 500 u sec
3	D2 to E1	M2 to S2	500 u - 5m sec
2	D2 to F1	M2 to R2	5m sec - 50m sec
1	D2 to H1	M2 to P2	50 m sec - 500m sec

On the revision B board no provision is made for the addition of external capacitance. On revision A boards external capacitance may be added from Pin D2 to J1 for IOS1. From M2 to N2 for IOS2. The positive lead should be pin D2 to IOS1 and N2 to IOS2. Internal Pot connection for IOS1 are pins C2 to A1 and for IOS2 pins P1 to V1. These connections are true for both revisions.

Title M307 INSTABILITY					Tech Tip Number M307-TT-2	
All	Processor Applicability			Author	Rev 0	Cross Reference
X				Approval H. Long	Date Aug 1972	TU56-TT-7

COMPANY CONFIDENTIAL

-- NOTES --

digital	FIELD SERVICE TECHNICAL MANUAL				Option or Designator
	12 Bit <input checked="" type="checkbox"/>	16 Bit <input checked="" type="checkbox"/>	18 Bit <input type="checkbox"/>	36 Bit <input checked="" type="checkbox"/>	M405

Title M405 A CRYSTAL CLOCK-MULTIPLE OUTPUT				Tech Tip Number M405-TT-1	
All Processor Applicability		Author GUS PASQUANTONIO		Rev 0	
8's 15		Approval DICK EDWARDS		Date 11/20/72	
				Cross Reference	

The M405A Crystal clock has been known to produce a multiple pulse output when operating in the 5-10 and 19-20 KHZ ranges. If you experience this problem, replace M405A with M405B, which incorporates ECO M405-01. This ECO isolates the analog circuitry ground from the tank circuitry ground, and both widens and shortens the tank ground path to reduce inductance, thereby eliminating the problem.

If an M405B is not available you may install the ECO yourself as follows: Looking at the etch side of the M405A (Handle **WP**), cut the etch between the bottom left shield screw and R5. Solder a piece of insulated wire from Pin 7 of E1 to the ground side of R1.

The accompanying sketch illustrates the ground path and the alteration points.

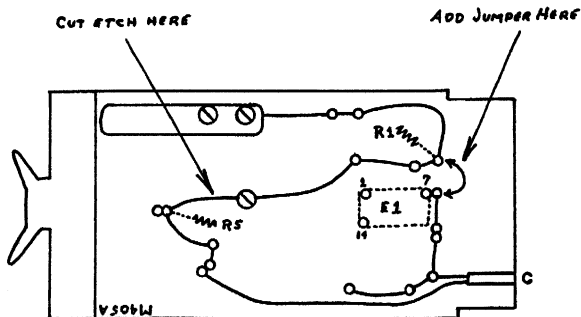

Title SELECTION OF COMPONENTS FOR USE WITH CRYSTALS						Tech Tip Number M405-TT-2	
Processor Applicability						Author Ralph Boehm Rev 0	
All						Cross Reference	
X						Approval Chuck Sweeney Date 9/18/74	

On the M405 and R405 Module there may be a need to know what inductor and capacitor to use with a crystal to obtain a certain frequency. The following table may be of some use to determine the correct values.

Crystal Frequency (F)	Inductor (L) Value & P/N	Approx Value Of Capacitor (C)
5 to 10 KHz	470 mh 16-00638	2000 to 400 μ f
10 to 25 KHz	220 mh 16-00637	1100 to 200 μ f
25 to 40 KHz	100 mh 16-00632	400 to 150 μ f
40 to 100 KHz	4.7 mh 16-00639	2500 to 500 μ f
100 to 250 KHz	1000 μ h 16-00636	2000 to 400 μ f
250 to 500 KHz	220 μ h 16-00634	1800 to 450 μ f
.5 to 1MHz	47 μ h 16-00626	2500 to 400 μ f
1 to 2.5 MHz	10 μ h 16-00624	2500 to 400 μ f
2.5 to 10 MHz	3.3 μ h 16-00620	1300 to 75 μ f

* Capacitor values can be determined by the formula $C = \frac{1}{40F^2 L}$;

e.g. Crystal frequency = 2.88 MHz - The table above says to use a 3.3 μ h inductor.

$$C = \frac{1}{40(2.88 \times 10^6)^2 \times 3.3 \times 10^{-6}} = 913 \mu\text{f}$$

Use the closest available size mica capacitor available such as P/N 10-2344 (1000 μ f)

If closer tolerance is needed, then use a trimmer capacitor that may be purchased locally.

digital	FIELD SERVICE TECHNICAL MANUAL				Option or Designator
	12 Bit <input checked="" type="checkbox"/>	16 Bit <input type="checkbox"/>	18 Bit <input type="checkbox"/>	36 Bit <input type="checkbox"/>	M410 to M848

Title M410 REED CLOCK				Tech Tip Number M410-TT-1		
All	Processor Applicability			Author Bill Freeman	Rev 0	Cross Reference
	8I			Approval Bill Cummins	Date 7-31-72	

A problem has been encountered with the reed in the M410 reed clock. The error indication may be that the DC08A clock interrupts stop, causing the user program to hang up. The problem may be that the bracket is not properly supporting the reed. The solution is to put double sided tape on the bracket so that it holds the bracket to the top of the reed and the reed is seated properly in its holder. It may be necessary to elongate the mounting hole on the support bracket to permit a firm bond between the bracket, the tape and the reed.

Title SPEED SELECTION OF M453 CLOCK				Tech Tip Number M453-TT-1		
All	Processor Applicability			Author Bill Freeman	Rev 0	Cross Reference
	8I			Approval W. Cummins	Date 7/31/72	

When using an M453 variable speed clock in place of an M452 clock in a DC02A, the following jumpers are used to determine the frequency of the clock output.

Frequency	Baud rate	Pins Used On Clock
200 hz - 1K hz	25 baud - 125 baud	J1-R1
1K hz - 5K hz	125 - 625	J1-P1
5K hz - 25K hz	625 - 3125	J1-N1
25K hz - 125K hz	3125 - 15625	J1-M1
125K hz - 625K hz	15625 - 78125	J1-L1
Greater than 625K hz	greater than 78125	J1-K1

If an M453 is to be installed instead of an M452 also add S1 to U1 and V1 to +5 on each clock.

COMPANY CONFIDENTIAL

Title						POWER FAIL OPTION (M848)						Tech Tip						Number M848-TT-1							
All		Processor Applicability						Author			Ralph Boehm			Rev			0			Cross Reference					
8M		8E						Approval			W. Cummins			Date			07/31/72								

Due to the difference in power supplies between the 8E and the 8M, the M848 module must be brought up to Revision "K" to work correctly. Revision "J" installs split lugs on the M848, for use in an 8/M remove the jumper in these split lugs. For use in an 8/E install a jumper.

"8/M jumper out - 8/E jumper in"

COMPANY CONFIDENTIAL

PAGE	416	PAGE REVISION	0	PUBLICATION DATE	July 1972
------	-----	---------------	---	------------------	-----------

digital	FIELD SERVICE TECHNICAL MANUAL				Option or Designator
	12 Bit <input checked="" type="checkbox"/>	16 Bit <input type="checkbox"/>	18 Bit <input type="checkbox"/>	36 Bit <input type="checkbox"/>	M868

Title TDSE Dectape Option				Tech Tip Number TT#1	
All Processor Applicability			Author Ray Alvarez	Rev 0	Cross Reference
8E			Approval Frank Purcell	Date 2/1/74	

PROBLEM:

An unexplainable intermittent data errors occur when transferring successive blocks of data from one tape unit to another or to another peripheral. This change should only be implemented if symptoms appear and are not due to other likely causes.

SOLUTION:

Tie floating inputs pin 4&6 on nand gate E40 to output pin 2 on and gate Gate E38

BEFORE

AFTER

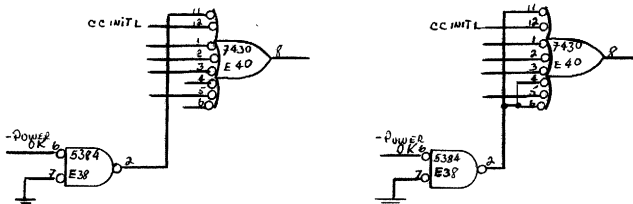

Title M8310 MANUFACTURING DEFECT				Tech Tip Number M8310-TT-1		
All	Processor Applicability			Author Peter Jones	Rev 0	Cross Reference
	8E			Approval W. Cummins	Date 03/08/73	

M8310's CS Rev. F, Etch Rev. F have been known to have a manufacturing defect with the etch on Side #2 between E53 pin #13 and E28 pin #2 near C12. This is the Direct Clear Signal for the Skip Flip-Flop. The failure symptom is a halt at location 0153 of Instruction Test #1. MAINDEC-8/E D#AB (05/10/71).

/mt

Title WIRE PLACEMENT ERROR, ECO M8330-003				Tech Tip Number M8330-TT#1		
All	Processor Applicability			Author Len Turner	Rev #	Cross Reference
	8E	8M	8F	Approval J. Blundell	Date 1/9/74	

Some M8330 boards have been seen to fail in heavily loaded systems although they exhibit no problems when tested in a smaller system or the XOR tester used by production and the repair depot.

The failures are caused by the wire added by ECO#3 (EAE clock) interfering with the crystal oscillator if it passes near the capacitors in the oscillator circuit. Next call check this run and change it if necessary.

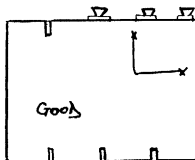
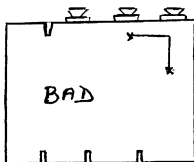

Run wire horizontally to E15, then vertically up to the feedthrough that is row used.

digital	FIELD SERVICE TECHNICAL MANUAL				Option or Designator
	12 Bit <input checked="" type="checkbox"/>	16 Bit <input type="checkbox"/>	18 Bit <input type="checkbox"/>	36 Bit <input type="checkbox"/>	M8350 to M18F

Title ADJUSTMENT OF M8350 POSITIVE I/O MODULE				Tech Tip Number M8350-TT-1		
All	Processor Applicability			Author Don Herbener	Rev 0	Cross Reference
	BE	8M	8F	Approval Frank Purcell	Date 01/23/73	

Many M8350 modules being returned as defective are just out of adjustment. To adjust the module put in the following program where XX is a non-existent device code.

7000 - 6XX7
7001 - 5200
7002 - 5200

Now look at IOP 1 with probe 1 and IOP 2 with probe 2 at the most distant interface logic. The width of IOP 1 should be adjusted between 600 and 800 nanoseconds and the separation should be adjusted between 200 and 400 nanoseconds. The specification for total time from the start of IOP 1 to the start of IOP 2 should be between 800 nanoseconds and 1 microsecond.

Title DATA BREAK PRIORITY JUMPERS				Tech Tip Number M8360-TT-1		
All	Processor Applicability			Author R. Shelley	Rev 0	Cross Reference
	8E	8M	8F	Approval J. Blundell	Date 4-1-74	

Title WIRING ERROR NC8I				Tech Tip Number NC8I-TT-1		
All	Processor Applicability			Author R. Nunley	Rev 0	Cross Reference
	<input checked="" type="checkbox"/>	K		Approval W. Cummins	Date 7/31/72	

There is possibly a wiring error in some 8I logic serial numbers 1400 to 2500. The effects are so random in failure rate and symptoms that situations may arise where either software errors or hardware intermittence may be blamed. An occasional illegal skip on a non-skip IOT, intermittent going to the wrong field, bad data from or wrong location addressed in MM8I, are among the symptoms. The error will not show up using Maindecs. The error is RMF is tied to +3V (16) which is clamp voltage for MA bits 6 through 8 to the MM.

To check for the error being present look for a jumper between B15V1 and B06E1. If that jumper is there, remove it.

COMPANY CONFIDENTIAL

Title <i>MISE Manual</i>						Tech Tip Number <i>MISE-TT-1</i>		
All	Processor Applicability					Author <i>W. Freeman</i>	Rev <i>0</i>	Cross Reference
	<i>8F</i>	<i>8E</i>				Approval <i>W. Cummins</i>	Date <i>06/21/72</i>	

The preliminary *MISE Manual*, Page 3, explains the encoding scheme of options. The discussion for the *TD8E* is in error. The data should be:

1312
4312
4312
6773

.

.

.

Title <i>MISE RESTRICTION FOR TYPESET BOOTSTRAP</i>						Tech Tip Number <i>MISE-TT-2</i>		
All	Processor Applicability					Author <i>Fred Jewell</i>	Rev <i>0</i>	Cross Reference
	<i>8E</i>	<i>8M</i>				Approval <i>Fred Miller</i>	Date <i>02/27/73</i>	

The *MISE* is a 32 word ROM, used typically to load a bootstrap into core memory by duplicating the actions of the console switches (S.R., load address, deposit, etc.)

It was not designed to load less than 32 words into core, and so the short bootstrap such as the typesetting rim loader have to be lengthened to 32 words by filling unused locations with zeros.

This can raise a problem when you wish to use a binary dump program to dump data contained in the area loaded with zeros by the bootstrap and you load the dump program the easy way by using the SW switch to run the ROM (and so zeroing out part of the data.)

The correct procedure to avoid this problem is to load address 7770 (for Typesetting RIM) and start manually if RIM is in core, or, if not, then toggle RIM in manually and then start.

PDP8 Engineering has been made aware of the problem and will decide whether it is economically worth while to add jumpers to theboard to allow loading of shorter blocks than 32 words.

/mt

COMPANY CONFIDENTIAL

PAGE 420	PAGE REVISION A	PUBLICATION DATE February 1973
----------	-----------------	--------------------------------

digital	FIELD SERVICE TECHNICAL MANUAL				Option or Designator
	12 Bit <input checked="" type="checkbox"/>	16 Bit <input checked="" type="checkbox"/>	18 Bit <input checked="" type="checkbox"/>	36 Bit <input checked="" type="checkbox"/>	M18E to MM8EJ

Title					Tech Tip	
M18E BOOTSTRAP LOADER IDIOSYNCRASIES					Number M18E-TT-3	
Processor Applicability			Author Allen Moll		Rev \emptyset	
All	8e	8m	8f	Approval Jeff Blundell		Date 3 May 73
					Cross Reference	

Customers purchasing an uncoded M18E with the intention of encoding it to bootstrap a system device should be made aware that the M847 bootstrap logic's first action upon being started is to pulse to ground the power OK H line on the omnibus (Pin BV2).

Some intelligent mechanical devices such as the RK05 may see this as an indication that A.C. power is about to go away, and begin a power down sequence, resulting in a "Not Ready" condition for several seconds.

During this time, the bootstrap has finished loading core, and has started the loader running. The loader will typically hang on a flag, because the device was not ready.

The simplest way around this is to precede the bootstrap program with a long IS~~E~~ loop, to allow the effects of the pseudo power OK "not OK" to go away, or better still, look at the devices status register to see when it becomes ready. (This is the way in which the recently released M18-EJ RK05 bootstrap works).

Title MM8EJ MODULE INTERCHANGEABILITY						Tech Tip Number MM8EJ-TT-1		
All	Processor Applicability					Author Bruce Tarpley	Rev \emptyset	Cross Reference
	8E	8M				Approval Frank Burcell	Date 12/1/72	

There are two combinations of boards which have been shipped to date. Up until September 15, 1972 G111 Rev. D., G646 Rev. B., and G233 Rev. E were shipped. Everything up to serial #230 falls into this group. The serial number is stamped in ink on each memory board.

Since 9/15/72, G111 Rev. F., G646 Rev. C., and G233 Rev. F have been shipped. This is the correct and most up-to-date combination.

Any problem encountered with an MM8EJ with a serial number below 230 should be treated by removing the entire memory and returning it for repair. The G111 and G646 may be retrofitted, but the G233 should be scrapped.

Any MM8EJ with serial number greater than 230 has modules which are totally interchangeable and may be replaced singularly if necessary.

If a D or E Rev G111 must be retrofitted to an F Rev in the field, the following procedure must be followed:

Use a G233 which has both a 14.7K and 34.8K resistor in it.
(R96 and R97)

With a Digital Voltmeter, measure the voltage on pin HAL, V_{xy} , and the +5 volts. V_{xy} must be between -3.65 and -3.70 with respect to the +5 volt measurement. To change V_{xy} , a parallel resistor should be put across R65.

Below is a list of useful resistor values which may be used for R65.

<u>Value</u>	<u>Pin #</u>
2.37K	13-10632 $\frac{1}{2}$ watt, 1%
2.49K	13-00424 $\frac{1}{2}$ watt, 1%
2.61K	13-03303 $\frac{1}{2}$ watt, 1%
2.74K	13-04868 $\frac{1}{2}$ watt, 1%

To change from 2.37K to 2.74K gives a voltage change in V_{xy} of approximately 130 mv. If R65 is made larger, V_{xy} becomes smaller.

COMPANY CONFIDENTIAL

digital	FIELD SERVICE TECHNICAL MANUAL				Option or Designator
	12 Bit <input checked="" type="checkbox"/>	16 Bit <input type="checkbox"/>	18 Bit <input type="checkbox"/>	36 Bit <input type="checkbox"/>	MM14A

Title POWER SUPPLY REPLACEMENT FOR MM14A				Tech Tip Number MM14A-TT-1		
All	Processor Applicability			Author Larry Goelz	Rev g	Cross Reference
	14			Approval G. Chaisson	Date 01/24/73	

If the power supply in the MM14A requires replacing, it is important that the components mounted around the convenience outlet be removed. These components are not a part of the H716 (armour) power supply. The components to be removed are:

1. One transformer - FX25
2. One capacitor - ~~44~~ μ fd
3. One resistor - 22K
4. Two diodes - ~~4~~ β 4

It is suggested that the old supply be removed when the replacement is on hand.

Title M741C REVISION FOR OPERATION WITH MM14A				Tech Tip Number MM14A-TT-2		
All	Processor Applicability			Author L. Goelz	Rev g	Cross Reference
	14			Approval G. Chaisson	Date 7/30/73	

The M741 must be a revision "D" in order to operate the MM14A properly. If a Revision "D" is not available perform the following steps to convert a M741 Rev. "C" to Rev. "D".

Reference: Figure 1 and 2
Parts List: Table 1

- 1) Remove IC E14, DEC 7400, from the M741
- 2) Cut the etch from the following pins "Ref. Fig. 1 & 2"
 - a) E14 Pins 3, 11 and 12
 - b) E14 pin 2 to E16 pin 11 *
 - c) BP1 to E14 Pin 4 and E17 pin 3
- 3) Install a DEC 7410 into E14
- 4) Connect the following pins Ref. to fig. 1
 - a) E14 Pin 12 to E8 Pin 5
 - b) E14 Pin 2 to E8 Pin 3
 - c) E14 Pin 3 to Pin BP1

COMPANY CONFIDENTIAL

Title						Tech Tip	
M741C REVISION FOR OPERATION WITH MM14A						Number MM14A-TT-2	
Processor Applicability			Author		Rev		Cross Reference
All			L. Goetz		β		
14			Approval		Date		
			G. Chaisson		7/30/73		

- d) Pin Bp1 to 1K resistor other end to +5 volt side of R33
- e) E14 pin 10 to E14 pin 11
- f) E17 pin 10 to E13 pin 1
- g) E17 pin 8 to E17 pin 9
- h) E17 pin 8 to E16 pin 11

* E14 pin 1 and pin 2 are jumpered leave jumper in stalled.

Part List

1K	$\frac{3}{4}$ WATT	13-00365
DEC	7410	19-25576

Table 1

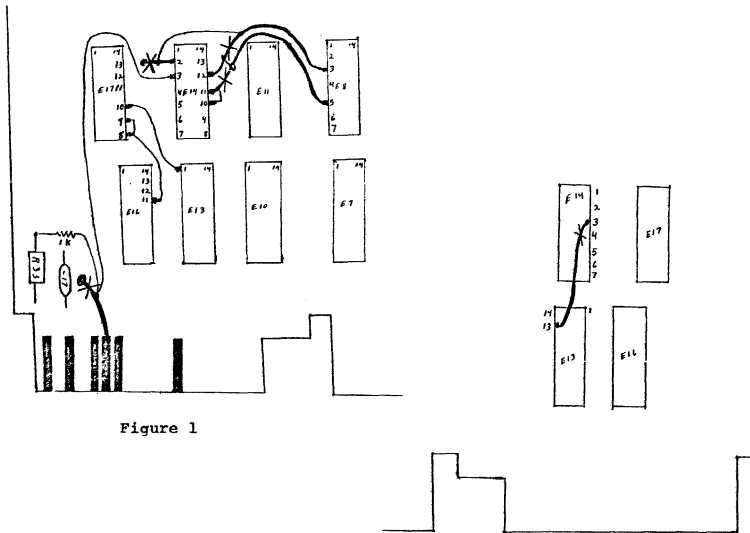

Figure 1

FIGURE #2

digital	FIELD SERVICE TECHNICAL MANUAL				Option or Designator
	12 Bit <input checked="" type="checkbox"/>	16 Bit <input type="checkbox"/>	18 Bit <input type="checkbox"/>	36 Bit <input type="checkbox"/>	MM14A to M18E

Title Installation of MM14A in PDP14 without DL14 Option				Tech Tip Number MM14A-TT-3	
All Processor Applicability				Author Fred Silva Rev 0	
14				Approval Don Herbener Date 16 May74	
				Cross Reference	

When installing an MM14A (ECO 14-0054) in a PDP-14 without DL14 wiring, make the following wiring additions in place of those listed in that ECO.
NOTE: ALL WIRING CHANGES ARE ADDITIONS.

ADDITIONS

<u>Signal Name</u>	<u>From Pin</u>	<u>To Pin</u>
Mem GO mem	B02L1	A01L2
Initialize L	B02P1	B16R1
HD T pulse	D02N1	B23P1
EM H	B02C1	B18V2
IR11 (1) H	B02B1	B23S2
Mem done L	B02K1	A23E2
LD MB L	D02J1	B24J1
PC1 00 (1) H	D02P1	C19E2
PC1 01 (1) H	D02H1	C19H2
PC1 02 (1) H	D02R1	B01K2
PC1 03 (1) H	D02F1	B04F2
PC1 04 (1) H	D02V1	A04R2
PC1 05 (1) H	D02D1	A04S2
PC1 06 (1) H	D02U1	B04D2
PC1 07 (1) H	D02E1	B04E2
PC1 08 (1) H	D02M1	B04M2
PC1 09 (1) H	D02A1	B04A1
PC1 10 (1) H	D02L1	B04G1
PC1 11 (1) H	D02B1	B04R1
MB 00 (1) H	C02L1	C18E2
MB 01 (1) H	C02K2	C18H2
MB 02 (1) H	C02L2	C18K2
MB 02 (1) H	C02K1	C18M2
MB 04 (1) H	C02R1	C18P2
MB 05 (1) H	C02D2	C18S2
MB 06 (1) H	C02S1	D18E2
MB 07 (1) H	C02E2	D18H2
MB 08 (1) H	C02F1	D18K2
MB 09 (1) H	C02B1	D18M2
MB 10 (1) H	C02P2	D18P2
MB 11 (1) H	C02A1	D18S2
MBS 00 L	C02M2	A04E1
MBS 01 L	C02J1	A04J1
MBS 02 L	C02M1	B04H1
MBS 03 L	C02J2	B04F1
MBS 04 L	C02P1	A04R1
MBS 05 L	C02E1	A04S1
MBS 06 L	C02N1	B04D1
MBS 07 L	C02D1	B04M1
MBS 08 L	C02H2	B04K1
MBS 09 L	C02C1	B04L1
MBS 10 L	C02H1	A04F1
MBS 11 L	C02B2	A04K1
Enable Mem L	B02U1	D04C2
GND 1	A02T1	A17T1
GND 2	B02C2	B17C2
GND 3	B02T1	B17T1
GND 4	C02C2	C17C2
GND 5	C02T1	C17T1
GND 6	D02C2	D17C2

Title PDP-12 MEMORY BUS TERMINATION						Tech Tip Number MM8I-TT-1		
All <input checked="" type="checkbox"/>	Processor Applicability					Author H. Long	Rev 0	Cross Reference
						Approval H. Long	Date 6/2/72	

Dwg. A-MU-MM8I-A specifies that a G717 terminator is to be used at the physical end of the memory bus. The PDP-12 memory bus drivers are severely loaded by a G717 and memory problems may occur. Instead, use a M906 terminator in A32 or D32 as necessary. NOTE: The M906 requires a +5 volt supply; jumper +5V to A32A2 or D32A2 as necessary.

Title Noise In MM8I						Tech Tip Number MM8I-TT-2		
All <input checked="" type="checkbox"/>	Processor Applicability					Author R. Nunley	Rev B	Cross Reference
						Approval W. Cummins	Date 7/31/72	

We are getting complaints of erratic operation of MM's on systems 12K and up. The symptoms are inability to run EAE maindecs in field 2 and up or occasional jumping to wrong field for data or instructions, or inability to manual load or examine in field 2 and up, etc.

The problem is noise pick-up in the MM due to proximity of mem done and mem start, and between EA bit signal lines, and in some cases, poor termination.

The following is a summary of cures for the problem:

- ECO8I-00054 - Buffer mem start and TP2. Install in all with MM.
- ECO 8I-00085 - Delay TP3 by 50 nanosec to allow adder more set-up time. Install in all with MC.
- ECO 8I-00107 - Buffers EA bits and increases drive capability. Install in all with MM where noisy EA bits are observed.
- ECOMM8I-00015 - Inhibits mem done from a nonexistent field in MM8IA or MM8IC. Install in all MM8IA or MM8IC. ECOMM8IA-00016 corrects ECOMM8IA-00015. (Last line should read B08E1 to B06B1 - add, instead of B06B1 to B06E1 - add.)
- ECOMM8I-00012 - Terminates mem start and TP2 in last MM. Install in last MM.

The cure for inductive pick up between mem start and mem done is to reroute and separate the two by maintaining the current pin connections but reroute mem start across the "A" row and mem done across the "D" row, instead of both running across the "B" row. The same type thing could be done for the EA lines if inductive noise is observed on them in the MM.

PAGE 426	PAGE REVISION A	PUBLICATION DATE February 1973
----------	-----------------	--------------------------------

COMPANY CONFIDENTIAL

digital	FIELD SERVICE TECHNICAL MANUAL				Option or Designator
	12 Bit <input checked="" type="checkbox"/>	16 Bit <input type="checkbox"/>	18 Bit <input type="checkbox"/>	36 Bit <input type="checkbox"/>	MM8I

Title MM8I 4/k-8/K Conversion				Tech Tip Number MM8I-TT-3	
All x	Processor Applicability			Author J. Blundell	Rev A
				Approval W. Cummins	Date 2/6/73
					Cross Reference

An MM8I-A is the MM logic with only 4K installed. ECO MM8I-00013 prevents the generation of memory done from the non-existent field in an MM8I-A. The MM8I is wired initially as an MM8I-B (8K). To make it operate properly as an MM8I (4K), wiring should be done after ECO MM8I-00013 has been installed.

DELETE: B08E1 to B06B1 - ADD: B06S1 to B06B1
 To revert
 to 8K: DELETE: B06S1 to B06B1 - ADD: B08E1 to B06B1

These wiring changes are shown in the ECO drawing but not in the ADD/DELETE list.

Title MM8I Memory Field Conversion						Tech Tip Number MM8I-TT-4		
All X	Processor Applicability					Author Len Pollicove	Rev B	Cross Reference
						Approval R. Nunley	Date 6/26/73	

1. ECO level of 8I and MM effect the necessary wiring when adding MM as extended 2 (field 4 & 5) or as extended 3 (field 6 & 7). The effecting ECO's are 8I-024, 8I-026 and MM8I-06.

Signal Location:

Before ECO's

EA0 (1) A28 or D28 D2
EA1 (1) A28 or D28 E2
EA2 (1) A28 or D28 H2

After ECO's

EA0 (1) A30 or D30 D2
EA1 (1) A30 or D30 E2
EA2 (1) A30 or D30 H2

2. MM8I Memory Field Conversion:

For add-on MM8I extend 2 or extend 3, check notes on print MM8I-A. All extended memories will be wired as extended 1-control fields 2+3. To convert from extend 1 to extend 2 - control field 4+5.

EA0 (0) B07L1 to B07K2-delete
EA1 (1) B07M1 delete
EA0 (1) to B07H2 delete
EA0 (1) to B07L1 add
EA1 (1) to B07H2 add
EA1 (0) B07K2 to B07M1 add

To convert from extend 1 to extend 3
control fields 6+7

EA0 (0) B07L1 to B07K2 delete
EA0 (1) B07H2 delete
EA0 (1) to B07L1 add

Handwritten notes:
B07L1
B07H2
B07M1
B07K2
EXTEND 2
EXTEND 3

Page 2

COMPANY CONFIDENTIAL

Title PRINT CORRECTIONS (PDP-12)						Tech Tip Number MM8I-TT-5		
All X	Processor Applicability					Author	Rev 0	Cross Reference
						Approval H. Long	Date 08.17.72	

The following signal names should be corrected on the MM8I-A-1, Memory Control Page.

Name	To
1. MEM START	MXB START MEM H
2. BTP2	MXB MEM TP 3 H
3. EAO	MXF EA Ø H
4. EAL	MXF EA 1 H

/mt

PAGE 428	PAGE REVISION 0	PUBLICATION DATE August 1972
----------	-----------------	------------------------------

digital	FIELD SERVICE TECHNICAL MANUAL				Option or Designator
	12 Bit <input checked="" type="checkbox"/>	16 Bit <input checked="" type="checkbox"/>	18 Bit <input checked="" type="checkbox"/>	36 Bit <input checked="" type="checkbox"/>	MODULE OPTION TO MOS DEVICES

Title ORDERING SINGLE MODULE OPTIONS				Tech Tip Number MOD-TT-1		
All	Processor Applicability			Author Al Sliz	Rev 0	Cross Reference
	8	11	15	12	Approval Don Herbener	

The following list of modules may be referenced by two different means. Either as a module (such as A124) or as an option (such as BA150).

When ordering replacements, use the standard module designations. When ordering Add-On options or initial orders use the option designation (which designation plus a "B" prefix).

(B) A124	(B) K022	(B) M681	(B) W400
(B) A125	(B) K272	(B) M684	(B) W402
(B) A150	(B) K274	(B) M685	(B) W403
(B) A224	(B) K302	(B) M686	(B) W406
(B) A224-YA		(B) M687	(B) W410
(B) A224-YB		(B) M792-YA	(B) W730
(B) A224-YC		(B) M792-YB	(B) W731
(B) A226		(B) M792-YC	(B) W732
(B) A226-YA		(B) M792-YH	(B) W733
(B) A226-YB		(B) M792-YJ	(B) W734
(B) A226-YC		(B) M792-YK	(B) W740
(B) A233		(B) M802	(B) W741
(B) A234		(B) M803	(B) W742
(B) A235		(B) M804	(B) W743
(B) A236		(B) M805	
(B) A408		(B) M806	
(B) A614		(B) M807	
(B) A633		(B) M873-YA	
(B) A903			
(B) A904			
(B) A905			

Title						HANDLING OF MOS DEVICES		Tech Tip Number		MOS-TT-1	
All		Processor Applicability				Author		Rev		Cross Reference	
X						ART ZINS		Date 11/7/72			
						Approval		ART ZINS			

Due to the high input impedance of MOS (metal oxide semiconductor) devices, they are susceptible to damage from static discharge. These devices, such as the Intel 1103-1, are employed extensively on the G401 MOS memory matrix for the PDP-11/45.

Many manufacturers of MOS devices use various types of internal protection against damage from static discharge. These types of protection range from Zener diodes to limiting resistors. However, the effectiveness of these protection schemes is questionable and many manufacturers suggest that additional precautions be taken to ensure safe handling of these devices.

Of course the precautions taken in the factory are more extensive than those that are practical for field implementation. However, the following information should be helpful for field handling of MOS devices.

1. Choose a work area that exhibits minimal potential for the generation of static electricity.
2. Use a power receptacle that has a connection to earth ground.
3. Only use a soldering iron that offers a 3 wire ground such as the new DEC-supplied soldering iron (DEC Part No. 29-13452). Do not use a transformer type soldering iron.
4. If you are sitting in a chair while working with MOS devices, it is suggested that the chair be electrically connected to the frame of the work table. If this is not possible, use care to prevent the chair from touching the work table, thus preventing a static discharge from the chair to the work table.
5. Removal of defective MOS devices from a module requires no special handling procedures. MOS devices, once soldered on the board, offer no danger of damage from static discharge.
6. If you are standing while handling MOS devices, avoid rubbing your clothing against the work table or near by furniture, thereby preventing the build up of static electricity.
7. MOS devices (as supplied by DEC) are packaged in a conductive plastic bag. Before opening the bag, touch the work table or metal connected to it to discharge any static build up.

COMPANY CONFIDENTIAL

digital	FIELD SERVICE TECHNICAL MANUAL				Option or Designator
	12 Bit <input checked="" type="checkbox"/>	16 Bit <input checked="" type="checkbox"/>	18 Bit <input checked="" type="checkbox"/>	36 Bit <input checked="" type="checkbox"/>	MOS DEVICES

Title					HANDLING OF MOS DEVICES (Continued)		Tech Tip Number MOS-TT-1		
All	Processor Applicability				Author	ART ZINS	Rev	Ø	Cross Reference
X					Approval	ART ZINS	Date	11/7/72	

8. Empty the contents of the bag onto the work area without touching the MOS devices.
9. Prior to touching the MOS device, always discharge yourself by touching the work area or attached metal.
10. Insert the MOS device into the module using care to ensure minimal handling of the device leads. Try to grasp the chip by the body of the device and not by its leads.
11. Replace the unused spare MOS devices in the conductive plastic bag by grasping the body of the IC, after previously discharging yourself against the work table. Reseal the bag using tape or a stapler.

All of the above precautions are to reduce the possibility of a potential difference between the MOS device being handled and the surrounding environment. Again, common sense is essential when choosing a good work area and method of handling these devices.

-- NOTES --

digital	FIELD SERVICE TECHNICAL MANUAL				Option or Designator
	12 Bit <input checked="" type="checkbox"/>	16 Bit <input type="checkbox"/>	18 Bit <input type="checkbox"/>	36 Bit <input type="checkbox"/>	MR8E TO MR14

Title Diagnostic Difficulties with ROM's				Tech Tip Number MR8E-TT-1	
All		Processor Applicability		Author Jeff Blundell	Rev 0
<input type="checkbox"/> 8E	<input type="checkbox"/> 8M	<input type="checkbox"/> 8F	<input type="checkbox"/>	Approval F. Purcell	Date 11/20/72
					Cross Reference

The MR8E is a 256 word Read Only Memory (ROM) and can in no way have its contents changed by program control. It follows therefore than the only way to test it is to compare its contents against a table that lists what should be in the ROM.

There are two (2) problems currently associated with the MR8E ROM.

- 1) A number of problem reports have been received saying that extended memory control test (Maindec-08-DHCMA-A) fails when there is a ROM in the configuration. This is to be expected. The program will halt at 2263 to tell you memory has been found in an area that supposedly contained none. (Most ROM's are used as a bootstrap in field 7), and this is a legitimate halt. If you want to test extended memory, then remove the ROM temporarily. The error halt can be useful however, to check that the ROM is only answering to addresses that belong to it, or to locate the starting address of a ROM if you don't want to go diode hunting to see what it is set up for.
- 2) Maindec-8E-D1JB (MR8E Test) is full of mistakes. It does a good test if the ROM is okay, but if you have errors then it bombs itself and print inaccurate error information. The current MCN's do NOT correct the problem, and a new version of the program is about to be issued. Most ROM problems, incidently, are due to bad corrections at the ends of either the current wires or the sense wires. Re-soldering, being sure to tin the wire, will usually fix it.

COMPANY CONFIDENTIAL

Title MR14 REPLACEMENTS AND CHANGES				Tech Tip Number MR14-TT-1		
All	Processor Applicability			Author L. Goelz	Rev B	Cross Reference
	14			Approval G. Chaisson	Date 01/24/73	

A second vendor for the PDP-14 ROM (MR14) is now being used. The new vendor is DATAPAC. The option designation for the new unit is still MR14. This ROM eliminates broken core problems.

The two (2) makes of ROMs, M.T.I. and DATAPAC are pin for pin compatible. They may be used side by side; i.e., first 1K is M.T.I., second 1K is DATAPAC. However, individual modules of the ROMs may not be interchanged.

As with the M.T.I. ROM, the DATAPAC comes in three units. They are the sense board, the driver board and the braid board. Listed below are the DEC Vendor part numbers.

VARIATIONS	DATAPAC #	DEC #
Complete package	6ØØ61Ø	3Ø-112Ø8-ØØ
Braid Board & Conn	6ØØ617	3Ø-112Ø8-Ø1
Sense Board	1ØØ614	3Ø-112Ø8-Ø2
Driver Board	1ØØ611	3Ø-112Ø8-Ø3

MEMORY TECHNOLOGY INC (M.T.I.) has come out with an improved version of the MR14. The change eliminates the U-core on the sense board. The new unit will eliminate broken cores in most cases and can be used just as the old MR14 was. The G924 remains the same. The braid board has the U-core elongated. The G923 has the U-cores removed and a wire wound bar in its place. The designator for this module is G923YA. Both the braid board and the G923YA cannot be intermixed with the older versions.

OLD MR14 (M.T.I.)

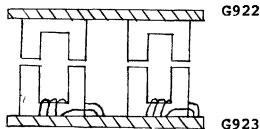

NEW MR14 (M.T.I.)

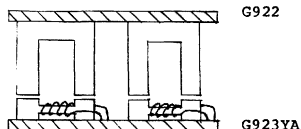

digital	FIELD SERVICE TECHNICAL MANUAL				Option or Designator
	12 Bit <input checked="" type="checkbox"/>	16 Bit <input type="checkbox"/>	18 Bit <input type="checkbox"/>	36 Bit <input type="checkbox"/>	MR14

Title MR14 REPLACEMENTS AND CHANGES				Tech Tip Number MR14-TT- 1	
All		Processor Applicability		Author L. Goelz	
				Rev B	
14				Approval G. Chaisson	
				Date 1/14/73	
				Cross Reference	

Part numbers for the above cores are:

	<u>Old MR14</u>	<u>New MR14</u>
Core wound	29-18605	29-20902
Core wound	29-18606	29-20903

Title						Tech Tip M R 14	
ROM TEST AND REPAIR						Number TT#2	
All	Processor Applicability					Author	Rev
						W. Freeman	g
					Approval	Date	Cross Reference
					W. Cummins	11/15/73	

Installation/diagnostic tests for the Read Only Memory (ROM) require:

- a. A PDP-8 family computer (4K of memory is adequate).
- b. A positive bus interface with cables.
- c. A teletype.
- d. A PDP-14 or PDP-14L with prints.
- e. MAINDEC VER-14 with document.
- f. MAINDEC LOAD-14 with document.
- g. ROM tape (SIM-14 punchout).
- h. G924 selection board.
- i. USER'S MANUAL for PDP-14.

Installation testing should consist of running VER-14 on each ROM individually for (10) minutes, allowing unit temperature to rise, while tapping lightly with a screwdriver handle on the front edges of the braid board, the G923, and the G924. New ROM units having cold solder joints at the 36-gauge wire junctions are unusually sensitive to temperature variations; therefore, it is important to run VER-14 throughout the warm-up period. Cracked or broken transformer cores normally produce error printouts when the boards are subjected to small amounts of vibration. If testing more than (1) ROM, test all of the associated G924 selection boards.

Diagnostic Tests are carried out in the same manner as the installation tests; consult the PDP-14 or PDP-14L prints to determine which component or board is causing the error printout. Total destruction of a word may be assigned to a failure of the addressing circuits, whereas loss of a single bit in a word may be assigned to an individual transformer or its sense amplifier. When an addressing failure occurs, observe the prints of the G923, G924, and M742 to effect module and component fault isolation:

Address Bit	0	1	2	3	4	5	6	7	8	9	10	11
Module	M742		G924						G923			

NOTE: Print G924-0-1 is in error:

Pin	Presently Shown	Should Be
BK2	PC100H	PC102H
CK2	PC101H	PC103H
BL2	PC102H	PC104H
CK1	PC103H	PC105H
DK1	PC104H	PC106H
DK2	PC105H	PC107H
CL2	PC106H	PC108H

COMPANY CONFIDENTIAL

digital		FIELD SERVICE TECHNICAL MANUAL				Option or Designator	
12 Bit <input checked="" type="checkbox"/>		16 Bit <input type="checkbox"/>		18 Bit <input type="checkbox"/>		MR14 to PA60A	
Title					Tech Tip		
ROM TEST AND REPAIR					MR14 - Number TT#2		
Processor Applicability				Author		Rev	
All				W. Freeman		g	
				Approval		Date	
				W. Cummins		11/15/73	
					Cross Reference		

Consult the USER'S MANUAL, Page 12-6, Figure 12-4, to determine the location of a cracked transformer, and consult print G923-0-1 to locate a failed sense amplifier.

Repair of the G922 board may entail re-soldering a 36-gauge terminal connection, replacing a 36-gauge wire, or replacing a cracked transformer core (unwound). The 36-gauge wire is normally installed by the vendor and soldered to the G922 lugs without any insulation-stripping process; it is assumed that the flux will break down this insulation. If you suspect a cold solder joint, be sure to cut the loose end of the wire as close to the lug as possible, and allow hot solder to pass over this freshly cut edge. Test the junction with an ohm meter. Replacing a 36-gauge wire (part number 29-18620) requires that the procedure for changing an ROM program be followed; observe the USER'S MANUAL pages 12-4 through 12-11. Changing a cracked core in a G922 requires placing the ROM assembly on a flat table or bench with the G923 down, removing the keeper plate and foam rubber backing, and examining the questionable unwound core. It is recommended that all cores be checked when the keeper plate and backing are removed. Never attempt to glue the pieces of a broken core together; replace a cracked unwound core with part number 29-18606.

Repair of the G923 board may entail replacing a cracked wound core, re-soldering a 36-gauge wire connection, or changing a solid state component. The G923 board should be removed from the ROM assembly by placing the ROM on a flat surface with the keeper plate down and then removing the (15) G923 holding screws. Lift the G923 carefully away from the G922 braid board. Lay the G923 on a flat surface with the cores facing up and test each core for cracks by gently pulling the two sides apart. A crack hidden beneath the windings will evidence itself when the side moves outward. Never attempt to glue the pieces of a broken core together; replace a cracked wound core with part number 29-18605. Care should be used when soldering the new core windings to the G923 circuit board to insure proper polarity; observe the nearby cores for proper wire-wrap direction and solder points. Wholesale swapping of a G923 module often proves that the new G923 module has cracked cores resulting from shock in shipping; all cores on a new G923 should be checked for cracks prior to joining this module with the braid board. Changing a solid-state component in a ROM requires exact replacement; use no substitutes.

Chuck Gamage - October 1971

COMPANY CONFIDENTIAL

Title USING TYPESETTING READER "Ø" AS A HIGH SPEED READER					Tech Tip Number PA60A-TT-1		
All 8's	Processor Applicability				Author Don Stahl	Rev 0	Cross Reference
					Approval W. Cummins	Date 7/31/72	

It may be desirable to use typesetting reader "Ø" as an 8 level high speed reader to read Maindecs into the computer. Instances where you would use this would be:

- 1) If you have DEctape problems.
- 2) If you don't have a usable TC01 or 552 Library Tape, or
- 3) If it is a disk only system.

The following changes in the PA60, PA68A, PA68F, will enable you to use reader "Ø" to read in Maindecs in place of the ASR33/35. If reader "Ø" has been set up properly for 6 level input tapes, you should not have any problem reading 8 level tapes. If problems do arise and you cannot read 8 level tape, you may have to set up the reader for 8 level operation.

If this becomes necessary, remember to re-align reader for 6 level operation after you are done using reader for maindecs. Then place 6/8 level guide in 6 level position (UP).

PA60

- 1) Delete PA60 A25 Pin D to GND (Hole 6).
Delete PA60 A25 Pin E to GND (Hole 7).
- 2) Check PA61 Slots A10 & 11 for jumpers from Pin D to Pin C - Remove, if present.
- 3) Add PA60 A25 Pin D to SW.
Add PA60 A25 Pin E to SW.
Add PA60 any GND to SW.

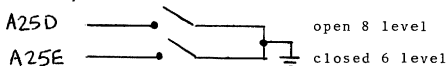

- 4) Add 2/R-141 at PA61 slots A10 & 11.
- 5) Refer to Tech Tip for 6/8 level RDR alignment.
- 6) Set 6/8 level guide for 8 level (DOWN). Reader Ø may now be used as a high speed reader. Parts required:

2/R-141 Modules
1 - Switch Assembly DPST (continued)
Wire

COMPANY CONFIDENTIAL

PAGE 438	PAGE REVISION 0	PUBLICATION DATE July 1972
----------	-----------------	----------------------------

digital	FIELD SERVICE TECHNICAL MANUAL				Option or Designator
	12 Bit <input checked="" type="checkbox"/>	16 Bit <input type="checkbox"/>	18 Bit <input type="checkbox"/>	36 Bit <input type="checkbox"/>	PA60A

Title USING TYPESETTING READER "0" AS A HIGH SPEED READER (Continued)				Tech Tip Number PA60A-TT-1	
All	Processor Applicability		Author Don Stahl	Rev 0	Cross Reference
8's			Approval W. Cummins	Date 7/31/72	

- 1) Delete PA68A B13F to GND.
Delete PA68A B13M to GND.
- 2) Add PA68A B13F to SW.
Add PA68A B13M to SW.
Add PA68A any GND to SW.
- 3) Refer to Tech Tip for 6/8 level reader alignment. Reader may now be used as a high speed reader.
- 4) Set 6/8 level guide for 8 level (DOWN). Parts required:
1/switch assembly DPST
wire

PA68F

- 1) Delete PA68F B10H2 to GND.
Delete PA68F B10E1 to GND.
- 2) Add PA68F B10E1 to SW.
Add PA68F B10H2 to SW.
Add PA68F any GND to SW.

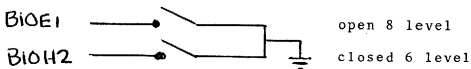

- 3) Refer to Tech Tip for 6/8 level reader alignment.
- 4) Set 6/8 level guide for 8 level (DOWN). Reader may now be used as a high speed reader. Parts required:
1/switch assembly DPST
wire

Title CLARIFICATION AND CORRECTION OF TYPESETTING ECO'S				Tech Tip Number PA60A-TT-2	
All	Processor Applicability		Author Fred Miller	Rev 0	Cross Reference
8's			Approval W. Cummins	Date 7/31/72	

Title ERRATIC PUNCH OUTPUT FROM PUNCHES ON A PA60 CONTROL				Tech Tip Number PA60A-TT-3		
All 8's	Processor Applicability			Author Fred Miller	Rev \emptyset	Cross Reference
				Approval W. Cummins	Date 7/31/72	

Complete all punch adjustments detailed in Tech Tip "Punch Adjustment Procedure" Section 4, Page 21. If there is still unreliable operation such as holes being picked up or dropped, characters being punched on top of other characters, or blank frames of tape, check the Schmitt trigger in the PA60 control.

The W501 Schmitt trigger (B32) might not be operating properly. The output pulses may vary radically in width and frequency with the punch running constantly. The problem may be that pin R, the input is clamped to about 2½ to 2¾ volts. The problem can be solved by taking the 2 ma. clamp load (Pin D) off the input (Pin R), and the 10 ma clamp off the output (Pin F) and switching them. This results in having the input clamped with 10 ma clamp load, and the output clamped with the 2 ma clamp load. This causes the input to go to -3V and, as a result, reliable operations of the W501.

Reference print PA60-A-4 circuit changed as follows:

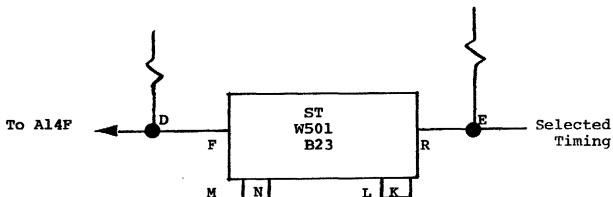

COMPANY CONFIDENTIAL

PAGE 440	PAGE REVISION 0	PUBLICATION DATE July 1972
----------	-----------------	----------------------------

digital	FIELD SERVICE TECHNICAL MANUAL				Option or Designator
	12 Bit <input checked="" type="checkbox"/>	16 Bit <input type="checkbox"/>	18 Bit <input type="checkbox"/>	36 Bit <input type="checkbox"/>	PA60C

Title PA60C OPTION				Tech Tip Number PA60C-TT-1	
All Processor Applicability		Author John Gleeson	Rev \emptyset	Cross Reference	
8's		Approval W. Cummins	Date 07/31/72		

The PA60C option (which will control up to 16 readers) provides a user with a "non-torn tape" system. The paper tape from the keyboard perforator is left in the reader with the tape arm down and initiation of reader selection is begun by pressing a push button mounted on the reader. An indicator lamp, also mounted on the reader, will be extinguished and, provided that no other tape is being processed, the computer will proceed to read and justify the tape. The end of a "take" is indicated by a "stop" code which has been punched on the tape by the operator. When this code is sensed, reading is discontinued and the indicator lamp on the reader lights again. Thus, an operator is free to perforate tape continuously, except for the pushing of a button to signal the computer that a take is ready for processing.

BASIC THEORY OF OPERATION

Reader selection is made in the PA60A and/or PA60B (see print BS-PA60-A-2, and Diagram #1) which generates select reader levels used to gate the outputs of A and B flip-flops in order to drive the stepping motors in the PR68A Readers (see print BS-PA61-A-3). Further control over reader selection is made by ANDING the Select Reader signals with the outputs of the reader selection in the PA60C.

INITIAL CONDITIONS

On power up and Key Start, Power Clear (produced in the computer) is used to set all R202's in the PA60C to the "1" state. The output from each R202 is taken to two (2) W051's, one being used to control the indicator lamp on the reader and the other to control Select Reader signals. A ground level on the output from each "Select" W051 will inhibit reader selection by the PA60A or PA60B logic. Thus, on power up all readers are de-selected with the exception of reader \emptyset which uses the opposite state of the RDR01 flip-flop for selection. This is for purposes of program read-in since the Typesetting Rim Loader uses reader \emptyset for reading program tapes, bootstrap tapes, etc. Selection of reader \emptyset is controlled by the RDR01 logic in the PA60C; #1 by the RDR02; #15 by RDR16.

When the typesetting program is started, it sequentially steps through reader selection searching for a selectable reader; i.e. one with tape in it, the tape arm down and for which the button has been pressed; for example, assume readers #1, 2 and 6 are selectable. The first IOT 312 will deselect reader \emptyset , reset RDR01 flip-flop, find reader #1 selectable and will begin processing the tape (See READER SELECTION, next page). When processing is complete the next IOT 312 will deselect reader #1.

COMPANY CONFIDENTIAL

Title PA60C (Continued)		Tech Tip Number PA60C-TT-1	
All	Processor Applicability	Author John Gleeson	Rev 0
8's		Approval W. Cummins	Date 07/31/72
			Cross Reference

INITIAL CONDITIONS (Continued)

Set RDR02 Flip-Flop and check Reader #2. This is selectable so the tape in Reader #2 will be processed. When processing is complete the third IOT 312 will deselect Reader #2, set RDR03 Flip-Flop and check Reader #3. This is not selectable so another IOT 312 will be given which will check reader #4. This continues until another selectable reader is found, in this example reader #6. When the tape in this reader has been processed, reader #6 will be deselected, RDR07 Flip-Flop set and Reader #7 checked. After reader #15 has been checked, searching will begin again at Reader #0.

Note that if Reader #0 is selectable when the typesetting program is started, (the button pushed after start but before the program is loaded) it will be deselected by the first IOT312. It will be selected again only after the program has checked through the other readers in the system and provided, of course, that the operator at Reader #0 has again pressed the button.

READER SELECTION

(See Diagram #1) - Example, when an operator at Reader #1 is ready to have a "take" processed, he presses the push button mounted on his reader. The closing of its contacts produces a positive going transition from the W700 switch filter in slot C06 (Pin K). This pulse resets the RDR03 flip-flop in slot D09. The indicator lamp on the reader will be extinguished by the W051 at C09, Pin F. The SELECT READER 02 signal from the PA60A will hold the output from the W051 at C10 Pin F, at ground, and level RS01 will be at -3V. When the operator selected reader becomes program selected, both SELECT READER signals will be at -3V, thus, tape processing will begin. When the stop code at the end of the tape is read, tape processing is stopped, some housekeeping is performed and then the program begins to stop through reader selection again. The IOT312 which began tape processing allowed RS01 to go to ground. The DCD gate for the Flip-Flop is now enabled and hence the first IOT312 following tape processing will set Flip-Flop to the "1" state, thus, deselecting the reader and lighting the indicator lamp on reader "1".

INHIBIT FACILITY

Mounted on the PA60B/C logic frame is a toggle switch. When switched to the OFF position this provides an inhibit level which is used to hold all reader select Flip-Flops in the "0" state; i.e.; permanently selected. Thus, a selectable reader is redefined as a reader with tape in it and the tape arm down, but without the requirement for pressing the reader push button. PA60C-1-2, revision C and below do not show this inhibit logic.

COMPANY CONFIDENTIAL

digital	FIELD SERVICE TECHNICAL MANUAL				Option or Designator
	12 Bit <input checked="" type="checkbox"/>	16 Bit <input type="checkbox"/>	18 Bit <input type="checkbox"/>	36 Bit <input type="checkbox"/>	PA60C

Title PA60C (Continued)				Tech Tip Number PA60C-TT-1	
All Processor Applicability		Author John Gleeson	Rev -g	Cross Reference	
g's		Approval W. Cummins	Date 07/31/72		

INSTALLATION

The PA60B is a two (2) rack control which is pre-wired to include the PA60C option. The PA60C option is implemented by inserting extra modules in the PA60B interface as per UML-PA60B-1. If a PA60C is being added in the field, cable interconnections are as follows:

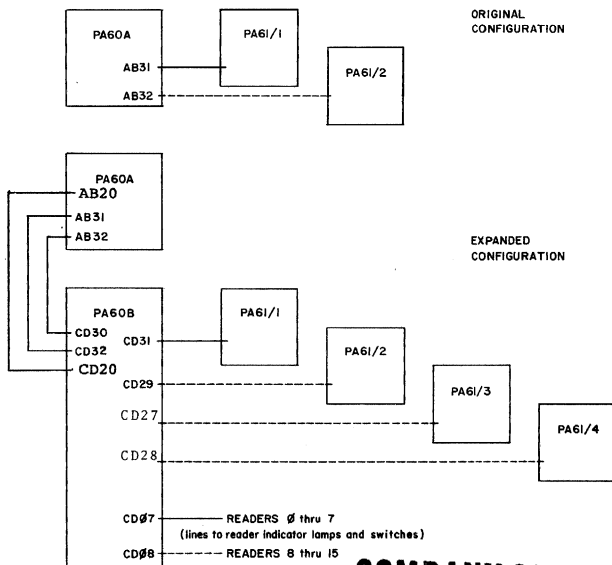

COMPANY CONFIDENTIAL

Title PA60C (Continued)					Tech Tip Number PA60C-TT-1	
Processor Applicability			Author John Gleeson	Rev 0	Cross Reference	
All 8's			Approval W. Cummins	Date 07/31/72		

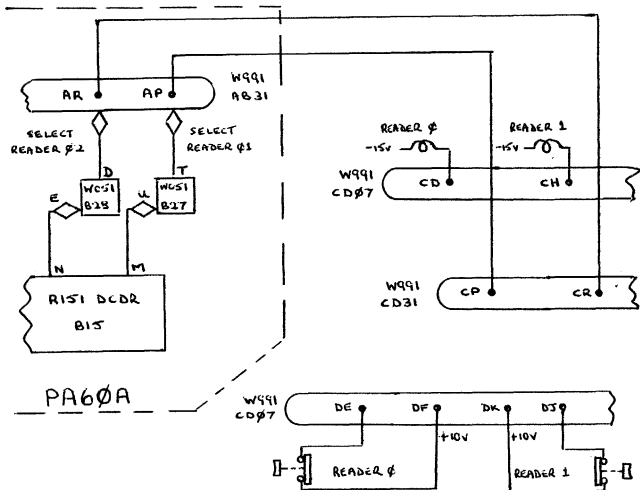

NOTE: Interconnections are not shown on PA60B/C prints.

DIAGRAM 1 - Example of Logic Interconnection
(Refer to Print PA60-C-1)

COMPANY CONFIDENTIAL

digital	FIELD SERVICE TECHNICAL MANUAL				Option or Designator
	12 Bit <input checked="" type="checkbox"/>	16 Bit <input type="checkbox"/>	18 Bit <input type="checkbox"/>	36 Bit <input type="checkbox"/>	PA60C to PA61A

Title PA60C (Continued)				Tech Tip Number	PA60C-TT-1	
All 8's	Processor Applicability			Author John Gleeson	Rev 0	Cross Reference
				Approval W. Cummins	Date 07/31/72	

PARTS LIST

Listed below are relevant part numbers for the PA60C modification:

	<u>DESCRIPTION</u>	<u>QUANTITY REQUIRED</u>	<u>PART NUMBER</u>
"Select"	Switch Box	1 per reader	76-Ø5424
Switch	Grayhill Switch #22Ø1	1 per reader	12-Ø2995
	Sub-miniature Toggle Switch	1	12Ø1168
"Inhibit"	Phillips Panhead M/C Screw 8/32x11/4LG 2		9ØØ6Ø44-1
Switch	Spacer 1/4 O.D. #6 CL Hole 1LG	2	
	Switch Mounting Bracket	1	74Ø5269
	Dialco 1ØIR Light	1 per reader	12-4628
	Light Bulb 33Ø	1 per reader	12-2986
	Jones Terminal Strip #4-140	1 per reader	9Ø-Ø69Ø1

John Gleeson

December 1970

COMPANY CONFIDENTIAL

Title PA61A UNUSED READER SLOTS						Tech Tip Number PA61A-TT-1	
All Processor Applicability				Author P. Tinkham		Rev g	
8's				Approval W. Cummins		Date 07/31/72	
Cross Reference							

A false indication of tape being read can result from unused reader slots in the PA61A logic. With no reader connected to the PA61A logic, "feed hole" will float more negative than 0.7 volts falsely indicating tape in the reader. Since the typesetting program does not know how many readers are available in the system it must check each one. Sequentially looking at readers \emptyset -15, it in turn gives each one a read command and then checks for a reader flag. In existing readers (assuming no tape is in the reader) "feed hole" will be at ground and the flag will not be set. The program will then go on to the next reader. If the program tries to check a reader number where none exists or is not plugged in, "feed hole" will be floating negative enough to set the flag and will erroneously indicate a reader with tape. This will cause the program to hang up on the false reading of rubout codes.

This problem is most likely to occur when:

- 1) The system has just been installed and the typesetting program is being run for the first time.
- 2) A reader has been temporarily taken off line for repairs, etc.

The problem can be solved by connecting the "feed hole" inputs of all unused reader slots to ground. Locate the correct points in Table 1 and jumper all unused reader slots to the nearest ground. If a reader was taken off line temporarily, remember to remove the jumper when the reader is back in service.

PA61A Number	Reader Number	Pin Grounded
1	\emptyset	A1H
1	1	A2H
1	2	B1H
1	3	B2H
2	4	A1H
2	5	A2H
2	6	B1H
2	7	B2H
3	8	A1H
3	9	A2H
3	10	B1H
3	11	B2H
4	12	A1H
4	13	A2H
4	14	B1H
4	15	B2H

COMPANY CONFIDENTIAL

digital	FIELD SERVICE TECHNICAL MANUAL				Option or Designator
	12 Bit <input checked="" type="checkbox"/>	16 Bit <input type="checkbox"/>	18 Bit <input type="checkbox"/>	36 Bit <input type="checkbox"/>	PA61A TO PA63

Title 30 VOLT POWER SUPPLY PROBLEMS				Tech Tip Number PA61A-TT-2	
All Processor Applicability			Author Paul Tinkham	Rev #	
8's			Approval W. Cummins	Date 07/31/72	
			Cross Reference		

There are two problems associated with the 30 volt power supply used on all typesetting systems. This is the G799 power supply (G799A for 240V/50 HZ) which supplies -30 volts for the PA61A and PA68A, and +30 volts for the PA63 and PA68F controls. The absence of a bleeder resistor on the 30 volt line has caused reader modules to be blown when inserting or removing the reader cable even with all power turned off. The other problem is excessive noise on the line when both the reader and punch are operating, causing various intermittent problems.

Both of these problems were solved by ECO number PA61-A-00003, but most units shipped to date have not had this change incorporated. The ECO consists of addition of a 500 ohm/25 watt bleeder resistor and a 50 mfd/50 volt bypass capacitor in parallel across the 30 volt output. This change applies to all controls (PA61A, PA68A, PA63, PA68F) and must be added if not already present to expect proper operation. See Figure 1 for correct wiring and parts numbers.

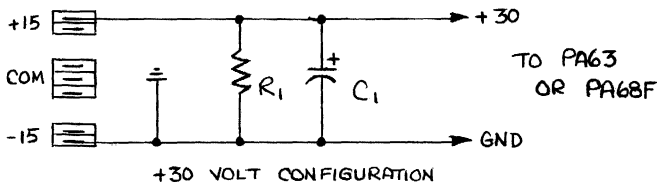
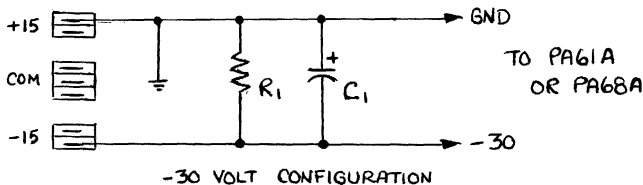

FIG. 1 - G799* POWER SUPPLY

PARTS REQUIRED:

*G799A - 240V/50 HZ.

1	R1	13-00333	500 OHM 25 WATT RESISTOR
1	C1	10-00080	50 MFD 50 VOLT CAPACITOR

Title 30 VOLT POWER SUPPLY PROBLEMS						Tech Tip Number PA63-TT-1	
All 8's	Processor Applicability				Author P. Tinkham	Rev 0	Cross Reference PA61A-TT-2
					Approval W. Cummins	Date 07/31/72	

Title WARNING ABOUT M710 PUNCH CONTROL MODULE						Tech Tip Number PA63-TT-2	
All 8's	Processor Applicability				Author Fred Miller	Rev 0	Cross Reference PA68F-TT-3
					Approval W. Cummins	Date 07/31/72	

Title CLARIFICATION AND CORRECTION OF TYPESETTING ECO'S						Tech Tip Number PA63-TT-3	
All 8's	Processor Applicability				Author F. Miller	Rev 0	Cross Reference PR68-TT-9
					Approval W. Cummins	Date 07/31/72	

Title PA63/PA68F						Tech Tip Number PA63-TT-4	
All 8's	Processor Applicability				Author P. Bezeredi	Rev 0	Cross Reference TYPESET SETWRE-TT-6
					Approval W. Cummins	Date 07/31/72	

Title NOISE ON IOP2						Tech Tip Number PA63-TT-5	
All 8's	Processor Applicability				Author R. Boehm	Rev 0	Cross Reference
					Approval F. Miller	Date 8/9/73	

Some PA63's were wired with the IOP2 line to C07E1 running parallel with the 30V wires on C row. The 30V runs induce noise into IOP2 line causing errors. If this problem occurs reroute the IOP2 line so that it runs down "B" row to B07 and then down to C07E 1.

The problem that occurs is the Reader Select Buffer being loaded at the wrong time with the wrong value, thus deselection the reader that is running. Usually shows up while running Test 07, typeset configuration test.

PAGE 448	PAGE REVISION 0	PUBLICATION DATE July 1972
----------	-----------------	----------------------------

digital	FIELD SERVICE TECHNICAL MANUAL				Option or Designator
	12 Bit <input checked="" type="checkbox"/>	16 Bit <input type="checkbox"/>	18 Bit <input type="checkbox"/>	36 Bit <input type="checkbox"/>	PA68A

Title USING TYPESETTING READER "0" AS A HIGH SPEED READER				Tech Tip Number	PA68A-TT-1
All	Processor Applicability		Author Don Stahl	Rev 0	Cross Reference
8's			Approval W. Cummins	Date 07/31/72	PA60A-TT-1

Title CLARIFICATION AND CORRECTION OF TYPESETTING ECO'S				Tech Tip Number	PA68A-TT-2
All	Processor Applicability		Author Fred. Miller	Rev 0	Cross Reference
8's			Approval W. Cummins	Date 07/31/72	PR68-TT-8

Title 30 VOLT POWER SUPPLY PROBLEMS				Tech Tip Number	PA68A-TT-3
All	Processor Applicability		Author P. Tinkham	Rev 0	Cross Reference
8's			Approval W. Cummins	Date 07/31/72	PA61A-TT-2

-- NOTES --

digital	FIELD SERVICE TECHNICAL MANUAL				Option or Designator
	12 Bit <input checked="" type="checkbox"/>	16 Bit <input type="checkbox"/>	18 Bit <input type="checkbox"/>	36 Bit <input type="checkbox"/>	PA68F

Title USING TYPESETTING READER "0" AS A HIGH SPEED READER				Tech Tip Number	PA68F-TT-1
All Processor Applicability		Author Don Stahl	Rev 0	Cross Reference	
8's		Approval W. Cummins	Date 07/31/72	PA60A-TT-1	

Title CLARIFICATION AND CORRECTION OF TYPESETTING ECO's				Tech Tip Number	PA68F-TT-2
All Processor Applicability		Author Fred Miller	Rev 0	Cross Reference	
8's		Approval W. Cummins	Date 07/31/72	PR68-TT-8	

Title WARNING ABOUT M710 PUNCH CONTROL MODULE				Tech Tip Number	PA68F-TT-3
All Processor Applicability		Author Fred Miller	Rev 0	Cross Reference	
8's		Approval W. Cummins	Date 07/31/72		

If you don't like to rebuild PP67C and PP67D (Teletype BRPE) punches don't pull the M710 module out of PA68F or PA63 controls and leave power on.

When the M710 is out of the circuit, the M113 input gates float. This will turn on the M060 modules and drive maximum current through each solenoid of the punch that is selected. Within a few minutes smoke begins to appear as the windings of the solenoids begin to melt together and the green 10 watt resistors underneath the punch turn shades of amber.

If you must have the M710 out of the circuit, remember to tie the input gates of the M113 high.

Title 30 VOLT POWER SUPPLY PROBLEMS				Tech Tip Number	PA68F-TT-4
All Processor Applicability		Author P. Tinkham	Rev 0	Cross Reference	
8's		Approval W. Cummins	Date 07/31/72	PA61A-TT-2	

COMPANY CONFIDENTIAL

Title PA68F CONVERSION PROBLEM - 6 to 8 level						Tech Tip Number PA68F-TT-5		
All Processor Applicability						Author P. Tinkahm Rev 0		Cross Reference
8's						Approval W. Cummins Date 07/31/72		

When a PA68F (Positive Logic Single Reader/Punch Control) is used for 6 level operation, the "one" side of RD7 and RD6 flip-flops are wired to ground. This keeps RD7 and RD6 from ever setting to a "one". Reference print D-BS-PA68-F-1 Rev. H.

Conversion of a PA68F to 8 level operation required removal of the grounds (B10E1, B10H2 to Ground). There is a good possibility that RD7 and RD6 will fail to operate properly even with the grounds removed. This is due to the fact that grounding these points might blow out the IC chips for RD7 and RD6.

Solution of the problem is either replacing the M216 in slot B10 or replacing the appropriate IC's on the module after the grounds are removed. An upcoming ECO will alter the method of disabling RD7 and RD6 thus alleviating the problem.

Title PA63/PA68F Typesetting Configuration Tests						Tech Tip Number PA68F-TT-6		
All Processor Applicability						Author P. Tinkahm Rev 0		Cross Reference
8's						Approval W. Cummins Date 07/31/72		

COMPANY CONFIDENTIAL

digital	FIELD SERVICE TECHNICAL MANUAL				Option or Designator PC01
	12 Bit <input checked="" type="checkbox"/>	16 Bit <input type="checkbox"/>	18 Bit <input checked="" type="checkbox"/>	36 Bit <input type="checkbox"/>	

Title PC01 PUNCH MOTOR REPLACEMENT				Tech Tip Number PC01-TT-1	
All	Processor Applicability			Author Sweeney/Elms	Rev 0
X				Approval E. Purcell	Date 7/31/73
					Cross Reference

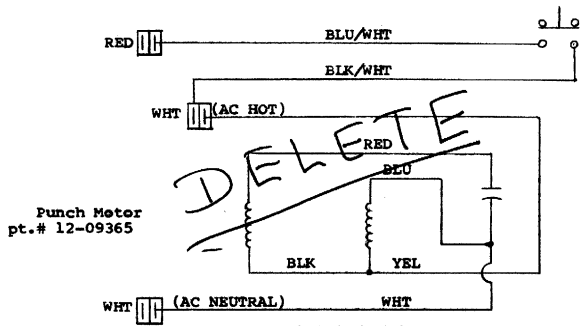
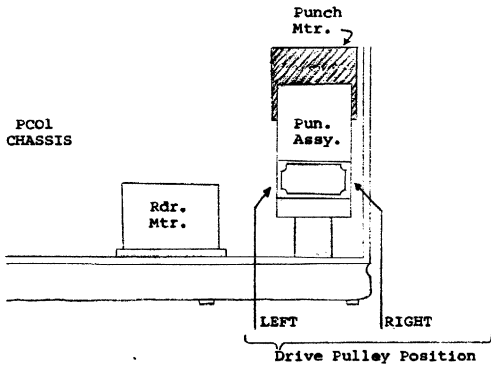

Punch Motor
pt.# 12-09365

COMPANY CONFIDENTIAL

Title						Tech Tip	
PC01 PUNCH MOTOR REPLACEMENT						Number PC01-TT-1	
Processor Applicability						Author	
All						Sweeney/Elms	
X						Rev 1	
						Approval	
						E. Purcell	
						Date	
						7/31/73	
						Cross Reference	

There are currently two kinds of motors in stock as replacements for the PDP-8 Family series of High Speed Punch Assemblies.

These are:

12-05383 GE 5KPM49EG190 (stamped: CW) old, PC01
 12-09365 GE 5KPM49EG276A (stamped: CCW) new, PC04

These motors are not interchangeable. If the wrong one is installed the Punch will run backwards (adding considerably to tape assembling time).

The restrictions for use of these motors are as follows; (refer to accompanying drawing):

On punch assemblies where the drive pulley is at the left, motor 12-05383 is to be used. If the drive pulley is located on the right, then motor 12-09365 must be used.

Aside from the difference in armature rotation, motor 12-05383 has five leads whereas motor 12-09365 has only four.

*For information purposes only, new style Punch Assemblies with the longer input shaft (pt.#29-19881; equal length at both ends), can be set-up for either right or left hand drive.

COMPANY CONFIDENTIAL

digital	FIELD SERVICE TECHNICAL MANUAL				Option or Designator PC02
	12 Bit <input checked="" type="checkbox"/>	16 Bit <input type="checkbox"/>	18 Bit <input type="checkbox"/>	36 Bit <input type="checkbox"/>	

Title PC02 READER ADJUSTMENT				Tech Tip Number PC02-TT-1	
All <input checked="" type="checkbox"/>	Processor Applicability			Author	Rev
				Approval W. Cummins	Date 7-31-72
					Cross Reference

If a PC02 is found to be difficult to adjust, it may be that the G904 Photo Amplifier has not been modified. The modification is as follows:

1. Change eight (8) 12K ohm resistors ("A" in drawing below) to 100K ohm, 1/4 W, 5% (DEC Part #13-2466).
2. Change nine (9) 3K and 1K ohm resistors (B) to 100 UF capacitors (DEC #10-00016).
3. Change 3.9K ohm (or may be 7.5K) resistor (C) to 27K ohm, 1/4W (DEC #13-5346).
4. Replace the 2.2K ohm resistor (D) with a jumper wire.
5. Replace the ZENER diode (E) with a 1N750A ZENER (DEC #11-00124).
6. Remove nine (9) .01UF capacitors (F) from the card; there should be only one (1) .01UF remaining on the card, (X).

NOTE: The G9-4 should be adjusted for a 50/50 duty cycle using an alternate ones/zeros tape.

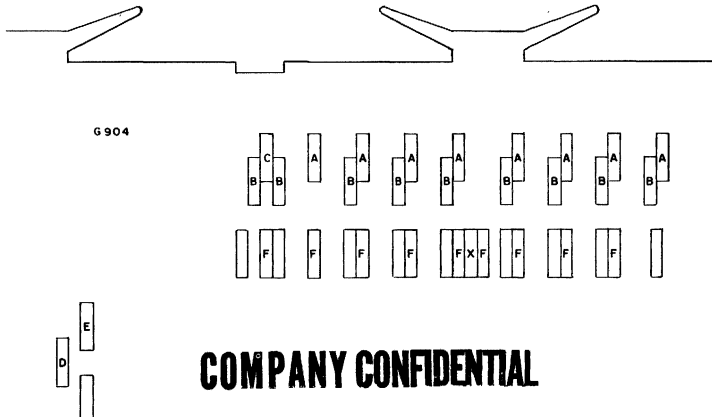

COMPANY CONFIDENTIAL

Title										Tech Tip	
PCO2 MOTOR EXCHANGE										Number	
Processor Applicability										PCO2-TT-2	
All										Author	
X										Sweeney/Groves	
										Rev	
										A	
										Approval	
										F. Purcell	
										Date	
										7/31/73	
										Cross Reference	

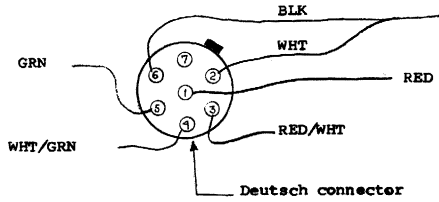
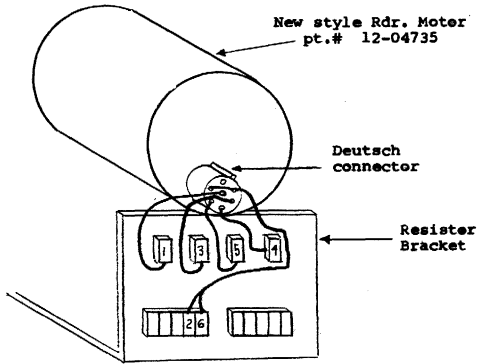

COMPANY CONFIDENTIAL

digital	FIELD SERVICE TECHNICAL MANUAL				Option or Designator
	12 Bit <input checked="" type="checkbox"/>	16 Bit <input type="checkbox"/>	18 Bit <input checked="" type="checkbox"/>	36 Bit <input type="checkbox"/>	PC02

Title					Tech Tip	
PC02 MOTOR EXCHANGE					Number	
Processor Applicability					PC02-TT-2	
All			Author	Sweeney/Groves	Rev	A
X			Approval	F. Purcell	Date	7/31/73
					Cross Reference	

If a motor must be replaced in an older PC02 Reader, the newer type oil-damped unit will be supplied. Due to difference in the forward bearing housing between the units, a new mounting plate will also be required.

The older style motor can be easily identified by the absence of an oil-port screw and the presence of wires connected internally to the motor.

On the newer type motor, power connections are made available at the rear of the unit via a Deutsch connector.

When replacing an old motor, order both the following items:

12-04735	Motor	\$298.00
74-05941	Mounting Plate	\$ 57.00

The accompanying drawings will aid you with the installation of the new unit.

-- NOTES --

CPL

digital	FIELD SERVICE TECHNICAL MANUAL				Option or Designator
	12 Bit <input checked="" type="checkbox"/>	16 Bit <input type="checkbox"/>	18 Bit <input type="checkbox"/>	36 Bit <input type="checkbox"/>	PC03

Title				PC03 POWER LINE CROSS TALK		Tech Tip		Number		PC03 TT#1			
All		Processor Applicability				Author		W. Freeman		Rev		Ø	
8						Approval		W.E. Cummins		Date		11/14/73	
												Cross Reference	

When punching several channels within a character, large spikes are produced on the -30V line. With present wiring runs these spikes can be induced onto other D.C. power lines and logic lines.

This problem is worse when the processor is time sharing with the punch (not waiting for the flag) and has caused failures of user programs at several installations.

Remove the two -30V lines to the punch and the punch drivers. Re-wire, routing the wiring direct and away from other wiring. For example, the -30V to the punch drivers is best taken around the right hand side of the interface as viewed from the wiring side.

COMPANY CONFIDENTIAL

-- NOTES --

digital	FIELD SERVICE TECHNICAL MANUAL				Option or Designator
	12 Bit <input checked="" type="checkbox"/>	16 Bit <input checked="" type="checkbox"/>	18 Bit <input checked="" type="checkbox"/>	36 Bit <input checked="" type="checkbox"/>	PC04

Title PC04 READER ADJUSTMENT PROCEDURE				Tech Tip Number PC04-TT- 1	
All Processor Applicability		Author A. Newbery		Rev 0	
X		Approval W. Cummins		Date 6/6/72	
				Cross Reference	

1. All power must be off while the following checks are made.
 - a. Check fuses for proper type and rating; they must be 3 Amp., slow blow.
 - b. Check for continuity between reader lamp ground detent and chassis ground.
 - c. Check the following wires for proper connection:

COLOR		LOCATION	COLOR		LOCATION
black (str)	+	BØ9C	wh/blue	*	AØ7B
wh/black (str)	#	BØ7C	wh/green	*	BØ1B
brown (str)	#	AØ1N	brown (solid)	#	BØ3R, BØ3S
yellow (str)	#	AØ1V	orange (solid)	#	BØ4R, BØ4S
wh/yellow (str)	#	AØ8F	yellow (solid)	#	BØ5R, BØ5S
white (str)	+	BØ1U	violet (solid)	#	BØ6R, BØ6S
grey/red (str)		AØ8A	+ if PCØ4 includes punch		
grey/yellow (str)		AØ8B	* only on PCØ4C configuration		
blue (str)		BØ6V	# if PCØ4 includes reader		

- d. With the reader lamp in position, see that the tension on the lamp is sufficient for good contact.
2. Apply AC power to the unit and check for:
 - a. +5, ±.5 volts on AØ8A and BØ8A. This voltage is usually 4.3 to 4.6 volts with a .2 to .3 volt ripple.
 - b. -15, ±1 volts on AØ8B and BØ8B. Large fluctuations in this voltage will make adjustment of the G918 impossible.
 - c. -30 to -40 volts on BØ6V and BØ2D.
3. Check for 6.8uf, (# 10-5306) capacitors between pins AØ3A (+) and AØ3C (-) and between pins BØ3C (+) and BØ3B (-).
4. Reader adjustments:
 - a. Secure reader lamp and rotate it into such a position that the seam in the glass bulb does not distort the portion of the light beam which illuminates the photo cells.
 - b. Loosen read head guide plate, press it downward gently against three thicknesses of tape and secure it. (be certain that the plate is positioned so that it will not obstruct the light to the photohead and that the plate is parallel to the platform)
 - c. Center motor bolts in slotted motor mount holes.
 - d. Adjust sprocket wheel so that tape data holes are centered over the photo cells and the edge of the tape is against the back plate. This is the tape guide so be sure that the tape is against the back plate but doesn't bind or ride up the side.
 - e. Reader tape depressor adjustment:
 1. Loosen the two screws which hold the fork.
 2. Adjust the depressor so that it does not touch the sprocket teeth. With minimum pressure, hold the fork down and tighten the two screws. The fork should be held against the sprocket wheel by spring tension.

Title PC04 READER ADJUSTMENT PROCEDURE (Continued)						Tech Tip Number PC04-TT-1		
All X_i	Processor Applicability					Author A. Newbery	Rev 0	Cross Reference
						Approval W. Cummins	Date 6/6/72	

4. Reader adjustments continued:
- Adjust lamp voltage for 3.8 to 4.1 volts for best adjustment of the G918.
 - Adjust condenser so that maximum light falls on the cells.
 - The M715 adjustments are the same as those for a PC8I/8L; refer to 8I/8L Field Service Tech Manuals Section 4, Page 1 for this procedure.
 - Cycle a 0's and 1's tape through the reader at full speed.
 - Adjust potentiometer on the amplifier module (G918) so that all data holes cause readout. NOTE: if potentiometer adjustment does not allow all holes to be read check the strobe position and adjust it so that all holes are read. Strobe adjustment is made by rotation of the motor on its mounting plate or rotation of the sprocket wheel on its shaft.
 - Look at data pulses (sync negative, internal on scope) and adjust amplifier potentiometer for an on/off percentage ratio of 42/58 on the longest data pulse. It is possible that this ratio may not be obtainable; in this case, adjust the variable resistor in the reader lamp circuit until the ratio is obtained.
 - Check on/off ratio of all data pulses. The minimum ratio must be greater than 25/75. If the minimum on/off ratio is greater than 30/70 adjust the amplifier potentiometer to reduce it to 30/70 or less.
 - Determine the earliest rising and the latest falling data pulse and set the strobe to the center of the sum of these two pulses. (see diagram)
5. Run operational tests on the reader and make any fine tuning adjustments which are necessary.

COMPANY CONFIDENTIAL

DATA BIT

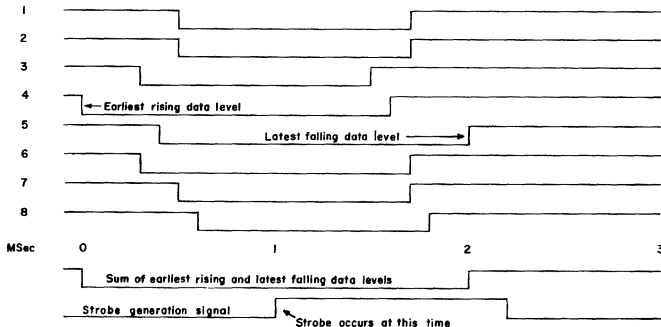

digital	FIELD SERVICE TECHNICAL MANUAL				Option or Designator
	12 Bit <input checked="" type="checkbox"/>	16 Bit <input checked="" type="checkbox"/>	18 Bit <input checked="" type="checkbox"/>	36 Bit <input checked="" type="checkbox"/>	PC04

Title				CIRCUIT SCHEMATIC FOR PC04 REGULATOR BOARD		Tech Tip Number		PC04-TT-2	
All		Processor Applicability		Author		David Nielsen		Rev 0	
X				Approval		Jeff Blundell		Date 02/08/73	
				Cross Reference					

The circuit schematic for the PC04 regulator board is not presently part of the customer print set, which can cause some difficulties if you are trying to repair a power problem. The drawing below reflects the latest revision of the supply (created by ECO 5408308-003), and shows the change of R1 and R4 to 82 ohms, the new zener D3, and the elimination of the 0.1 ohm resistor (replaced by an external fuse) in the bridge circuit.

Peripheral Engineering is aware of the documentation shortcomings, and have been asked to add the schematic to the drawing set.

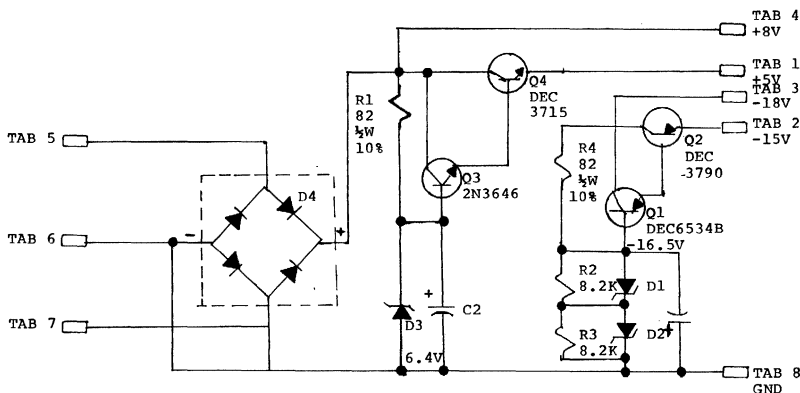

UNLESS OTHERWISE INDICATED: Capacitors are 6.8 MFD 35V 20%
 Diodes are 1N756A, 8.2V
 D4 is MDA960-3
 Resistors are 1/4W 5%
 Tabs are AMP 41290

COMPANY CONFIDENTIAL

Title						Tech Tip	
ROYTRON PUNCH IMPROVEMENTS						Number PC04-TT-3	
All	Processor Applicability					Author	Rev
						RFG BURGESS	0
					Approval	Date	Cross Reference
					JIM BARCLAY	3/15/74	

Older models of the Roytron punch in heavy duty applications are consuming punch pins and index pins at a high rate with resultant increase in Field Service expenditure. More recent punches in similar applications do not appear to have this problem.

Roytron has introduced the following changes to overcome some of the earlier problems.

1. A higher chad bubble, Roytron part number 801048, has been introduced to alleviate the problem of chad backing up and generally over-loading the whole punch mechanism. Future improvements to this part may include an aluminum flashing inside the chad bubble to bleed off static built up on the chad and springs under the heads of the hold down bolts to allow the bubble to lift if chad build up still occurs.
2. Punch pins have been changed from a hollow ground type of end to a diagonally flat ground end, the part number change is from 160110571 to 551252.
3. The index pin has been similarly changed but its part number is still 160110563.

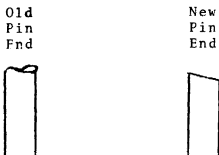

The DEC part number will not change.

(Page 4 intentionally left blank)

PAGE 464	PAGE REVISION 0	PUBLICATION DATE March, 1974
----------	-----------------	------------------------------

digital	FIELD SERVICE TECHNICAL MANUAL				Option or Designator
	12 Bit <input checked="" type="checkbox"/>	16 Bit <input type="checkbox"/>	18 Bit <input type="checkbox"/>	36 Bit <input type="checkbox"/>	PC8E

Title				CONVERTING PC8E, PC8I, PC8L		Tech Tip		Number		PC8E - TT-1		
All		Processor Applicability			Author		Rev		Date		Cross Reference	
BE	8I	8L			W. Freeman		0					
					W. E. Cummins							

Customers desiring to remove their high speed reader/punch from PDP-8I to use on their PDP-8E must do the following:

- 1) Purchase an M840 (the high speed reader/punch board that plugs into the omnibus). - Price \$750 - cable(s) included.
- 2) Have Field Service convert the reader/punch combination (PC04).

The Field Service charge is as follows:

Reader/punch	-	\$735.
Reader alone	-	505.
Punch alone	-	325.

The above Field Service prices do not include travel.

The Field Service conversion procedure is as follows:

To convert a PC8I to a PC8E:

Parts required:

Part Number	Name	Quantity
M840 with cable	PC Control	1
M044	Solenoid Drivers	3
70-06268-1	Wired logic	1
*70-07267	Photo Array	1
*G918D	Photo Amplifier	1

* Not required if ECO #PC04-00046 is installed.

Follow these instructions:

- 1) Remove front cover and cage.
- 2) Check the PC04 for its ECO status.
 - A) Are the reader motor drive resistors 25 ohms 40 watts? If not, install ECO #PC04-00022.
 - B) Is the +5VDC off by more than +.5V? If so, install ECO's #5408308-00003 and 4.
 - C) Is the feed switch causing the motor to stall? If so, install ECO's #5408310-0000 1 and 2 and PC04-00025.
- 3) Remove old photo cell array and shim. (Dispose of shim.)
- 4) Unsolder or unwrap wires listed in Table A.

Note: Do not cut off anymore wire than necessary.

COMPANY CONFIDENTIAL

Title CONVERTING PC&E, PC&I, PC&I						Tech Tip Number PC&E-TT-1		
All Processor Applicability						Author W. Freeman Rev #		Cross Reference
BE	8I	8L				Approval W. E. Cummins Date 11/14/73		

- 5) Remove old wire logic.
- 6) Place new wired logic in PC04.
- 7) Replace wires that were removed in step 4.
- 8) Install modules in the wired logic, using the PC04 UML (PC04-0-3 Rev. B).
- 9) To "Set up" the reader use the PC04/PC05 (Feed Hole Strobe) Maintenance Manual, chapter 5.3.
- 10) Replace the front cover and cage.
- 11) Perform the customer acceptance procedure.
- 12) Make the log entry.

TABLE A

Wire #	Logic Conn.	Color	
10	B06V*	Green	
18	A08A	Gray-Red	
19	A08B	Gray-Yellow	
20	B02U	White	Punch
21	B08C	Black	Punch
22	A01V	Yellow	
23	B07A ^o	White-Black	
24	A08F	White-Yellow	
25	A02B**	Brown	
30	B03R	Brown	
31	B03S	Brown	
32	B04R	Orange	
34	B05R	Yellow	
35	B05S	Yellow	
36	B06R	Violet	
37	B06S	Violet	
52	B02D*	Blue	Punch

* If there isn't any wire on B02D and the wire on B06B is blue ECO #PC04-00022 must be installed.

** If ECO #PC04-00046 hasn't been installed the wire on AD2B is on A02N and should be moved to A02B when installing new logic block.

^o If white-black wire is on B07C instead of B07A, ECO #PC04-00025 should be installed.

COMPANY CONFIDENTIAL

digital	FIELD SERVICE TECHNICAL MANUAL				Option or Designator
	12 Bit <input checked="" type="checkbox"/>	16 Bit <input type="checkbox"/>	18 Bit <input type="checkbox"/>	36 Bit <input type="checkbox"/>	PC8E to PC8I

Title CONVERTING PC8E, PC8I, PC8L				Tech Tip Number PC8E-TT-1	
All Processor Applicability			Author W. Freeman	Rev 0	Cross Reference
8E	8I	8L	Approval W.E.Cummins	Date 11/14/73	

Customers desiring to remove their high speed reader/punch from the PDP-8/L to use on their PDP-8/E, must do the following:

Purchase an M840 (the high speed reader/punch control board that plugs into the OMNIBUS).

Price - \$750. cable(s) included.

Have Field Service modify the PC04 using ECO #46.

The Field Service charge is as follows:

To convert the reader/punch combination (PC04)

The reader/punch - \$545.

The reader alone - \$385.

The punch alone - \$160.

The above Field Service prices do not include travel.

To convert PP8I to PP8E:

Parts required:

- 1 - M840
- 3 - M044
- 1 - 70-06268-1

Skip steps 2A, 2C, 3 and 9 of PC8I to PC8E conversion.

To convert PR8I to PR8E:

Parts required:

- 1 - M840
- 1 - *G918D
- 1 - 70-06268-1
- 1 - *70-07267

* Not required if ECO PC04-00046 is installed.

Conversion procedure same as "PC8I to PC8E".

COMPANY CONFIDENTIAL

Title				PC8I INSTALLATION PROCEDURE				Tech Tip Number		PC8I-TT-1	
All		Processor Applicability		Author		Art Newbery		Rev		0	
		8I		Approval		Bill Cummins		Date		07/31/72	
								Cross Reference			

Refer to print D MU 8I 0-17 for placement of modules and cables. The 779 power supply is mounted at the rear of the 8I cabinet just above the track for the 8I logic with 9, 10/32 screws. AC power from the 704A supply is brought to terminals 1 and 2 on the lower transformer in the 779. Output from this transformer is brought to the power channel at the top of the cabinet. To obtain 30 volts for the reader motor, the outputs of -15 and +15 in the upper portion of the 779 are brought directly to the reader motor with +15 used as a ground reference. (see diagram below) The reader light is supplied with +10 volts from the power channel.

For neatness, all wires are spiral wrapped together and tied to the cabinet frame. Be certain to leave enough slack so that when the PC8I is pulled out to the end of the tracks, no strain is imposed on these power lines, the AC power cord, or the flexprint cables. A 6/32 machine screw and nut are used with a 1/4" cable clamp to tie down the power cable at the rear on the reader side of the PC8I pan. The AC cord from the power channel to the PC8I is tied down with the power wires from the 779 and other leads from the power channel but is not spiral wrapped with them.

Arthur Newbery April 1969

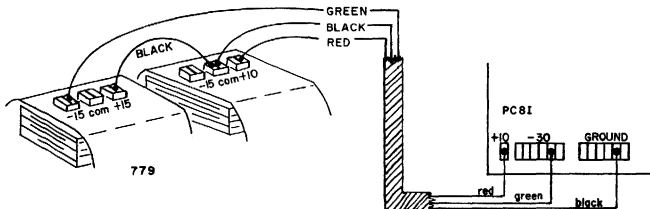

COMPANY CONFIDENTIAL

PAGE	468	PAGE REVISION	0	PUBLICATION DATE	July 1972
------	-----	---------------	---	------------------	-----------

digital	FIELD SERVICE TECHNICAL MANUAL				Option or Designator
	12 Bit <input checked="" type="checkbox"/>	16 Bit <input type="checkbox"/>	18 Bit <input type="checkbox"/>	36 Bit <input type="checkbox"/>	PC8I to PDP8

Title						Tech Tip	
CONVERTING PC8E, PC8I, PC8L						Number PC8I TT#2	
All	Processor Applicability			Author	W. Freeman	Rev	Ø
				Approval	W. E. Cummins	Date	11/14/73
						Cross Reference	
						PC8E TT#1	

Title						Tech Tip	
CONVERTING PC8E, PC8I, PC8L						Number PC8L TT#1	
All	Processor Applicability			Author	W. Freeman	Rev	Ø
				Approval	W. E. Cummins	Date	11/14/73
						Cross Reference	
						PC8E TT#1	

Title WIRE RUNS FOR POWER SUPPLIES AND CONTROL				Tech Tip Number PDP 8-TT-1	
All		Processor Applicability		Author C. Sweeney	Rev g
8				Approval W. Cummins	Date 07/31/72
Cross Reference					

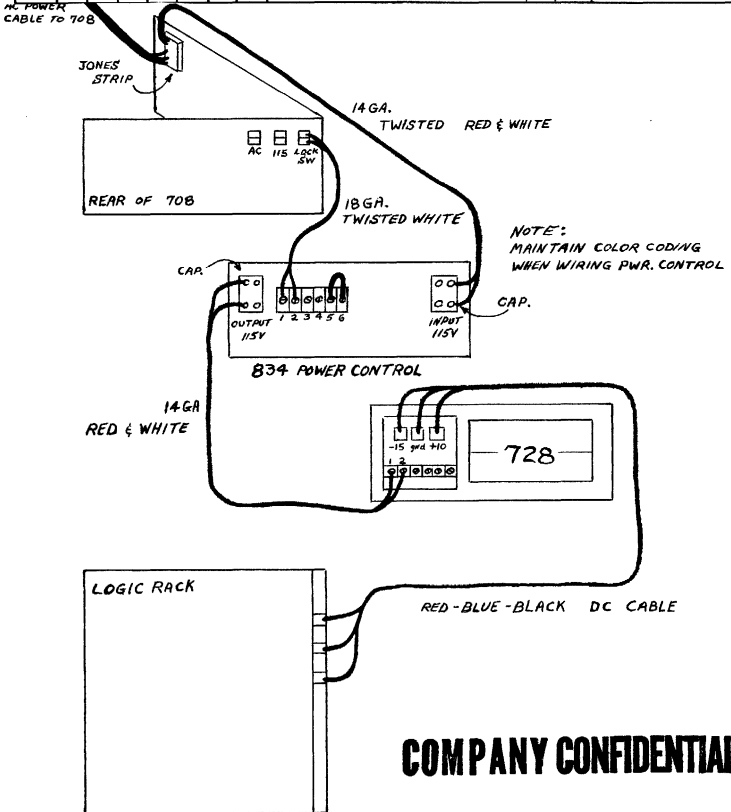

COMPANY CONFIDENTIAL

Title WIRE RUNS FOR POWER SUPPLIES AND CONTROL (Con't.)				Tech Tip Number PDP8-TT-1	
All Processor Applicability		Author C. Sweeney	Rev 0	Cross Reference	
8		Approval W. Cummins	Date 07/31/72		

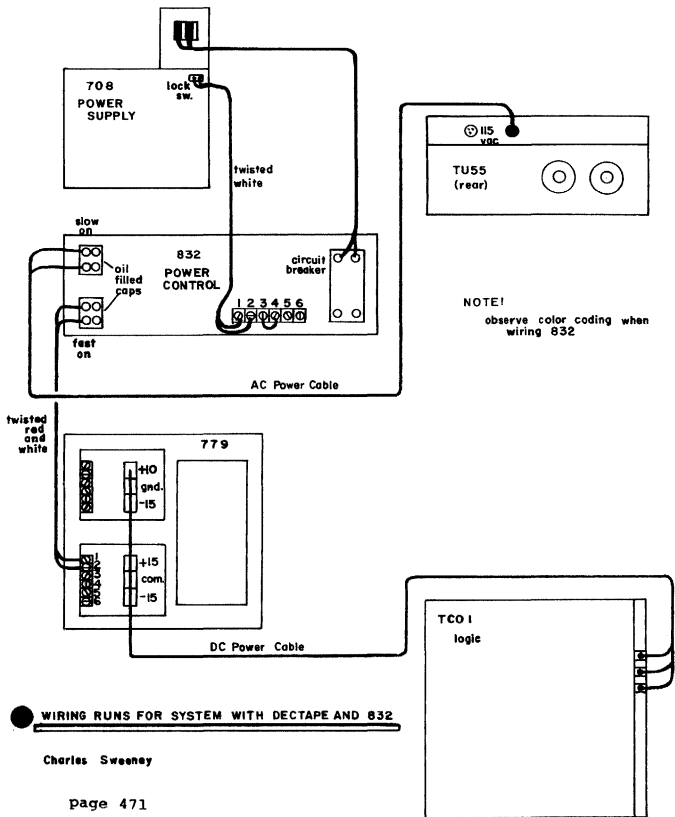

WIRING RUNS FOR SYSTEM WITH DECTAPE AND 832

Charles Sweeney

Title PDP 8 INTERRUPT PROBLEM						Tech Tip Number PDP8-TT-2		
All	Processor Applicability					Author W. Freeman	Rev 0	Cross Reference
	8					Approval W. Cummins	Date 11/15/73	

PROBLEM

If the interrupt request line is asserted at just the proper time in the PDP-8's cycle, the INT ACK flip flop's "1" output may be negative about 100 nanoseconds at T2B time. The flip flop does not really set, it starts to, but its DCD gate is not fully enabled. The interrupt system still operates properly, the PDP-8 merely does not honor the request until the next Fetch cycle. At that time INT ACK's DCD gate has had lots of time to set up.

INT ACK(1) is used as one of the inputs to a diode gate which forces IR₀ to a 1. If INT ACK(1) goes negative, the 0 output of IR₀ will be held at ground. Because of the way in which the DCD gate is tied back to the flip flop output, the DCD gate on IR₀ will not start setting up until IR₀'s 0 terminal is allowed to go negative. Hence, if INT ACK "glitches" for 100 nsec, the DCD gate on IR₀ will have 100 nsec less time to set up. Just think of what could happen if the instruction happens to be an Operate, and IR₀ fails to set!

This problem is particularly noticeable in the 680 system since it uses the interrupt almost continually.

SOLUTION

Connect 0 → IR signal into the unused input of the diode gate (PB200 to PD35R). The diode gate will thus be disabled for 150 nsec at the beginning of each Fetch cycle, and IR₀ will have its full time to set up.

COMPANY CONFIDENTIAL

Title DW08 or PDP8						Tech Tip Number PDP8-TT-3		
All	Processor Applicability					Author W. Freeman	Rev 0	Cross Reference
	8					Approval W. Cummins	Date 11/15/73	

Problem: DW08 outputs for IOP's, T1 and T2, and PWR CLR, are passing extra pulses for the positive excursions which occur on the inputs to M508; i.e., positive overshoot from W640 on the IOP's.

Solution: Problem caused by long positive excursions on BT1 and BT2 pulses. During these positive periods, any other positive spike at another input on the M508 would produce an output. Apparently a positive excursion of >1 micro sec will raise the -.7 volt clamp on the M508 to some positive level, thus disabling the positive clipping diodes on all other inputs and allowing a positive spike to produce an output.

A termination of 47 ohms on all six W640 outputs cured the problem.

PAGE 472	PAGE REVISION 0	PUBLICATION DATE May 1974
----------	-----------------	---------------------------

digital	FIELD SERVICE TECHNICAL MANUAL				Option or Designator
	12 Bit <input checked="" type="checkbox"/>	16 Bit <input type="checkbox"/>	18 Bit <input type="checkbox"/>	36 Bit <input type="checkbox"/>	PDP8
Title R650/PDP8 MEMORY PROBLEM					Tech Tip Number PDP8-TT-4
All	Processor Applicability		Author D. A. White	Rev <i>g</i>	Cross Reference
8			Approval Bill Freeman	Date 12/05/73	

PROBLEM: PDP-8 MEMORY: R650 Driving Read Level to G209's saturates. This is a PRF problem which may show up as poor margins in extended memory tests, or as a problem in using keys when memory is tuned for good checkerboard margins.

SOLUTION: R650 E or later: change the 4-320 ohm resistors to 470 ohm 1/4W 10%. This problem does not exist in D or earlier revisions. Incidentally, revision "S1A" is later than "E". All boards which must be changed have TO-5 can transistors (2N2219's) in them. Watch out--there are 82 ohm resistors in other places on the board.

ACTION: Fix "E" or later revision, all machines. The only module locations affected are MC 16 and EMC 16. (By the way, this fix could also help MB Bits when the machine has lots of I/O gear.)

COMPANY CONFIDENTIAL

Title PDP8 GLASS FRONT PANELS						Tech Tip Number PDP8-TT-5		
All	Processor Applicability					Author P. Dudziak	Rev g	Cross Reference
	8					Approval Don Herbener	Date 2/28/74	

Several requests for the part number of PDP-8 Front Panels have come into the Technical Assistance Center. For future reference, the correct part numbers are listed below:

19½" Table Top Model - 74-4534

19" Cabinet Model - 74-4883

Title FRONT PANEL SWITCHES						Tech Tip Number PDP8-TT-6		
All	Processor Applicability					Author D. Staube	Rev 0	Cross Reference
	8					Approval J. Blundell	Date 4-1-74	

12-5064 Switch with spring
12-5411 Switch without spring

Title MARGINAL CHECK PANEL ASSEMBLIES						Tech Tip Number PDP8-TT-7		
All	Processor Applicability					Author Jeff Blundell	Rev 0	Cross Reference
	8					Approval Bill Freeman	Date 4/2/74	

The part numbers for the Marginal Check Panel Assemblies are:

74-04604 Processor Wing
74-04606 Memory Wing
12-05086 Marginal Check Switch

digital	FIELD SERVICE TECHNICAL MANUAL				Option or Designator PDP-8/E
	12 Bit <input checked="" type="checkbox"/>	16 Bit <input type="checkbox"/>	18 Bit <input type="checkbox"/>	36 Bit <input type="checkbox"/>	

Title PDP-8/E I/O Termination Rules				Tech Tip PDP-8/E TT-1 Number		
All	Processor Applicability			Author Ken Quinn	Rev β	Cross Reference
	8E			Approval W.E. Cummins	Date 07/31/72	

Due to the fast switching time of the AC bits in the PDP-8/E, sufficient noise may be generated along the Buffered AC cable (of the Positive I/O Interface) to cause false signals at the peripheral end.

All PDP-8/E's which have a Positive I/O Interface must be equipped with a G717 Rev. A or B. If a G717 Rev. A is used, a $1\text{k}\Omega$ OHM resistor must be installed on the Initialize Signal to ground. If the use of G717 is not possible, (i.e., customer interface) terminate the following signals with $1\text{k}\Omega$ OHM resistors to ground.

Signals: BIOP 1
BIOP 2
BIOP 4
BTS 1
BTS 3
Initialize

Title W103/PDP-8/E Problems with Negative Logic				Tech Tip PDP-8/E TT-2 Number		
All	Processor Applicability			Author Louis Klotz	Rev β	Cross Reference
	8E			Approval W.E. Cummins	Date 07/31/72	

The W103 device selector for negative logic is commonly used on PDP-8's, 8I's, 8L's; however, it presents a problem to the 8E. The IOP width on a PDP-8/E is nominally 56 nsec. and variable upwards to 3.1 usec. All data, skips, etc., being strobed during the last $1\text{ k}\Omega$ nsec. of width. The W103 triggers a $4\text{ k}\Omega$ nsec. PA, and uses it to gate information onto the I/O bus; therefore, the data has come and gone before strobe time. A new device selector (W123) will soon be released which corrects this problem. It consists of the W103 etch with the PA omitted. In the meantime the W103 can be modified to eliminate this problem.

Delete: C1 $82\text{ k}\Omega$ pf. cap.
C4 $82\text{ k}\Omega$
C7 $82\text{ k}\Omega$
D28 D664
D46 D664
D54 D664

COMPANY CONFIDENTIAL

Replace with jumper:

C2 33 μ pf cap
C5 33 μ
C8 33 μ

Mark the handle to denote the module is now a W123.

These boards should work on any family of 8 machine, so no compatibility problem should exist.

The W123 may also solve timing problems on positive-but PDP-8I's.

Title PDP-8/E I/O and Break Cables Pin Chart						Tech Tip Number		PDP-8/E TT-3		
All	Processor Applicability					Author Jack Cuddy		Rev	β	Cross Reference
	8E					Approval W.E. Cummins	Date 07/31/72			

The cable pin chart on page 9-29 of the PDP-8e SMALL COMPUTER HANDBOOK is in serious error.

Any attempt to follow the chart in the PDP-8e SMALL COMPUTER HANDBOOK will result in total confusion.

The pin numbers given below for the H855 (BERG/3M) connectors are given as though you were looking directly at the cable connector, not the socket on the 8e module. Pin A is the top-right pin, pin B is the top-left pin,, pin UU is the lower-right pin, and pin VV is the lower-left pin. The H855 connectors are 40 pin connectors.

The following information is valid for the I/O and break cables; it should also be correct for any other 8E device utilizing type BC08J cables.

COMPANY CONFIDENTIAL

	<u>H855</u>	<u>M953</u>	<u>H855</u>	<u>M953</u>
A	A1-gnd	A1-gnd	Y	K1-gnd
B	A1-gnd	A1-gnd	A	M2
C	A1-gnd	A1-gnd	AA	K1-gnd
D	B1	B1	BB	L1
E	A1-gnd	A1-gnd	CC	N1-gnd
F	D2	D2	DD	P2
H	F2-gnd	F2-gnd	EE	N2-gnd
J	D1	D1	FF	M1
K	F2-gnd	F2-gnd	HH	R1-gnd
L	E2	E2	JJ	S2
M	J2-gnd	J2-gnd	KK	R1-gnd
N	E1	E1	LL	P1
P	C1-gnd	C1-gnd	MM	R1-gnd
R	H2	H2	NN	T2
S	C1-gnd	C1-gnd	PP	R2-gnd
T	H1	H1	RR	S1
U	F1-gnd	F1-gnd	SS	T1-gnd
V	K2	K2	TT	V2
W	L2-gnd	L2-gnd	UU	U2-gnd
X	J1	J1	VV	U2-gnd

NOTE: Pins A2, B2, U1, and V1 on the M953 have no connections.

digital	FIELD SERVICE TECHNICAL MANUAL				Option or Designator
	12 Bit <input checked="" type="checkbox"/>	16 Bit <input type="checkbox"/>	18 Bit <input type="checkbox"/>	36 Bit <input type="checkbox"/>	PDP8-E

Title				FIELD RETROFITTING 8E MODULES		Tech Tip Number		PDP8E-TT-4	
All	Processor Applicability			Author	K. Quinn		Rev	0	
	8E			Approval	W. Cummins		Date	07/31/72	
								Cross Reference	

8E modules must be updated to show revision status after rework.

The status of a module is defined by two (2) revision levels:

- The etched board revision level
- The circuit schematic revision level

The etched board level is imprinted during production and permanently identified the module board.

The CS level at which the module shipped is imprinted on the handle of the module.

The CS level is subject to change when an ECO orders reworking. There is a column of characters, "A" through "V" on the etched field installed ECO. As each ECO is installed in the field and the CS revision level changes, one or more of these characters is to be removed from the column. The first character of those remaining will indicate the actual CS revision level of that board.

Exact instructions for CS level updating of the module following implementation of an 8E module ECO will accompany the ECO.

NOTE: Early revision 8E modules do not have CS revision letters etched on the board. In such cases, after field installing an ECO, one should scratch the new CS revision into the soft plastic handle using a knife, exacto pen or some other such sharp tool.

COMPANY CONFIDENTIAL

Title EDGE CONNECTOR (H851) MISALIGNMENT				Tech Tip PDP-8/E TT-5		
Processor Applicability				Author Bill Moroney	Rev 0	Cross Reference
All	8E			Approval W.E. Cummins	Date 07/31/72	

EDGE CONNECTOR (H851) MISALIGNMENT

On some of the old, double molded block, H851 connectors an alignment problem in manufacturing existed. Manufacturing now uses a single-molded block with two entry rows. The alignment problem no longer exists. Misalignment sometimes caused the H851 pins to push through the foam and short to the 8E cover.

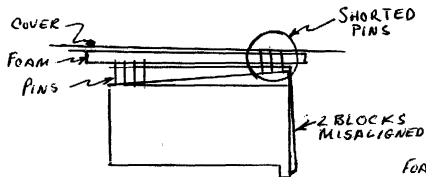

Old 2 Block H851

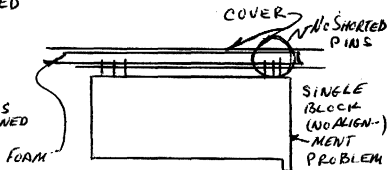

New Single Molded Block H851

In the event of this problem in the field, new H851's can be obtained from Maynard stock. Reference this tech tip and ask for the new single molded block type.

COMPANY CONFIDENTIAL

digital	FIELD SERVICE TECHNICAL MANUAL				Option or Designator
	12 Bit <input checked="" type="checkbox"/>	16 Bit <input type="checkbox"/>	18 Bit <input type="checkbox"/>	36 Bit <input type="checkbox"/>	PDP-8E

Title CABLINE RULES FOR I/O AND BREAK CABLES				Tech Tip Number PDP8E-TT-6		
All	Processor Applicability			Author Klotz/Moroney	Rev 0	Cross Reference
	SE			Approval B. Cummins	Date	

The BC08J cable (flat gray cable used with M835 and M8360) has a characteristic impedance of 75 ± 7 ohms, DEC #74-5556 cable (coax) is approximately 95 ohms while DEC #BC08A cable (Mylar) is 90-125 ohms. Therefore in cabling a PDP-8E system if mylar is used an impedance mismatch occurs which cannot be tolerated by peripherals.

As a result mylar cannot be used in PDP-8E Systems.

Cabline rules should be as follows:

- 1) Round and flat coaxial cables are electrically interchangeable and may be intermixed in a system. If cables will be subjected to extra ordinary abuse (such as Free Stand Cabinets) round coax is preferred.
- 2) Mylar may not be used.
- 3) Not more than one change from gray cable (BC08J) to coax or coax to gray cable should be made over the length of a bus.
- 4) The following cable length restrictions must be observed:

Cables	Directed to Peripheral	Through DW08A
I/O	50 ft max.	40 ft. max.
Break	30 ft max.	20 ft. max.

COMPANY CONFIDENTIAL

Title PDP8E BOUNCE IN CONSOLE KEYS					Tech Tip Number PDP8E-TT-7		
All	Processor Applicability				Author Jeff Blundell	Rev 0	Cross Reference
	8E				Approval Frank Purcell	Date 07/31/72	

Problem: Bounce in console keys. Examine and deposit may double step. Continue may step over halts when starting test programs.

Cause: Some front panels may have reached the field with the wrong capacitor in the switch filter circuit.

Check: C13 should be 39 MFD, bad boards have 6.8 MFD installed. C13 is located on the right of the board (as seen from the front) between the five (5) transistors and E10 (DEC 7404) just above the aluminum supporting strip with the lamp holes in it.

The correct capacitor has DEC part number 10000076.

The following program may be of use when investigating this type of problem. It will cycle the teletype once each time continue is pressed, and halt with the number of bounces in the AC. If the switch bounces for longer than 85ms, more than one printer cycle will take place. Starting Address is 3.

	0/	7402	Normal Halt. Number of bounces in AC
	1/	6041	Flag Set?
	2/	5006	No, Error, Add one to AC
Start	3/	7200	Yes, No Bounce
	4/	6046	Set Flag in 85 ms
	5/	5000	Jump to Halt to wait for bounce
	6/	7001	Add one to AC
	7/	5000	Jump back to Halt to wait for bounce

COMPANY CONFIDENTIAL

digital	FIELD SERVICE TECHNICAL MANUAL				Option or Designator
	12 Bit <input checked="" type="checkbox"/>	16 Bit <input type="checkbox"/>	18 Bit <input type="checkbox"/>	36 Bit <input type="checkbox"/>	PDP8E

Title PDP8E MODULE COMPATIBILITY LIST				Tech Tip Number	PDP8E-TT-8
All	Processor Applicability		Author Don Herbener	Rev 0	Cross Reference
8E			Approval Frank Purcell	Date 07/31/72	

The following is the latest list of modules and revisions which must be used together. This list of modules will be particularly usefull in conjunction with the modules swapping scheme and also to check on status of a machine before options are added.

COMPATIBILITY LIST

H724 Power Supply:

A2 regulator board must be Rev. H. to work with expander box.

ECO to replace this are #5409262-6 and 7.

54-9057 KC8E-B Front Panel:

ECO #3 CS Rev. E, etch Rev. F must be used with EAE (M8340 and M8341) and timing board (M8330).

M8310 KK8E Register Control

ECO #6 CS Rev. E, etch Rev. E when used with EAE (M8340 and M8341) and a long bus.

M8320 KK8E Bus Loads:

ECO #1 CS Rev. B, etch Rev. B when used with M8330.

M8326 DB8E-A Interprocessor Buffer

ECO #3 (M8326 CS Rev. E etch Rev. E if customer wants done flip-flop.

M8330 KK8E Timing Board:

ECO #4 M848 (Power Fail) CS Rev. F, etch Rev. D

M847 must have M8330 to run (remove M833)

ECO #I-M8320 must be CS Rev. B, etch Rev. B

M8330 must use M8350 and M8360 to operate KA or KD

COMPANY CONFIDENTIAL

Title					Tech Tip Number		
PDP8E MODULE COMPATIBILITY LIST (Continued)					PDP8E-TT-8		
All		Processor Applicability			Author	Rev	Cross Reference
	SE			Don Herbener	0		
				Approval Frank Purcell	Date	07/31/72	

M8340 KE8E EAE:

ECO #3 for 54-9057 (Front Panel) CS Rev. E, etch Rev. F

ECO #6 for M8310 (Reg. Control) CS Rev. E, etch Rev. F

ECO #1 for M8830 (Real Time Clock) CS Rev. B, etch Rev. C with M8340 etch Rev. F

EAE should use M8330 Timing Board

M8341 KE8E EAE:

ECO #3 54-9057 (Front Panel) CS Rev. E, etch Rev. F

EAE must use M8330 (Remove M833)

M8350 KA8E I/O Interface:

M835 do not use on customer interface replace with M8350

M8350 must be used in a machine that has an M8330

M8360 KD8E Data Break Interface:

M8360 must be used in machines that have M8330

M837 KM8E Memory Ex. Control:

ECO #2 CS Rev. D, etch Rev. D when used with power fail (KP8E M848)

M840 PC8E High Speed Reader:

ECO #8 CS Rev. K, etch Rev. J with power supply regulator board Rev. F and expander box.

M847 MI8E Bootstrap Loader:

ECO #5 for 54-9057 (Front Panel) CS Rev. F, etch Rev. F must have M8330 to operate not M833.

M848 KP8E Power Fail:

ECO #2 M837 CS Rev. D, etch Rev. D

ECO #4 CS Rev. F, etch Rev. D when used with M8330

M8830 DK8E-C Real Time Clock:

ECO #1 CS Rev. B, etch Rev. C with EAE M8340 Rev.F

digital	FIELD SERVICE TECHNICAL MANUAL				Option or Designator
	12 Bit <input type="checkbox"/>	16 Bit <input type="checkbox"/>	18 Bit <input type="checkbox"/>	36 Bit <input type="checkbox"/>	PDP8E

Title PDP8E/M/F POWER SUPPLY OVERLOADING				Tech Tip Number PDP8E-TT-9		
All	Processor Applicability			Author Chris Norris	Rev B	Cross Reference
	<input type="checkbox"/> 8E	<input type="checkbox"/> 8M	<input type="checkbox"/> 8F	Approval E. Purcell	Date 1/9/74	

It is possible on an 8E system with a dual omnibus to overload the power supply. The +5 volt line has a 25 amp fuse; however, the specification on the +5 volt line is only 20 amps.

The PDP-8M power supply is a switching regulator supply rather than a linear regulator supply like that of the PDP-8E. This switching regulator is capable of a power supply output of 175 watts shared between -15vdc and +5vdc. In calculating current drain in configuring systems, you should consider both voltages together for an accurate picture of loading on this supply.

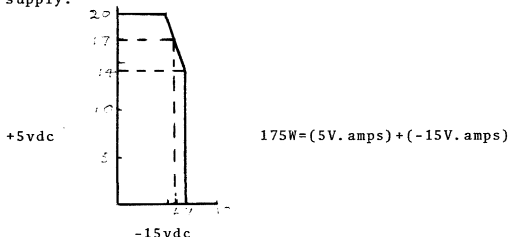

Example (a): 17A at +5 leaves 6A at -15 (Total +5-15 watts=17X5+6X15=175)
 Example (b): 7A at -15 leaves 14A at +5 (Total +5-15 watts=7X15+14X5=175)

It can be seen that +5vdc can actually exceed 17 amps in some configurations and go as high as 20 amps without exceeding the power supply limits.

Absolute Max - 15v load = 7 amps
Absolute Max +5v load = 20 amps
 Recommended maximum +5v load is 17 amps.

The following chart indicates current consumption. You may actually draw more under severe programming conditions (such as time-share applications). If you have a system that approaches maximum current draw, a meter should be used to measure the actual current consumption.

The following is only intended as a guide and any system under question should be measured to find out actual current draw.

Title PDP 8E/M/F POWER SUPPLY OVERLOADING						Tech Tip Number PDP8E-TT9	
All Processor Applicability						Author Chris Norris	Rev B
8E	8M	8F				Approval F. Purcell	Date 1/9/74
						Cross Reference	

Option & Module #	Steady State Current +5V	Operating Current+5V	Oper. Current			
			Steady State-15V	-15V	+15V	Other
AD8-EA A841 A231	.175A .790A	.205A .800A	NA NA	NA NA		
AH8-EA A231	.031A	.033A	NA	NA		
DK8-EA M881	.335A	.335A	NA	NA		
DK8-ED M512	.60A					
DK8-ED M860	.84A					
DK8-EP M860 M518	.810A .615A	.810A .615A	.013A .052A			
DP8-EA M839 M866	1.8A		.105A		.050A	
DR8-E M863	.830A	2.25A	NA	NA		
KA8-E M8350	1.4A	1.4A	NA	NA		
KC8-E 5409668						
KD8-E M8360	1.2A	1.2A	NA	NA		
KE8-E M8340 M8341	.835 .750A		NA NA	NA NA		
KG8-E M884	.800A	.931A	NA	NA		

COMPANY CONFIDENTIAL

digital	FIELD SERVICE TECHNICAL MANUAL				Option or Designator
	12 Bit <input checked="" type="checkbox"/>	16 Bit <input type="checkbox"/>	18 Bit <input type="checkbox"/>	36 Bit <input type="checkbox"/>	PDP8E

Title PDP8E/M/F POWER SUPPLY OVERLOADING			Tech Tip Number PDP8E-TT-9		
All Processor Applicability			Author Chris Norris		Rev B
			Approval F.Purcell		Date 1/9/74
			Cross Reference		

Option & Module#	Steady State Current +5V	Operating Current+5V	Steady State-15V	Oper.Current -15V	+15V	Other
KK8-E						
M8300	1.5A	1.65A	NA	NA		
M8310	.57A	.6A	NA	NA		
M8330	1.2A	1.2A	NA	NA		
M8320	.46A	.97A	.97A	.16A	.525A	
KL8-E						
M8650	.800A	.800A	.013A	.013A	.065A	
KP8-E						
M848	.280A	.280A		.040A		28v AC CT@20ma
LC8E	.40	.40				
M8329	.					
LE8-XX						
M841	.350A	.350A	NA	NA		
LS8E	.40	.40				
M8342						
MC8E						
M837	.985A		NA	NA		
MI8-E						
M847	.71A	.71A	.27A	.27A		
MM8-E						
G104	1.02A	2.2A	.24A	3.3A		Only 4K of mem in an ext mem system will be at operating current. The remainder will be at steady state.
G227						
H220						
MM8EJ						
M212						
G233						
G111	1.6	2.3	.37	3.3		

COMPANY CONFIDENTIAL

Title					Tech Tip		
PDP8E/M/F POWER SUPPLY OVERLOADING					Number PDP8E-TT-9		
All	Processor Applicability				Author	Rev	Cross Reference
	8E	8M	8F		Chris Norris	B	
					Approval	Date	
					Frank Purcell	1/9/74	

Option & Module#	Steady State Current+5V	Operating Current+5V	Steady State-15V	Oper. Curr. -15V	+15V	Other
MP8E G105 G227 H220	1.02	2.2	.24	3.3		
MR8EC M880 H241	1.50	1.50				
MR8EA M861 G643	1.50	1.50				
MR8FB M8349	3.80	3.80	0.35	0.35		
PC8E M840	.745A	.840A		.045A		
RK8E M7104 M7105 M7106	3.10	3.10				
TA8E M8331	2.80	2.80				
TD8-E M868	.920A	1.25A	.076A			
XY8-E M842	.42A	.42A	.020A	.025A	.010A	
VC8-E M869	.310A	.310A	NA	NA		
VC8-E M885	.520A	.520A	.09A	.093A		

digital	FIELD SERVICE TECHNICAL MANUAL				Option or Designator
	12 Bit <input checked="" type="checkbox"/>	16 Bit <input type="checkbox"/>	18 Bit <input type="checkbox"/>	36 Bit <input type="checkbox"/>	PDP-8/E

Title +5 V ADJUSTMENT H724 POWER SUPPLY				Tech Tip Number PDP8/E-TT-10		
All	Processor Applicability			Author Jeff Blundell	Rev 0	Cross Reference
	8E			Approval F. Purcell	Date 09/14/72	

PDP-8E Maintenance Manual, Vol. I, Figure 4-7 depicts pots on power control board A2 as follows:

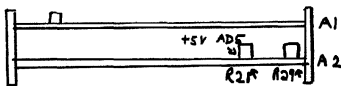

This is true on early revisions of A2 control board, but recent revisions are constructed as follows:

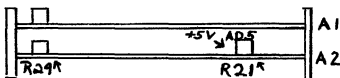

This can lead to confusion and blown fuses in overvoltage protection circuit (R29) when using diagram in Maintenance Manual as a guide when adjusting +5V.

Customers who have purchased spare parts kits may have received drawings with the kit showing the older layout, it would be a valuable point to check next service call.

A revised Vol. I will be printed around October 72, and the drawing will be updated in the new manual.

Title MM8-e OMNIBUS LOCATION				Tech Tip Number PDP8E-TT-11		
All	Processor Applicability			Author Mel Arsenaault	Rev 0	Cross Reference
	8E			Approval W. Cummins	Date 07/27/72	

When a PDP8/E has more than 1 omnibus, the memories should always be located no further back than slot 28 as long as this agrees with the priority listing. When a machine is fully loaded and the memories are located in locations higher than slot 28, the system should always be run with the cover on to insure proper air circulation. For checkout purposes, an external fan should be used when the cover is off.

COMPANY CONFIDENTIAL

Title CONFIGURING SYSTEMS						Tech Tip Number PDP8/E-TT-12		
All	Processor Applicability					Author Jeff Blundell	Rev 0	Cross Reference
	8E	8M	8F			Approval Frank Purcell	Date 12/01/72	

Publications do exist for all our customer families giving sizes, weights, power consumption, heat production, number of power cables, etc, but it seems that the PDP8 publications are not known about in the field.

You will find brochure 0804X.0672.2263 (available from communications services in Parker Street, Maynard) will answer many of the questions on power, heat, weight, size, humidity, etc that you may get asked.

Another publication, "Computer Site Preparation Handbook" (DEC-00-ICSPA-A-D) serves as not only an excellent guide to the first time computer customer worried about site preparation, but also has a convenient summary of Data Communications Equipment.

If you find any errors or omissions in either of these publications, please write a problem report on what you have found, and send it to your Support Group for forwarding to Maynard. They will be compiled and your inputs entered until we have a complete and correct reference.

Title #8310 MANUFACTURING DEFECT						Tech Tip Number PDP8E-TT-13		
All	Processor Applicability					Author Peter Jones	Rev 0	Cross Reference
	8E					Approval W. Cummins	Date 03/08/73	

Title FRONT PANEL ECO'S						Tech Tip Number PDP8E-TT-14		
All	Processor Applicability					Author J. Blundell	Rev 0	Cross Reference
	*8E					Approval W. Cummins	Date 6/4/73	

It has been decided that a change to a regular type of mechanical switch (rather than the magnet/reed combination presently used) will be made on the 8E console board. ECO 5409057 - 0010 implements this change, and creates etch Rev. J. The boards can be easily recognized by the 8M style rotary switch, rather than the previous plastic one. Without dismantling the machine to look, a quick check is to see whether the status switch will continue clicking a full revolution. Old ones will, but new ones will not, they will come to a stop at the "State" and "Bus" positions.

The two switches travel a different number of degrees between detents (old switch was a 36 degrees/click, new switch is 30 degrees/click) so a new console panel (plexiglass) is also required. The new panel, created by ECO 7408244-03, can be recognized easily by looking at the "State" and "Bus" reference lines. (See drawing below) it will also be date coded later than 15 June 1973.

digital	FIELD SERVICE TECHNICAL MANUAL				Option or Designator
	12 Bit <input checked="" type="checkbox"/>	16 Bit <input type="checkbox"/>	18 Bit <input type="checkbox"/>	36 Bit <input type="checkbox"/>	PDP-8E

Title FRONT PANEL ECO's (cont.)					Tech Tip Number	PDP8E-TT-14
All Processor Applicability			Author J. Blundell	Rev 0	Cross Reference	
8E			Approval W. Cummins	Date 6/4/73		

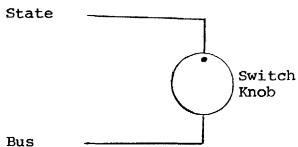

OLD

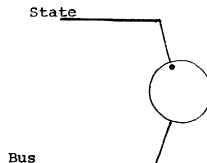

NEW

Note That these ECO's are not for field retrofit. They are manufacturing changes only, and the purpose of this tech tip is to warn the field of a possible logistic/compatibility problem as the newer panels start to appear from production.

Title Use of Module Extenders					Tech Tip Number	PDP-8E -TT-15
All Processor Applicability			Author C. Showers	Rev 0	Cross Reference	
8			Approval G. Chaisson	Date 6/19/73		

It has been noted that on several occasions destruction has been exhibited in 8E and 8M power supplies when using W900A (multilayer) module extender. When inserting the W900A in Row D of the omnibus, +5 is shorted to +15.

When working on 8 family omnibus machines it is required to use the W987 or W984 module extender.

The following is a list of module extenders and their uses:

W982 - single height, normal length extender.

W984 - double height and extended length extender. Two can be used in conjunction for omnibus use.

W987 - Quad height and extended length extender.

BC08M-OM Over the top flex print cable, connector, for use when one module is extended and other is in omnibus. For use when modules are connected by H851 connectors. Two are needed for omnibus use.

Note: In some cases two W984's can be used in place of the BC08M-OM. This can be done by turning the extenders upside down and placing the H-851's on the extender ends.

Title FRONT PANEL ROTARY SWITCH						Tech Tip Number PDP-8E-TT-16	
All Processor Applicability						Author Ralph Boehm Rev #	
8E						Approval G. Chaisson Date 8/17/73	
						Cross Reference	

Rotary switch pin 12-10129 is no longer being manufactured. This switch may be identified through the use of glass reeds and 360° rotation. If new switch is needed and if Logistics is depleted of pin 12-10129 then a new front panel will have to be installed.

Title MISSING ETCH ON REV. J. PROGRAMMERS CONSOLE						Tech Tip Number PDP-8E-TT-17	
All Processor Applicability						Author Larry Barbuto Rev #	
8E						Approval Jeff Blundell Date 20 Sept 73	
						Cross Reference	

Some Etch Rev. J. programmers front panel boards escaped into the field late July or August missing a piece of etch between D113 and R149.

This will cause an or of "Status" and "Bus" when you display "Bus".

As this was a temporary manufacturing problem, no ECO will be written to fix it, so you should examine recent systems next service call, and add a jumper if necessary.

This problem will not be widespread, since we are sure that less than 25 boards had this mistake.

Title OMNIBUS ORDERING INFORMATION						Tech Tip Number PDP8E-TT-18	
All Processor Applicability						Author J. Blundell Rev #	
8E 8M 8F						Approval F. Purcell Date 2/7/74	
						Cross Reference	

Confusion regarding the ordering of omnibusses through logistics will be avoided if the following points are remembered.

- 1.) The PDP8E omnibus is on H919. It is not a 70-6953 (ECO H919-001 killed this number in OCT. 1970), and references to it in the stock status report are being deleted.
- 2.) The PDP8M omnibus is an H919L. It may be recognized by the short harness to a mate-n-lok coming out of the front. It will work in a PDP8E without modification should the need arise.
- 3.) The H9190 is a wire wrappable panel the same size as an omnibus. It is used typically by customers who wish to implement some logic using regular M series (logic handbook) modules and mount the result inside the 8E chassis in place of the expander omnibus. No justification for stocking these in any quantity by F.S. exists, and the present stock level will be reduced to just one in Maynard.
- 4.) By calling out the omnibus by its H number, and the words "8E (or 8M) omnibus" no more H9190's should be received where they are not wanted.

digital	FIELD SERVICE TECHNICAL MANUAL				Option or Designator
	12 Bit <input checked="" type="checkbox"/>	16 Bit <input type="checkbox"/>	18 Bit <input type="checkbox"/>	36 Bit <input type="checkbox"/>	PDP8E

Title DMØ1 ON DWØ8/PDP-8E SYSTEMS				Tech Tip Number PDP8E-TT-19	
All Processor Applicability		Author R. Wilson	Rev 0	Cross Reference	
8E		Approval	Date 3-20-74	DMØ1-TT-5	

This Tech Tip is issued for cross reference purposes.

Title PDP8E DATA BREAK				Tech Tip Number PDP8E-TT-20	
All Processor Applicability		Author Ralph Boehm	Rev 0	Cross Reference	
8E	8F	8M	Approval G. Chaisson	Date 9/13/74	

PDP8E DATA BREAK

The KD8E (Data Break Module) **MUST** be set to a priority. If not, it will and has caused a number of intermittent and catastrophic failures and a \$14,000 law suit. The cost to Field Service and Product Support in at least 3 support calls that I know of, where the problem turned out to be the KD8E not being jumpered for a priority, has also been high.

The M8360 (KD8E) is factory wired with all the jumpers in A0 thru A11 and none in B0 thru B11, it cannot be put in the system this way. One of the jumpers in A0 thru A11 must be removed and placed in B0 thru B11. e.g. removing the jumper from A0 and placing it in B0 causes that particular KD8E to have the highest priority in the system.

Considerable Product Support Manpower has also been expended on problems resulting from two break devices having the same priority. This problem usually comes about with a Omnibus break option such as a TM8E or RK8E. The break priority on this type of option is controlled by jumpers in the option itself and if there are any KD8E's in the system they cannot be set to the same priority.

The Break Priority of a device is directly related to that devices transfer rate and access time. The faster the transfer rate and access time the higher the priority. Fixed head disks are usually set to a higher priority than movable head disks and DECTape and Magtape follow.

A system with a RF08, RK8E and TC08 should have the RF as priority 0, the RK as priority 1 and the TC as priority 2.

COMPANY CONFIDENTIAL

Title PDP8 OMNIBUS FAMILY "POWER OK" BUS						Tech Tip Number PDP8E-TT-21				
Processor Applicability				Author J. Blundell		Rev 0		Cross Reference		
All		8E	8M	8F				Approval Larry Narhi Date 9/13/74		PDP8M-TT-12

digital	FIELD SERVICE TECHNICAL MANUAL				Option or Designator
	12 Bit <input checked="" type="checkbox"/>	16 Bit <input type="checkbox"/>	18 Bit <input type="checkbox"/>	36 Bit <input type="checkbox"/>	PDP 8I

Title				MEMORY CURRENT ADJUSTMENT		Tech Tip Number	PDP/8I TT#1
All		Processor Applicability		Author Bill Kochman		Rev 0	Cross Reference
8I				Approval W. Cummins		Date 07/31/72	

The recommended method for setting up PDP-8I memories is by adjustment of memory current. DEC uses the following memories with the associated optimum operating currents:

Data Products (Core Memories Ltd)	360MA
Plessey Core Stores Ltd.	340MA
Electronic Memories Inc.	340MA
Data RAM Corporation	340MA
Ferroxcube Corporation	340MA

These are peak currents and are adjusted by the memory voltage pot on the G826.

Current loops can be field installed in any 8I.

1. Delete 30 AWG wiring from XR/W source C39K1 to C37T2.
2. Delete 30 AWG wiring from YR/W source C39S1 to C32T2.
3. Replace each of the above with 24 AWG green wire and leave enough slack to accommodate a current probe.

MC8I does not have a separate power source, so current loops are not necessary.

When tuning memories, use a current probe.

Ideal memory turning is strobe occurring 270 nsec after read current begins. With channel A, current probe on read/write current and channel B on strobe, calculate the 270 nsec by measuring leading edge to leading edge disregarding ten percent rise time.

Revised by Bill Kochman/January 1971

COMPANY CONFIDENTIAL

Title PDP-8I MEMORY STACK REPAIRS						Tech Tip PDP-8I TT#2 Number		
All	Processor Applicability					Author NewBury/Fuller	Rev 0	Cross Reference
	8I					Approval W. Cummins	Date 07/31/72	

PDP-8/I MEMORY STACK REPAIRS

PDP-8/I memory stack failures will usually display one of two symptoms; a bit set at all locations and/or a group of addresses with a common X or Y coordinate not accessible. An open inhibit or sense amp line will produce a set bit at every location; these leads are small gauge and break easily with handling. Typical ohms readings at the W025 connector cards with the stack out of the CP are:

a) inhibit lines - approximately 10 ohms (except BS2-BT2)
b) BS2-BT2 - thermister - approximately 300 ohms
c) sense lines - approximately 14 ohms

W025 LEAD/CONNECTOR IDENTIFICATION

MFG.	SENSE AMP LEAD COLORS	SLOT	INHIBIT LEAD COLORS	SLOT
RMI	Red/White	AB34	Black/White	AB35
Ferroxcube	Multicolor/White		Multicolor/Black	
Data-Ram	Purple/Red		Black/White	

PDP-8/I MEMORY DIODE LOCATION

The instructions which follow will assist in solving the problem of a group of addresses not accessible which is usually a result of diode failure on the stack (G610, G611, or G612 boards). 8/I Memory Diode Location and Function print #CS-3005256-0-3 and prints for G610, G611, G612, may be referenced if available, however, some copies show diode polarities incorrectly.

- 1) Give careful attention to the diagram on page 3; the circuit structure of the 8/I stack is clearly presented. A complete reading through of this procedure, with each step referenced to that diagram is suggested and will provide the understanding necessary for efficient repair.
- 2) Locate in column 1 of the table on page 5, the Xn or Yn failure in octal.
- 3) In column 2, you will find the decimal equivalent; this will be indicative of the terminal numbers which must be located on the stack. ONCE THE DECIMAL EQUIVALENT IS DETERMINED, IT MUST BE USED WITH NO FURTHER REFERENCE TO THE OCTAL VALUE. THE MARKINGS ON THE STACK (Xn, Yn, etc.) ARE IN DECIMAL.

digital	FIELD SERVICE TECHNICAL MANUAL				Option or Designator PDP-8I
	12 Bit <input checked="" type="checkbox"/>	16 Bit <input type="checkbox"/>	18 Bit <input type="checkbox"/>	36 Bit <input type="checkbox"/>	
Title PDP-8/I MEMORY STACK REPAIRS (Continued)				Tech Tip Number	PDP8I TT#2
All Processor Applicability		Author Newbury/Fuller	Rev 0	Cross Reference	
8I		Approval W.E. Cummins	Date 7-31-72		

4) For an Xn failure, this number must be interpreted to indicate terminal Xn and its opposite terminal $\bar{X}n$; for Yn failure, terminals Yn and $\bar{Y}n$ are indicated. This pair of terminals defines a read/write current path through core. The Xn, $\bar{X}n$, Yn, $\bar{Y}n$ terminals will be found by counting in DECIMAL from the marked terminals of the stack. The G610A has four rows of terminals:

- a) marked X0 - (count 0-2-4-6- etc. to 62)
- b) marked X1 - (count 1-3-5-7- etc. to 63)
- c) marked $\bar{Y}0$ and $\bar{Y}62$ - (count 0-2-4-6 etc. to 62)
- d) marked $\bar{Y}1$ and $\bar{Y}63$ - (count 1-3-5-7 etc. to 63)

The configuration of the G611B is identical and its terminals are similarly marked. It will be noted that X and \bar{Y} are on the G610 and \bar{X} and Y are on the G611.

5) From the chart on page 5 you have now identified (from column 2) the location of the terminals of the unexposed path through core and identification of the external pin connections will be found in columns 3, 4, 5, and 6. Insert the data from columns 2 through 6 into the indicated boxes in the diagram on page 4 and you will have all necessary information for determination (with an ohm meter) of the four diodes and associated circuitry which are suspect.

6) The next step is to determine that wiring, etch, and solder connections are good, which will leave only the diodes in question. A visual check of the physical arrangement of the diodes will indicate that they are connected in pairs with a common "node" terminal for each pair. As shown in the diagrams, there will be a pair of diodes on each side of the stack. With one ohm meter lead connected to a terminal, move the other probe along the rows of node points until continuity is observed. As this is done on both sides of the stack, the two node points will be located and the four diodes identified. An ohm meter reading through core from node point to node point should be approximately three ohms. A continuity check should now be made from each diode out to the external pin connections , , , and .

7) If no fault was evident in Step 6, it is reasonable to assume diode failure. REPLACE ALL FOUR DIODES; it is not possible to determine reliably the failure of a single diode and replacement of one or a pair only may result in an unbalanced circuit.

COMPANY CONFIDENTIAL

Title		PDP8/I MEMORY STACK REPAIRS (CONT.)		Tech Tip Number		PDP-8I-TT-2	
All		Processor Applicability		Author		Rev	
8I				Newbury/Fuller		0	
				Approval		Date	
				W.E. Cummins		7/31/72	
Cross Reference							

8) Special care must be taken to prevent pieces of wire or solder from dropping into the cores area. Cut the leads close to the body of the defective diode; be sure not to cut any etch beneath it. Bend the leads up vertically from the board. Form the new diode leads into loops which will fit snugly onto the now vertical stacks with the diode body flush with the board. Crimp the loops for mechanical integrity, trim excess wire, then quickly and carefully spot solder.

DIAGRAM OF 8/I MEMORY CURRENT PATH CORE
* T1 & T2 CONDUCTING WHEN SELECTED

COMPANY CONFIDENTIAL

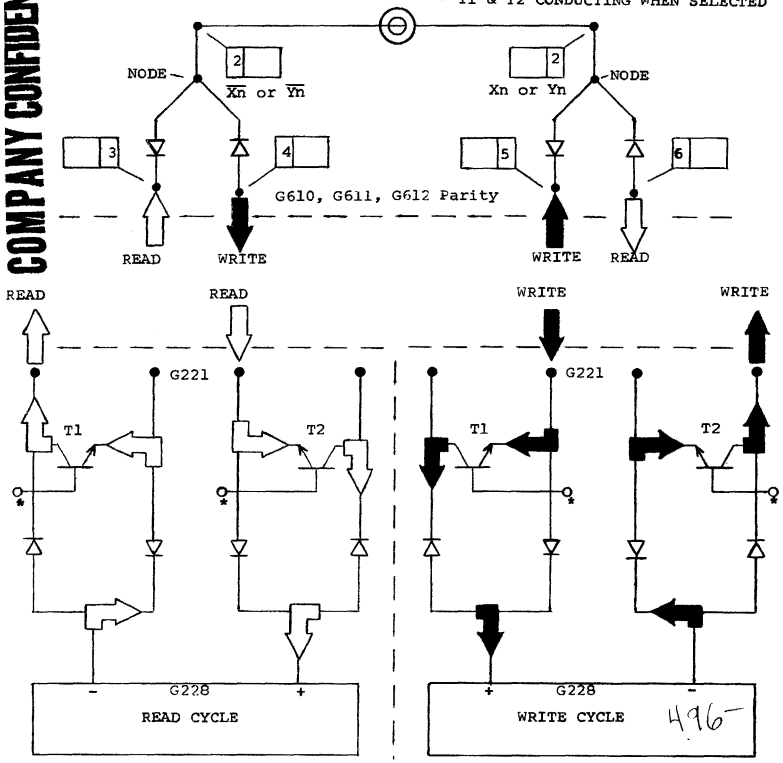

digital	FIELD SERVICE TECHNICAL MANUAL				Option or Designator
	12 Bit <input checked="" type="checkbox"/>	16 Bit <input type="checkbox"/>	18 Bit <input type="checkbox"/>	36 Bit <input type="checkbox"/>	PDP 8I

Title PDP8I Memory Stack Repairs (cont.)				Tech Tip Number PDP8I-TT-2	
All Processor Applicability		Author Newbury/Fuller		Rev 0	
8I		Approval Cummins		Date 7/31/72	
Cross Reference					

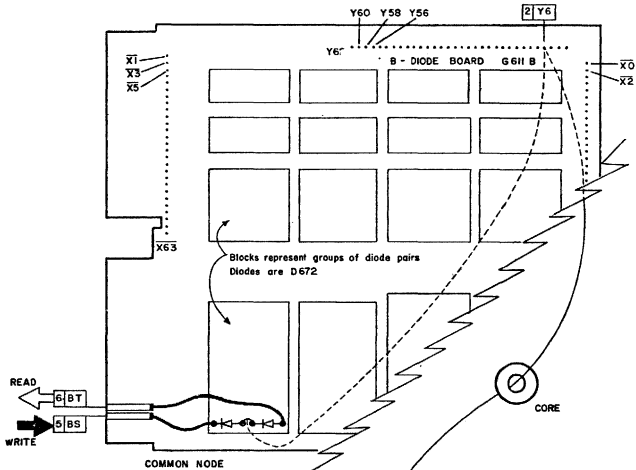

EXAMPLE

In this diagram, the circuits thru core are shown with test points indicated for Y axis, octal 06

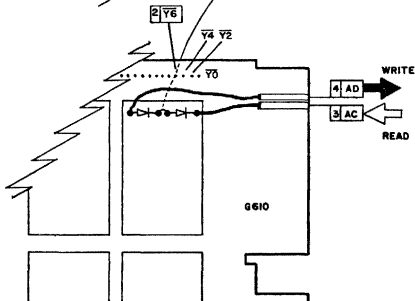

Title						TABLE OF 8I STACK CONNECTOR TERMINALS		Tech Tip Number		PDP8I TT#3	
All						Processor Applicability		Author		Newbury	
								Rev		0	
						Approval		W.E. Cummins		Date 7-31-72	
										Cross Reference	

1	2	3	4	5	6	1	2	3	4	5	6
X or Y (OCTAL)	X or Y DECIMAL	EXTERNAL PIN CONNECTIONS				X or Y (OCTAL)	X or Y DECIMAL	EXTERNAL PIN CONNECTIONS			
00	0	AD	AC	BD	BC	40	32	AN	AM	BD	BC
01	1	AD	AC	BF	BE	41	33	AN	AM	BF	BE
02	2	AD	AC	BJ	BH	42	34	AN	AM	BJ	BH
03	3	AD	AC	BL	BK	43	35	AN	AM	BL	BK
04	4	AD	AC	BN	BM	44	36	AN	AM	BN	BM
05	5	AD	AC	BR	BP	45	37	AN	AM	BR	BP
06	6	AD	AC	BT	BS	46	38	AN	AM	BT	BS
07	7	AD	AC	BV	BU	47	39	AN	AM	BV	BU
10	8	AF	AE	BD	BC	50	40	AR	AP	BD	BC
11	9	AF	AE	BF	BE	51	41	AR	AP	BF	BE
12	10	AF	AE	BJ	BH	52	42	AR	AP	BJ	BH
13	11	AF	AE	BL	BK	53	43	AR	AP	BL	BK
14	12	AF	AE	BN	BM	54	44	AR	AP	BN	BM
15	13	AF	AE	BR	BP	55	45	AR	AP	BR	BP
16	14	AF	AE	BT	BS	56	46	AR	AP	BT	BS
17	15	AF	AE	BV	BU	57	47	AR	AP	BV	BU
20	16	AJ	AH	BD	BC	60	48	AT	AS	BD	BC
21	17	AJ	AH	BF	BE	61	49	AT	AS	BF	BE
22	18	AJ	AH	BJ	BH	62	50	AT	AS	BJ	BH
23	19	AJ	AH	BL	BK	63	51	AT	AS	BL	BK
24	20	AJ	AH	BN	BM	64	52	AT	AS	BN	BM
25	21	AJ	AH	BR	BP	65	53	AT	AS	BR	BP
26	22	AJ	AH	BT	BS	66	54	AT	AS	BT	BS
27	23	AJ	AH	BV	BU	67	55	AT	AS	BV	BU
30	24	AL	AK	BD	BC	70	56	AV	AU	BD	BC
31	25	AL	AK	BF	BE	71	57	AV	AU	BF	BE
32	26	AL	AK	BJ	BH	72	58	AV	AU	BJ	BH
33	27	AL	AK	BL	BK	73	59	AV	AU	BL	BK
34	28	AL	AK	BN	BM	74	60	AV	AU	BN	BM
35	29	AL	AK	BR	BP	75	61	AV	AU	BR	BP
36	30	AL	AK	BT	BS	76	62	AV	AU	BT	BS
37	31	AL	AK	BV	BU	77	63	AV	AU	BV	BU

digital	FIELD SERVICE TECHNICAL MANUAL				Option or Designator PDP-8I
	12 Bit <input checked="" type="checkbox"/>	16 Bit <input type="checkbox"/>	18 Bit <input type="checkbox"/>	36 Bit <input type="checkbox"/>	

Title EAE ILLEGAL MICROINSTRUCTIONS				Tech Tip Number PDP8I-TT- 4	
All	Processor Applicability		Author R. Williams	Rev 0	Cross Reference
	8I		Approval W. Cummins	Date 7-31-72	

A customer recently complained of difficulty in getting correct results when normalizing certain numbers. Both Maindecs ran so a long hard look was given to the customer's software. The reason for the failure was the result of combining the instructions MQ LOAD and NORMALIZE.

In the SMALL COMPUTER HANDBOOK it appears that this combination of instructions is legal, since they are executed at different event time. The only time they are not legal is when AC bits 8 and 1 are different, which is the key to the whole problem. As soon as the AC is loaded with this combination of bits the signal NORM NOT is true and this disqualifies the gate that AND's it with NMI. When this happens we never get EAE START and never even do the NORMALIZE portion at all. This situation causes the Microinstruction MQL-NMI to be illegal.

Title NOISE ON AC PANEL SWITCH - PDP-8/I				Tech Tip Number PDP8I-TT-5	
All	Processor Applicability		Author A. Newbery	Rev 0	Cross Reference
	8I		Approval W. Cummins	Date	

Radiation from the leads of the AC panel switch on the PDP-8I causes failures in the Memory ON/OFF Test. The problem was especially acute on a 240 volt machine where the usual thyrector across the switch at the power transformer, and/or at the panel switch (the most effective location) did not work. Two (2) ECO's (8I-88827 and 704A-88885) have been issued to correct this problem. ECO 8I-88827 adds a switch filter and shielded cable to eliminate radiated noise. ECO 704A-88885 moves the G813 card off the +5 volt breaker to a position in the power supply less susceptible to RF noise.

SUPPLEMENTAL ACTION TAKEN

- ECO 8I-027 & 704-005
 MCN _____
 TECH TIP _____
 OBSOLETE _____

COMPANY CONFIDENTIAL

Title WIRE RUNS FOR PDP-8I POWER SUPPLY AND CONTROL					Tech Tip Number PDP8I-TT-6		
All	Processor Applicability				Author C. Sweeney	Rev 0	Cross Reference
	8I				Approval W. Cummins	Date 7-31-72	

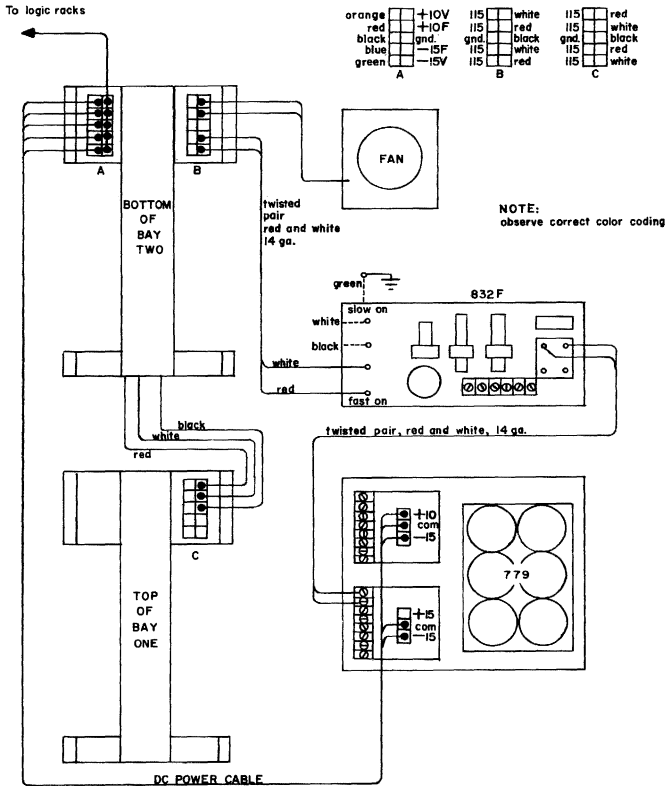

digital	FIELD SERVICE TECHNICAL MANUAL				Option or Designator
	12 Bit <input checked="" type="checkbox"/>	16 Bit <input type="checkbox"/>	18 Bit <input type="checkbox"/>	36 Bit <input type="checkbox"/>	PDP8I

Title				AUTOMATIC CYCLING OF MANUAL TIMING FOR THE PDP8I		Tech Tip Number	PDP8I-TT-7	
All	Processor Applicability				Author	W. Freeman	Rev	g
	8I				Approval	W. E. Cummins	Date	11/13/73
							Cross Reference	

The problem in scoping manual timing is that it is not possible to regenerate timing rapidly enough to observe a good waveform by repeatedly depressing the manual function keys. A viable solution to this problem has been discovered and is as follows:

1. Place a temporary jumper wire from the output of the TTO Clock (M452 slot F03 Pin K2) to replace MFT50 (M700 slot EF10 Pin EN2). This will cause the manual timing chain to be regenerated at a rate of 220 HTZ.
2. The single step or the single instruction key must be set to prevent interaction of processor timing.
3. The M707 module at EF02 must be removed to prevent the loading effect this logic would have on the TTO Clock.
4. A piece of tape must be placed on Pin ES2 of the M700 card in slot EF10 to prevent the keys from loading down the TTO Clock.

After performing the above steps, manual function timing will be available as long as power is applied to the C.P. It is also possible to observe the complete action of any of the keys merely by holding them down. The key function will continue to recycle until the key is released.

Title				DOUBLE SELECTION OF G221		Tech Tip Number	PDP8I-TT-8	
All	Processor Applicability				Author	W. Freeman	Rev	g
					Approval	W. E. Cummins	Date	11/13/73
							Cross Reference	
							G221 TT#1	

COMPANY CONFIDENTIAL

Title						Tech Tip	
RANDOM 8/I MEMORY FAILURES						Number	PDP8I-TT-9
All		Processor Applicability		Author	Rev		Cross Reference
8I				Art. Newberry	0		
				Approval	Date		
				W.E. Cummins	11/13/73		

RANDOM 8/I MEMORY FAILURES

Two sources of intermittent memory failures have been discovered:

- 1) Early stages of 6534-D transistor failure on the G221 modules will cause erratic altering of the contents of one or more locations in memory to $\theta\theta\theta\theta$. The 6534-D should be replaced by 2N2904. It has been found that some T.I. 2904's have a fall time which exceeds our specification of 10 to 90 nsec. and therefore would not cure the problem. After installation of a replacement 2904, its fall time should be checked and it should be allowed to remain in the circuit only if it is within specs.
- 2) Noise on the sense lines from the stack to the sense amps can cause peculiar problems. Although ECO 8I-00022 was not directed to the field for retrofitting, this ECO has been effective when installed on some earlier machines in the field. The Speco does not explain too clearly the add/delete scheme. You will see that the first two deletes are A30D2 to A34S2 and A30E2 to A34T2. The essence of the problem is that those two leads carry the sense signal and may not be identical in length or routing and may trigger the sense amps erroneously because of noise or phase discrepancy; the two deletes are to be replaced by one run of twisted pair. The other deletes are similarly paired; each pair is to be replaced by one run of twisted pair.
- 3) A revision must be made to G624's to permit proper operation with Ferroxcube stacks. Resistors R2, R3, R4, and R5 on the G624 have previously been 60, 70, or 52.5 ohms; if a Ferroxcube stack is to be used in a system, these resistors must be 56 ohms on every G624 in the system.
- 4) If Instruction Test 1 will not run in field 1 of a system with 8K or more of memory, it may be a result of induced noise picked up from the memory power supply lines by the memory flip-flop output lines. ECO 8I-00051 reroutes these runs to eliminate this problem.

COMPANY CONFIDENTIAL

digital	FIELD SERVICE TECHNICAL MANUAL				Option or Designator
	12 Bit <input checked="" type="checkbox"/>	16 Bit <input type="checkbox"/>	18 Bit <input type="checkbox"/>	36 Bit <input type="checkbox"/>	PDP 8I-TT-10

Title USE OF AUTO-TAP IN 230 VOLT SYSTEMS				Tech Tip Number PDP8I-TT 10	
All Processor Applicability			Author W. Freeman		Rev 0
8I			Approval W. E. Cummins	Date 12/13/73	Cross Reference

It has come to my attention that in some 230 VAC 50Hz 8I systems the Auto-Tap is used to power other devices requiring 115 VAC instead of using a step-down transformer. It should be noted that this winding on the 704 Power Supply, is limited to a maximum of 4.5 Amps. Rms load. It should also be noted that when using this tap wires should be run directly to the tabs on the transformer and not to the Ebert mercury relay coil, as has been done in the past.

Title G826 ADJUSTMENTS				Tech Tip Number PDP8I-TT-11	
All Processor Applicability			Author W. Freeman		Rev g
8I			Approval WE CUMMINS	Date 12/13/73	Cross Reference

Many G826's are returned from the field as defective when, actually, there is no defect, only misadjustment of POWER OK.

The basic operational functions of the G826 are first, to detect the AC power input going low and second, to regulate the memory voltage level. The detection of power-in going low, due to either line failure or the front panel power switch being set to the OFF position, is accomplished by sampling for variations on the 5volt bus. When the 5 volt bus drops below 4.75 volts, the condition is felt by an operational amplifier which generates POWER OK as a +3 volt level. This level becomes the conditioning level which allows the next TP3 to clear the RUN flip flop. At the same time, a turn off signal is applied to the -30 volt memory supply. These two logical events occur to disallow a random read without its associate write cycle. When POWER OK is at +3 volts, the RUN flip flop will act as if the SINGLE STEP switch were on and -30 volts will not come up.

The memory voltage level is set by a pot which is in parallel with an amplifier between the -6 volt and -30 volt supplies. In normal operation, POWER OK is low (0 volts). With a scope sampling at A02J2 (of the 8I) or the negative probe of a meter on that point, with the positive probe to ground, adjust the helipot, in the center of the module, clockwise until POWER OK just goes low(0 volts), then a few degrees more.

COMPANY CONFIDENTIAL

Title G826 ADJUSTMENTS (cont.)						Tech Tip Number PDP8I-TT-11		
All	Processor Applicability					Author	Rev	Cross Reference
	8I					W. FREEMAN	β	
						Approval	Date	
						W. E. CUMMINS	12/13/73	

With POWER OK low, memory voltage may now be adjusted; set up meter connections as follows:

METER LEADS

	NEGATIVE	POSITIVE
8I	B02V2	B02M2
8L	B27V2	B27M2

Adjust the Bourns pot on the edge of the module for a reading of +21 to +22.5 volts.

PDP 8L's logic serial #150 and later, have a power supply connector card, G785 revision "D" or later, which will make the POWER OK adjustment less critical. They have an extra detection circuit which is OR'ed with the output of the differential amplifier at pin AJ2 which stops the CP before the +5 volt line begins to drop.

After these adjustments have been made the memory power ON/OFF test should be run. The helipot is mechanically sensitive; after adjustment, a spot of nail polish or paint should be applied to the adjustment stem to secure it in the desired position.

Title G826 REV. K						Tech Tip Number PDP8I-TT#12		
All	Processor Applicability					Author	Rev	Cross Reference
	8I					W. Freeman	β	
						Approval	Date	
						W. E. Cummins	12/1/73	

When installing a revision K G826 in an 8I make sure that ECO G805-00002 is installed. If it isn't and a G826 revision K is installed, it is very easy for the trim pot in the center of the board to short out the -30 volts on the G805.

The ECO consists of installing two spacers on the G805 with nylon screws. The spacers can be ordered with the part #90-06968 and the screws with part #90-06401.

COMPANY CONFIDENTIAL

digital	FIELD SERVICE TECHNICAL MANUAL				Option or Designator
	12 Bit <input checked="" type="checkbox"/>	16 Bit <input type="checkbox"/>	18 Bit <input type="checkbox"/>	36 Bit <input type="checkbox"/>	PDP-8L

Title <u>BUFFERING OF POWER CLEAR</u>				Tech Tip PDP-8L TT#1											
All Processor Applicability		Author Robert Nunley	Rev <u>g</u>	Cross Reference											
<table border="1"> <tr> <td>8L</td> <td></td> <td></td> <td></td> <td></td> <td></td> <td></td> <td></td> <td></td> <td></td> </tr> </table>		8L										Approval <u>W. Cummins</u>	Date <u>7-31-72</u>		
8L															

The Power Clear signal run, generated at A25S2 is **overloaded** beyond engineering specs. However, because we use the level rather than transition, this overload is acceptable in most machines. In the rest, due to component age and component individual characteristics, weird unexplainable things might happen with any or all of the following symptoms.

1. Intermittent halt when none was programmed (not to be confused with loss of timing where run is on but there is no control of the machine) where run is cleared as if the halt key was actuated.
2. Intermittent loss of data where one memory cell is changed to 0000.
3. Intermittent clearing of flags and/or buffers in I/O devices (not connected to a DM01).

If any of these systoms occur it is possible that the cause is the power clear run.

If a glitch appears on power clear this is what can happen:

1. If the glitch appears before TP3 but after TP2 memory control flops will be cleared and as a result one memory location will be cleared, but the MB will have the correct data this time. TP3 will then set RUN and the program should resume normal flow (until the zero's are reached again).
2. If the glitch appears after TP3 the effect is as if the SS key is pressed.
3. Depending on where the glitch occurs between MEM start and strobe governs whether or not a read is done at all, or a strobe is generated.
4. If the glitch appears in the 8L of amplitude and duration enough to cause any of the above, it will be felt on the I/O bus and cause the same type intermittent problems.

To buffer Power Clear: break the Power Clear run at A27S2 but maintain the other end (could go to D16A1 or B13R1 depending on the vintage of the 8L).

Add A27S2 to C27E2
 Add C27J2 to other end of wire deleted in the first step.
 Add 220 ohm 1/4W pull up

C27J2 to +5V

This gives a drive of about 100 load units for the Power Clear run.

COMPANY CONFIDENTIAL

Title PRINT CORRECTIONS IN 8L					Tech Tip Number PDP-8L TT #2		
All	Processor Applicability				Author Robert Nunley	Rev 0	Cross Reference
	8L				Approval W. Cummins	Date 7-31-72	

There are errors in the 8L print set not in Logic Gating but in signal names and generation. Two of these errors have been corrected by ECO's which will be coded "P" therefore will not be distributed to the field.

The corrections are:

1. Drawing No. D-BS-8L-Ø-2 coordinates D-7 direct clear of TSI is not ~~stroke~~, but the "OR" function of ~~POWER CLEAR + STROBE~~. The signal comes from Inverter M111 at A35H1. (This gating was generated by ECO 8L-00045, ECO 8L-00059, ECO 8L-00062.) Direct Clear of TSI should now be called "A35H1."
2. Drawing number D-BS-8L-Ø-13 coordinates B-6 generation of "CP Power OK." The logic works correctly but should be drawn like this.

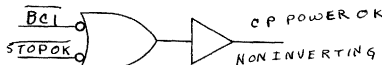

Title 8L ECO 00045, 00056 ERROR					Tech Tip Number PDPS/L TT#3		
All	Processor Applicability				Author Art Newbury	Rev 0	Cross Reference
	8L				Approval W.E. Cummins	Date	

Another ECO will be generated to effect correction of an error which exists with respect to ECO's 8L #00045 and 00056. The schematic which is part of the Speco for 8L 00056, shows correctly that there are three inputs to the M115 which is added in slot C28. The Add/Delete sheet, however, fails to include the wiring of the TS4 (Ø) input to C28B1. The following Add will resolve the problem:

C28B1 to CØ4V1

COMPANY CONFIDENTIAL

digital	FIELD SERVICE TECHNICAL MANUAL				Option or Designator
	12 Bit <input checked="" type="checkbox"/>	16 Bit <input type="checkbox"/>	18 Bit <input type="checkbox"/>	36 Bit <input type="checkbox"/>	PDP-8L

Title 3 CYCLE BREAK INTERMITTENT					Tech Tip Number PDP8L-TT-4
All	Processor Applicability	Author S. Lamotte	Rev 0	Cross Reference	
8L		Approval W.E.Cummins	Date Aug 15		

PROBLEM: 3 Cycle break devices, with cables over 15ft. in length, have displayed a problem of intermittently not setting "Break". This is caused by "Ext 3 cycle L" being noisy at the processor. This condition brings up WC Set, when it shouldn't be there.

FIX: Ground "ext 3 cycle L" signal at processor, A34V2 B34C2

This Tech Tip apply's only to systems with 3 cycle break options, and no 1 cycle break devices.

Title 8L FUSE RATINGS					Tech Tip Number PDP8L-TT#5
All	Processor Applicability	Author W. Freeman	Rev 0	Cross Reference	
8L		Approval W.Cummins	Date 12/1/73		

Because of the complaints about the 5 amp fuse in the +5 volt line (F-3) in the 718 power supply, an investigation was undertaken. The following facts have been revealed:

- 1) The PDP-8L draws six amps on the +5 volt line under full load conditions.
- 2) This load will occasionally blow the 5 amp fuse (F-3)
- 3) The other two fuse ratings were found to be correct.

It was found that the use of a 6 amp fuse for F-3 produced reliable operation. An ECO for changing this specification (#718-00007) is being prepared for distribution. This will be a permanent change for all 718 power supplies. The proper fuse ratings for the 718 power supply are:

F-1	15 amp slow blow
F-2	4 amp slow blow
F-3	6 amp common

COMPANY CONFIDENTIAL

Title						Tech Tip	
8L AFFECTED BY EXTERNAL NOISE						Number PDP8L-TT-7	
Processor Applicability						Cross Reference	
All						Author W. Freeman	Rev g
	8L					Approval W. E. Cummins	Date 11/14/73

If external noise from surrounding equipment is affecting an 8L, the installation of a .1 mfd. capacitor on the G785 module as shown in the schematic below will resolve the problem.

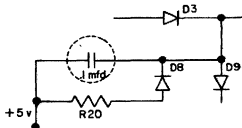

Mel Arsenault

March 1969

Approximately 150 8/L's have been shipped to the field with the capacitor connected to the base of Q1 rather than the junction of D3, D8, and D9. A symptom indicative of this condition is random stopping in the run state, all switch functions inoperative and inability to restart except following a power-down, power-up operation.

Title						Tech Tip	
B RUN NOISE						Number PDP8L-TT-8	
Processor Applicability						Cross Reference	
All						Author W. Freeman	Rev g
	8L					Approval W. Cummins	Date 12/05/73

B RUN NOISE

It has been found that ground noise caused by the MB bits is causing B RUN to move. The noise can be eliminated by tying the emitters of all the transistors on the M623 together.

ECO's M623 - 00001 and 00002 implement this solution.

Title						Tech Tip	
DOUBLE SELECTION OF G221						Number PDP8L-TT -9	
Processor Applicability						Cross Reference	
All						Author W. Freeman	Rev g
	8I	8L				Approval W. E. Cummins	Date 12/05/73
						G221-TT-1	

COMPANY CONFIDENTIAL

digital	FIELD SERVICE TECHNICAL MANUAL				Option or Designator
	12 Bit <input checked="" type="checkbox"/>	16 Bit <input type="checkbox"/>	18 Bit <input type="checkbox"/>	36 Bit <input type="checkbox"/>	PDP8-M

Title PDP8-M BOUNCE IN CONSOLE KEYS				Tech Tip Number PDP8M-TT-1	
All Processor Applicability			Author J. Blundell	Rev 0	Cross Reference
8M			Approval W. Cummins	Date 06/21/72	

CAUSE: Some console boards may have the wrong resistor installed in the switch filter circuit.

CHECK: ECO 5409668-004 should be installed anyway, but also check to see that R51 is 15K (brown, green, orange). Bad boards had 51K (green, brown, orange).

The resistor is located on the right at the top of the board. From the right edge count in five I.C.'s then it is the fourth (4th) resistor. (Next component across is another resistor, then a small capacitor).

Also note that although this resistor is called out correctly in the parts list the circuit schematic in the drawing set shows it as 1.5K. This is a mistake. 1.5K will not work and an ECO is in progress to correct this drawing.

COMPANY CONFIDENTIAL

Title		Procedure for Adjusting 8/M Power Supply				Tech Tip Number		PDP8M-TT-2	
All	Processor Applicability				Author	R. Boehm	Rev	0	Cross Reference
	8E				Approval	W. Cummins	Date	07/31/72	

Due to the locations of pots for voltage adjustments (under transformer) it is necessary to remove and dismantle power supply. This should be done by the following procedure.

NOTE: Turn OFF power.

1. Remove four (4) screws from underneath 8/M.
2. Slide power supply out through back of 8/M being careful not to scrape wires and connectors.
3. Remove plug from front end of heat sink (see drawing).
4. Remove 6 screws (3 per side) that hold power supply circuit card (see drawing).
5. Remove circuit card.
6. Replace plug that was removed in Step 3.
7. Turn on power and start program.
8. Adjust voltages (see drawing).
9. DO NOT leave power ON for more than 15 minutes with power supply outside of 8/M. This is due to overheating.
10. Replace power supply in reverse of removal.

COMPANY CONFIDENTIAL

digital	FIELD SERVICE TECHNICAL MANUAL				Option or Designator
	12 Bit <input checked="" type="checkbox"/>	16 Bit <input type="checkbox"/>	18 Bit <input type="checkbox"/>	36 Bit <input type="checkbox"/>	PDP-8M

Title				PROCEDURE FOR ADJUSTING 8M POWER SUPPLY (Contin.)		Tech Tip Number PDP8M-TT-2	
All		Processor Applicability		Author R. Boehm		Rev 0	
8M				Approval W. Cummins		Date 07/31/72	
						Cross Reference	

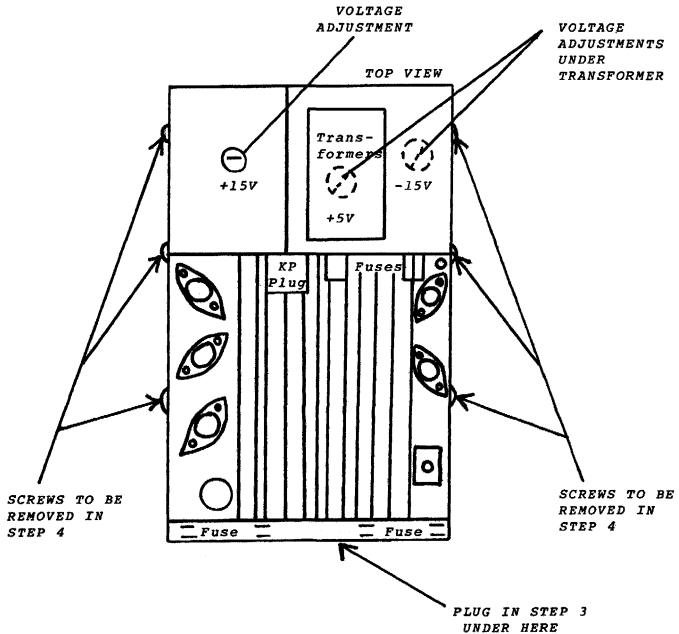

COMPANY CONFIDENTIAL

Title PROCEDURE FOR ADJUSTING 8/M POWER SUPPLY (CON'T)					Tech Tip Number PDP8M-TT-2		
All	Processor Applicability				Author R. Boehm	Rev 0	Cross Reference
	8m				Approval W. Cummins	Date 07/31/72	

SIDE VIEW

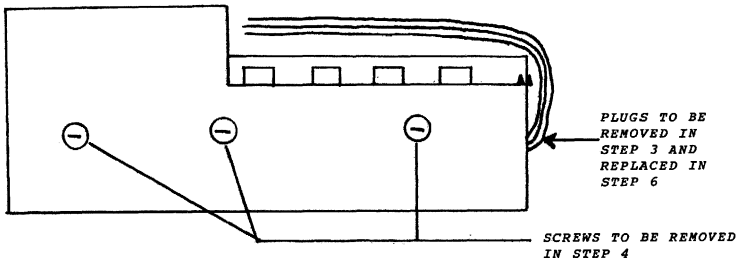

Title PDP8/M and 8/F PROGRAMMERS CONSOLE					Tech Tip Number PDP8M-TT-3		
All	Processor Applicability				Author J. Blundell	Rev 0	Cross Reference
	8M	8F			Approval F. Purcell	Date 09/14/72	

Some systems have been seen in house that go into RUN when the examine or deposit keys are used.

Investigation of the problem suggests it is caused by haise pickup on the wires going to the 22f timing capacitors from the one-slots added by the ECO 5409668-004.

If you experience the problem on the field try moving the capacitors so that they are physically positioned between the timing resistors and the 74123 one slot itself, before you spend any time investigating in more detail.

An ECO is in progress at this time to make this an official production change.

**SUPPLEMENTAL ACTION
TAKEN**

- ECO 5409668-004A
- MCN _____
- TECH TIP _____
- OBSOLETE _____

DIGITAL EQUIPMENT CORPORATION

COMPANY CONFIDENTIAL

digital	FIELD SERVICE TECHNICAL MANUAL				Option or Designator
	12 Bit <input checked="" type="checkbox"/>	16 Bit <input type="checkbox"/>	18 Bit <input type="checkbox"/>	36 Bit <input type="checkbox"/>	PDP8/M

Title PDP8/M POWER SUPPLY				Tech Tip Number PDP8/M-TT-4		
All	Processor Applicability			Author J. Blundell	Rev A	Cross Reference
	8M			Approval F. Purcell	Date 01/23/73	

There exists some confusion on the field with ordering spare parts for the PDP8/M power supply due to the designation H740 used in the drawing set.

THE PDP8/M SUPPLY IS NOT AN H740

Originally, there were several flavours of the H740 (A, B, C, etc) but this led to confusion and the letter designations were dropped for the computer supplies (8M, 8F and 11/05).

If you need spare you should order as follows:

54-09728 (Etch Rev. C or later)	Regulator Board
16-10601-02	Transformer
74-09376	Chassis
70-08537	AC Harness
70-08675	DC Harness
74-09375	Bracket (6 required)
90-06020-1	Screw (12 required)
90-06633	Washer #6 (12 required)

The last three items may be important to you if you return a regulator board with the support brackets on it, since a new board has no brackets.

The most likely semiconductors you may need are:

15-10705	Transistor	GPS A05
15-10706	Transistor	GPS A55
11-10714	Diode Bridge	NSS 3514 200V peak inverse, 20 amp forward current.
15-10928	SCR	C32AX135 +5 crowbar for Etch C
15-10899	SCR	C32BX179 +5 crowbar for Etch B

Plus, for the Etch Rev. C or D supplies only; (Etch B uses fast blow cartridge fuses).

10 amp	Pico Fuse	12-10929-01
15 amp	Pico Fuse	12-10929

COMPANY CONFIDENTIAL

Title						Tech Tip	
WIRING ERROR IN THERMOSTAT CIRCUIT						Number PDP8/M-TT-5	
Processor Applicability				Author		Rev	
All				C. Showers		A	
8M 8P				Approval F. Purcell		Date 12/1/72	
Cross Reference							

Problem #1

Some of the early 8M's shipped (up to serial #2100 approx.) may have had Pins 2 and 6 on J1 (the connector going to the transformer) reversed.

SYMPTOM:

110 volt machines: Unplugging thermostat does not power down system.

220 volt machines: Circuit breaker may trip, or Power Supply transformer may start smoking.

CURE:

Next call check thermostat operation and correct wiring if necessary. (Note: 220 volt systems are okay, since the problem is seen and corrected in production when they blow up.)

WARNING: The exact details of the wiring error are not confirmed. The symptoms are as stated, and it was a two wire swap, but it may have been two other pins. Any details either confirming the above pin numbers, or correcting them would be appreciated by PDP8 Product Support.
(Jeff Blundell, PK3-2)

Problem #2

The F.S. Stockroom has shipped some harnesses with pins 3 and 6 of P1 (the connector going to the AC input box) reversed. This has no effect on 115 volt systems (BC05H), but will cause problems on 220 volt (BC05J) systems, since it puts full input voltage across only half the transformer primary. The only check is to check the harness wiring before installation.

The Field Service Stockroom has been purged, and also the Reading U.K. Stockroom

Moral - When replacing the AC harness (70-08537) on old (short chassis) 8M, 8P or 16M processor check the wiring carefully first.

digital	FIELD SERVICE TECHNICAL MANUAL				Option or Designator
	12 Bit <input checked="" type="checkbox"/>	16 Bit <input type="checkbox"/>	18 Bit <input type="checkbox"/>	36 Bit <input type="checkbox"/>	PDP8M

Title				FIT OF REGULATOR BOARD IN NEW 8M/8F CHASSIS		Tech Tip Number	PDP8M-TT-6
All	Processor Applicability			Author	Jeff Blundell	Rev	0
	8M	8F		Approval	Frank Purcell	Date	03/28/73
							Cross Reference

Starting in May, some shipments of the new PDP8M chassis will be made, leading to a complete changeover to the new chassis by July or August. You will find it much easier to work on, especially in the power supply area, which is now available behind a removable service panel at the rear.

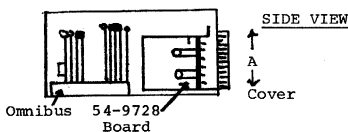
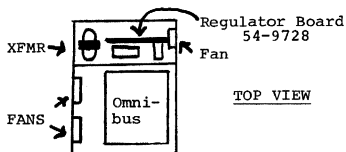

However, there is one problem you should be aware of. When the 54-9728 regulator board is manufactured it starts life as a board measuring approximately 6½" X 12". This should be eventually trimmed to its final size of 5.05" X 10.5", thus removing the crop marks on the etch. You will find many of the boards in your spares are oversize, with the crop marks still visible at the corners, and these will not fit in the new chassis, as dimension 'A' in the drawing will not tolerate a board wider than about 5.10.

Customers will not be impressed if you have to file or hacksaw a new board to fit in their machines, so check your boards carefully and trim them in the office before calling on a customer with power problems in a new style 8M or 8F.

The Field Service stockroom and depot repair have been warned, and will purge their stock during the coming months, but you should check yours now, before you get caught.

JB/mt

NOTE: See Sales Update Vol. 4 Number 17 for better pictures with dimensions.

COMPANY CONFIDENTIAL

Title USING PROGRAMMERS CONSOLE WITH EXTENDER BOARDS						Tech Tip Number PDP8M-TT-7		
All	Processor Applicability					Author Paul Gardner	Rev g	Cross Reference
	8M					Approval Jeff Blundell	Date 25 Sept. 73	

It is not necessary to remove the bezel and associated hardware when troubleshooting in order to temporarily add a programmers console to a PDP8M equipped with only the operators panel.

If you add a 15" length of blue wire to pin DB2 of a W987 quad extender, and terminate the wire with a 90-07917-0 fast on connector, the extender can be plugged into slot 1 (in front of the M8330) with the blue wire supplying -15 volts to enable the switches and LED's.

- Note:
1. The "panel lock" switch will not be operative when working this way.
 2. SW switch must be UP on the operators panel to allow the programmers panel SW switch to function.

Title OMNIBUS ORDERING INFORMATION						Tech Tip Number PDP8M-TT-8		
All	Processor Applicability					Author J. Blundell	Rev g	Cross Reference
	8E	8M	8F			Approval F. Purcell	Date 2/7/74	

This Tech Tip is issued for cross reference purposes.

Title 54-9728 P.S. REGULATOR BOARD COMPATIBILITY						Tech Tip Number PDP8M-TT-9		
All	Processor Applicability					Author J. Blundell	Rev 0	Cross Reference
	8M	8F				Approval F. Purcell	Date 1-14-74	

This Tech Tip is issued for cross reference purposes.

Title 54-9728 - NOTES ON RECENT ECO'S						Tech Tip Number PDP8M-TT-10		
All	Processor Applicability					Author J. Blundell	Rev 0	Cross Reference
	8M	8F				Approval Jim Bray	Date 7/9/74	

This Tech Tip is issued for cross reference purposes only.

COMPANY CONFIDENTIAL

digital	FIELD SERVICE TECHNICAL MANUAL				Option or Designator
	12 Bit <input checked="" type="checkbox"/>	16 Bit <input type="checkbox"/>	18 Bit <input type="checkbox"/>	36 Bit <input type="checkbox"/>	PDP8M

Title AC WIRING TO CHASSIS FANS (220 VOLTS SYSTEM)				Tech Tip Number PDP8M-TT-11	
All		Processor Applicability		Author Jeff Blundell Rev g	
8M	8F			Approval Paul Gardner Date 8/21/74	
				Cross Reference	

The two four pin sockets on the BC20A (115 volts) are electrically identical, and it makes no difference in which order the transformer primary and the fans are plugged in. (The two 2 pole sockets, for power switch and thermostat, are in series, and again it makes no electrical difference what plugs where).

However, on 220 volt BC20B line sets, only P4, the four pin socket furthest away from the two pin sockets, has noise suppression capacitors across it. These capacitors are provided to help damp switching transients that could cause memory corruption at power on/off time.

It is therefore worth checking to see that the fans are plugged into the correct socket when working on any long chassis 8M or 8F.

T= Thermostat
SW= PWR. Switch

BC20

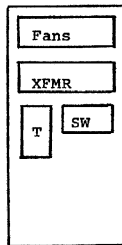

Rear View

digital	FIELD SERVICE TECHNICAL MANUAL				Option or Designator
	12 Bit <input checked="" type="checkbox"/>	16 Bit <input type="checkbox"/>	18 Bit <input type="checkbox"/>	36 Bit <input type="checkbox"/>	PDP8M

Title PDP8 OMNIBUS FAMILY "POWER OK" BUS				Tech Tip Number PDP8M-TT-12	
All Processor Applicability		Author J. Blundell	Rev 0	Cross Reference	
8E	8M	8F	Approval Larry Nathi	Date 9/13/74	PDP8E-TT-20

The "Power OK H" Bus Line (pin BV2) is pulled towards ground by a 500 ohms to -15 volts terminating resistor on the M8320 bus loads board. There is also a diode on the M8320 to pull "Stop L" low if "Power OK H" ever goes low.

It therefore follows that pin BV2 must be pulled high by a current source of at least 36 mA to get +3 volts on the bus. When a system gets expanded, and two power supplies are connected to the "Power Ok" Bus, then either supply must be capable of pulling the other supplies source down to ground should it detect a "Not Power Ok" situation.

8E supplies, (the H724 and H721 expander) have driver circuits on Power Ok that can both source and sink current. (source is around 120 mA, sink is limited to 600 mA by transistor parameters), and so 8E's should have a continuous Power Ok Bus Run, with all supplies connected to it.

The PDP8M expansion rules are different, because the bus driver on the 54-9728 regulator board is not an active current sink to ground. The 54-9728 (up to and including etch Rev E) can supply about 100 mA, but the sink (when the supply is not Power Ok) is represented by 100 ohms to ground.

It follows that if a PDP8M is expanded with a BA8A containing an H724, and the "Power Ok H" Bus has both the 54-9728 and the H724 outputs on it then if the 54-9728 detects a Power Low condition it will be unable to pull the bus low, since the H724 will source enough current to hold the bus positive even with the 54-9728's 100 ohms to ground.

The rule when expanding the 8M chassis is to cut the BV2 jumper on the BC08H cable so that each power supply only controls a portion of the bus. If the H724 fails, it will pull "Stop L" through the diode on the M8320 and stop the processor at the end of the cycle. If the 8M supply detects a power not ok situation, it will stop the processor through the "Power Ok H" Bus.

With an expanded 8M or 8F system, options that pull "Power Ok H" as part of their function (such as the M18E Bootstrap) should be put in the PDP8M processor chassis, not the expander box.

digital	FIELD SERVICE TECHNICAL MANUAL				Option or Designator
	12 Bit <input checked="" type="checkbox"/>	16 Bit <input type="checkbox"/>	18 Bit <input type="checkbox"/>	36 Bit <input type="checkbox"/>	PDP8S

Title SUMMARY OF MEMORY PROBLEMS				Tech Tip Number PDP8S-TT#1	
All	Processor Applicability			Author W. FREEMAN	Rev 0
	8S			Approval W.E.CUMMINS	Date 12/13/73
					Cross Reference

CAPACITOR/MODULE CONTRACT

Intermittent memory problems have resulted from contact between G803 modules and capacitors on the stack. The four tantalum capacitors on the forward G609 in slot D28 should be insulated with a layer of electrical tape to eliminate this possibility. It is not necessary to remove the stack to apply the tape; removal of the last two G803's in slots D26 and D27 (or W533's) will allow access to the capacitors. This modification should be made on a "next service call" basis.

RESISTOR VALUES ON G609's

Parity errors and loss of bits in memory can be the result of incorrect resistor values on G609's. For Ferroxcube stacks, R10 which is across terminals AC and AD should be 1500 ohms; R10 should be 2700 ohms for EMI stacks.

INTERMITTENTS

- Check for proper values of components in the temperature compensation network.
- See that all W532 sense amps are the same revision.
- See that G803's are not intermixed with W533 (inhibit drivers).
- On each module row A thru F a pair of 6.8 of 35 volt caps should be inserted across the +10 volt and 15 volt lines to ground. These filters should appear somewhere in module locations 1-4 of the above rows.

ADJUSTMENTS

- The Memory Done signal (D36N) should be 7.2 usec negative.
- While doing a JMPO, adjust the A702 for 4.1 volts peak to peak output at sense amp "0" (C21J).

EXTENDED MEMORY

In a PDP8/S system with extended memory, the memory done signal must be 8.0 us negative. The strobe for each extended memory is adjusted by an R302 delay. It should be adjusted so that the test point (Pin L) on the G803 (or W533) coincides with strobe. The strobe is narrower and will be contained within the test point waveform.

COMPANY CONFIDENTIAL

Title						Tech Tip Number		PDP8S-TT-1	
SUMMARY OF MEMORY PROBLEMS (cont.)						Author		Rev	
Processor Applicability						W. Freeman		0	
All						Approval		Date	
8S						W.E.Cummins		12/13/73	
						Cross Reference			

PARITY ERRORS/A702

The absence of a jumper on the A702 (rev A), memory voltage supply module, can result in intermittent parity errors. A jumper wire can be installed on the module from pin U to the center tap of the trim pot or a later revision module installed to correct the problem. Correct operation can be checked by applying a freeze spray to the rear thermister on the stack; memory voltage should increase approximately 2 volts.

Title						Tech Tip Number		PDP8S-TT-2	
PDP-8/S ECO SYNOPSIS						Author		Rev	
Processor Applicability						W. Freeman		0	
All						Approval		Date	
8S						W.E.Cummins		12/13/73	
						Cross Reference			

<u>ECO</u>	<u>LOGIC #</u>	<u>EQUIPMENT</u>	<u>NATURE OF CHANGE</u>
1	101& future	PDP-8/S	Adds clamps by internal wiring change clamps from 1F08J to 1F09J on MB print. Increase driving capability, remove AC powers sensing, free clear AC bus from time dependence.
2	101	PDP-8/S	Delete AC line wiring from power clear module W506 in IC40.
3	101	PT08	Adds a G701 module to remove ringing on cables.
6	101	8/S	Add delay to start pulse on Run, Add inverter to start pulse (-SP) to gain 100 ns delays in setting of Run.
10	397	8/S (8K)	Remove PCP from clearing the memory buffer.

COMPANY CONFIDENTIAL

digital	FIELD SERVICE TECHNICAL MANUAL				Option or Designator
	12 Bit <input type="checkbox"/>	16 Bit <input type="checkbox"/>	18 Bit <input type="checkbox"/>	36 Bit <input type="checkbox"/>	PDP8S

Title PDP-8/S ECO SYNOPSIS (cont.)				Tech Tip Number PDP8S-TT-2	
All Processor Applicability			Author W. Freeman	Rev 0	Cross Reference
8S			Approval W.E. Cummins	Date 12/13/73	

<u>ECO</u>	<u>LOGIC#</u>	<u>EQUIPMENT</u>	<u>NATURE OF CHANGE</u>
12	285, 293, 295, 299, 317, 319, 320, 321, 323, 324, 325, 329, 330, 339, 347, 348, 349, 350, 409		To increase the start pulse (-SP) to 400 ns) Change R602 to an R602 to increase start pulse to 400 ns in order to allow inverted pulse driving Run DCD gate to be negative for 400 ns.
15	540	PT0 8	Modification provides 2MA clamped loads on the BAC inputs of the W707. This change is necessary so that more than one PT08 A,B,C, can be used with a PDP-8/S. without wiring in clamped loads.
16	430&438	8K only 8S	Auto restart and power fail detection. Delete Gate 1D36 (R111) and add gate 1F36 (R113) Adds new instruction IOT 6102 skip on low power fail generates an interrupts.
16A	430 & 438	8K only 8S	Correct errors on ECO#16
16B	430&438	8K only 8S	Correct ECO #16A
20	430&438	8Konly OMD 8/S	Correction to allow OMD 8/S to operate. Connect MPC bringout buffered parity bring out proper side of buffered MA.

COMPANY CONFIDENTIAL

Title		Tech Tip	
PDP8S ECO SYNOPSIS (cont.)		Number PDP8S-TT-2	
All	Processor Applicability	Author	Rev 0
		Approval	Date
		W. Freeman	12/13/73
		W. F. Cummins	
			Cross Reference

ECO	LOGIC#	EQUIPMENT	NATURE OF CHANGE
21	1-19 & future	OMD 8/S	Change O - DMBA pulse to insure that Data Break will work during power on and off transients.
24	1-19 & future	8K only OMD8/S	Replace R107 with S107 in BMB lines. Eliminate problems by slow fall time.
28	385-429	8K only 8/S	Changes required to install the options Auto Restart on PDP-6 wire wrapped machines. The purpose of this ECO is to allow all 8K machines not covered by ECO 16, 16A, 16B, 18 to have auto restart installed as option. Adds new instruction IOT 6102.
29	101		To remove ringing on the I/O clear accumulator bus line. To invert clear I/O twice so that it will have no effect on computer when doing a 7420. The ringing was becoming excessive at 20ft or longer I/O cable lengths.
34	101	8/S	Remove -10V reference from Power Clear Board. To eliminate morning sickness. When machine is turned on sometimes the memory tab voltage is high enough to cause power clear board to keep its three output pulses at ground potential.
35	101-224	4K only 8S	Changes required to install the option Auto Restart on PDP-4 wire wrapped machines. Adds new instruction IOT 6102.
36 A B	225-816	8K 8S	Allow 1S2 indirect to operate with extended memory.

COMPANY CONFIDENTIAL

digital	FIELD SERVICE TECHNICAL MANUAL				Option or Designator
	12 Bit <input checked="" type="checkbox"/>	16 Bit <input type="checkbox"/>	18 Bit <input type="checkbox"/>	36 Bit <input type="checkbox"/>	PDP 8S

Title PDP8S ECO SYNOPSIS (cont.)				Tech Tip Number PDP8S-TT-2		
All	Processor Applicability			Author W. Freeman	Rev 0	Cross Reference
	8S			Approval W. E. Cummins	Date 12/13/73	

<u>ECO</u>	<u>LOGIC #</u>	<u>EQUIPMENT</u>	<u>NATURE OF CHANGE</u>
37	1-48	OMD 8/S	Correct OMD8S prints to comply with ECO 336
49	225 -future	8Ktype machine	This ECO is to make the temperature compensating circuit respond linearly with changing temp.

The ECO's that should be in every basic 8/S computer to improve reliability are PDP-8/S ECO:

- 1
- 2
- 3
- 5 (8K only)
- 6
- 10 (8K only) 379 & future
- 12 (as specified)
- 29
- 34
- 49

Title INVALID 8S OPERATE MICRO INSTRUCTIONS				Tech Tip Number PDP-8S-TT-3		
All	Processor Applicability			Author R. Wilson	Rev 0	Cross Reference
	8S			Approval B. Shelley	Date 5-13-74	

As documented in various manuals, a PDP-8S will not correctly perform an IAC microcoded with any rotate instruction. (This is also true of the PDP-8.) However, an 8S will also not correctly execute a CMA microcoded with any rotate. For this reason certain DEC software, such as EDU-5 and EDU-10, will not run on a PDP-8S.

COMPANY CONFIDENTIAL

-- NOTES --

digital	FIELD SERVICE TECHNICAL MANUAL				Option or Designator
	12 Bit <input checked="" type="checkbox"/>	16 Bit <input type="checkbox"/>	18 Bit <input type="checkbox"/>	36 Bit <input type="checkbox"/>	PDP-14

Title OPTION LIST					Tech Tip Number PDP14-TT-1	
All	Processor Applicability			Author C. Gamage	Rev g	Cross Reference
14				Approval W. Cummins	Date	

The following options have been developed for, or are being used with, the PDP-14:

<u>Option</u>	<u>Description</u>
BA14	A-Box
BB714	Auxiliary power supply option
BC14-A	I/O Cable
BC14-B (Obsolete)	Differential coax for DB14 option
BC14-C	I/O Test Unit
BC14-D	Serial transmission cable for DC14 option
BF14-F (Obsolete)	Storage Box (32 Flip-Flops)
BF14-H (Obsolete)	Storage Box (16 Flip-Flops)
BF14-M	Storage Module (16 Flip-Flops)
BK022	Storage Card (2 Flip-Flops)
BK272	Single retentive memory (mercury wetted)
BK274	Dual retentive memory (Reed)
BK302	Timer
BT14-A	Interrogator Box (test unit)
BX14-DA	I-Box, 115 VAC
BX14-DD	I-Box, 10 - 55 VDC
BX14-SA	I-Box, 115 VAC Schmitt Triggers
BY14-DA	Output Box 115 VAC
BY14-DD	Output Box 10 - 25 ϕ VDC
DA14-I	Interface to PDP-8I
DA14-L	Interface to PDP-8L, 8E, 8M, 12.
DB14 (Obsolete)	Multiple parallel interface
DC14-A,B,C,D	Serial line interface (PDP-8E, 11)
DD14-A	PDP-11 wire wrap panel for use with DC14
DL14-A	Transition monitoring, MAP
DMA-14	"Direct Memory Access" interface (special unit designed to customer's specifications, limited release)
DW08B	Positive bus interface, PDP-8I to PDP14/4L.
KABE	Positive bus interface, PDP-8E to PDP14/4L.
KM14-A	Severe environment option
MR14	Read Only Memory (ROM)
MR14-B	Read Only Memory Braid
SP14-MR (Obsolete)	PDP-14 Spare Parts List

COMPANY CONFIDENTIAL

Title						Tech Tip	
DOCUMENTATION LIST						Number	
Processor Applicability						PDP14-TT-2	
All	Author					Rev	A
14	C.F.Silva						
	Approval					Date	
	G. Chaisson					8/1/75	Cross Reference

The following documentation, describing the technical characteristics of the PDP-14, may be ordered through the Field Service Information Center, Maynard. This service is available to DEC Field Service Personnel only.

Designation

Description

PDP-14K

PDP-14 Print Set, including:

- a) PDP-14 prints and module utilization
- b) DA14L prints
- c) DA14I prints
- d) BX 14-DA prints
- e) BY14-DA prints
- f) BF 14-H prints
- g) BF14-F prints
- h) BA14 prints
- i) MR14 prints
- j) 7006314 prints (power filter assembly)
- k) BK272 prints
- l) BK232 prints
- m) BK302 prints
- n) BC14-A prints
- o) MM14-A prints

PDP-14 Software Kit

Documentation and Program package shipped with every PDP-14, including:

- a) Maintenance Manual, Vol I & II
- b) User's Manual
- c) Control Handbook (latest printing)
- d) PDP-14 Instruction Reference Card
- e) Tapes and program documents for:
 - PAL-14
 - SIM-14 (Used in maintenance)
 - Set-14
 - Bool-14
 - Load-14 (Used in maintenance)
 - Run-14
 - VER-14 (MAINdec)
 - Test-14 (MAINdec)
 - Test-14/L (MAINdec)
 - ABE-14 (MAINdec)
- f) Control Program Development Instructions

COMPANY CONFIDENTIAL

digital	FIELD SERVICE TECHNICAL MANUAL				Option or Designator
	12 Bit <input checked="" type="checkbox"/>	16 Bit <input type="checkbox"/>	18 Bit <input type="checkbox"/>	36 Bit <input type="checkbox"/>	PDP-14

Title DOCUMENTATION LIST				Tech Tip Number PDP-14-TT-2		
All	Processor Applicability			Author C.F. Silva	Rev A	Cross Reference
	14			Approval G. Chaisson	Date 8/1/73	

DESIGNATION

DESCRIPTION

Maintenance Manual	Controller Theory, Block Diagrams, and Drawings. Copyright 1972.
Users Manual	Operating Instructions Including a) Installation Procedures b) Programming Instructions c) Maintenance Instructions d) Specifications Copyright 1972
Control Handbook	Guide to solid state control logic
PDP-14 Reference Card	Shirt pocket size instruction card and program operating guide (brief)
PDP-14 Engineering Note #1	Use of SIM-14 in a PDP-14/PDP8 system
PDP-14 Engineering Note #2 revised edition	Connecting the PDP-14/14L to the PDP8/8I/8L/8E/12 and LINC-8.
PDP-14 Engineering Note #3	K614 Output drive. Fuse data
PDP-14 Engineering Note #4	PDP-14 Severe Environment Kit
PDP-14 Engineering Note #5	PDP-8/E to PDP-14 Serial interface PDP-8 Bus expander for multiple PDP-14 interface
PDP-14 Engineering Note #6	BF 14 storage module and its use in the PDP-14
PDP-14 Engineering Note #7	Noise Immunity within the PDP-14
PDP-14 Engineering Note #8	Accessory Box Component and use.

COMPANY CONFIDENTIAL

Title						Documentation List		Tech Tip		PDP-14-TT-2	
All						Processor Applicability		Author		Rev	
14								C. E. Silva		A	
						Approval		G. Chaisson		Date 8/1/73	
										Cross Reference	

PDP-14 Engineering Note #9	Counting and Shift Register Functions
PDP-14 Engineering Note #10	PDP-14 and PDP-14L installation guide
PDP-14 Engineering Note #11	ROL-14
PDP-14 Engineering Note #12	Standard DC I/O for the PDP-14 and 14L
PDP-14 Engineering Note #13	Transition Monitoring Interface
PDP-14 Engineering Note #14	PDP-11 to PDP-14 Serial Line Interface
PDP-14 Engineering Note #15	Read/Write Memory
BT14-A Handout	BT14-A Interrogator Box Instructions
DEC-ECO-LOG	Synopsis of every ECO and FCO issued for the PDP-14
ECO/FCO Copies	Detailed instructions for completing the "Field Effective" PDP-14 ECO's Listed in the DEC-ECO-LOG.
PDP-14 Tech Tips	Maintenance Tips for the PDP-14
Prints	Prints for all modules forwarded to the field.

COMPANY CONFIDENTIAL

digital	FIELD SERVICE TECHNICAL MANUAL				Option or Designator
	12 Bit <input type="checkbox"/>	16 Bit <input type="checkbox"/>	18 Bit <input type="checkbox"/>	36 Bit <input type="checkbox"/>	PDP-14

Title				Tech Tip	
ECO/FCO LIST				Number PDP-14-TT-3	
All	Processor Applicability			Author	Rev
	14			L. Goelz	0
			Approval	Date	Cross Reference
			G. Chaisson	9/12/72	

Equipment	ECO Change	Priority	Units Affected	Purpose	Indication of Accomplishment
PDP-14	14-00019	optional unless more than 256 inputs are desired, then <u>MANDATORY</u>	PDP-14 S/N 84 and below	Adds wire wrap to increase available inputs to 512	Presence of wire from D29D2 to D30D2, or PDP-14 is S/N 85 or higher
	14-00029	Optional unless using DB14, then <u>MANDATORY</u>	PDP-14 S/N 57 & Prior but only using DB14	Alters +12V power supply in power filter	Looking at the power filter with the PDP-14 extended on its hinges, the 5-lug terminal strip just to the side of the convenience outlet has no components mounted on it (diodes D1 & D2, resistor R1, capacitor C1).
	14-00031	optional unless using DB14, then <u>MANDATORY</u>	PDP-14 S/N 57 and below	adds wire wrap to enable use of DB14	Presence of wire from A19M1 to A21S2, or PDP-14 is S/N 58 or higher

Note: ECO 14-00029 is not F-coded, however, if a customer requires use of a DB14 with a PDP-14 not having ECO 14-00029 accomplished, the effect of this ECO can be achieved by a field alternation at customers expense. Contact Product Support for details in this uncommon case.

Note: ECO 14-00031 is not F-Coded, however, if a customer requires use of a DB14 with a PDP-14 not having ECO 14-00031 accomplished, this ECO may be field installed at customers expense.

COMPANY CONFIDENTIAL

Title ECO/FCO List (Continued)						Tech Tip Number PDP14-TT-3		
All	Processor Applicability					Author L. Goelz	Rev 0	Cross Reference
	14					Approval G. Chaisson	Date 10/17/72	

<u>Equipment</u>	<u>ECO Change</u>	<u>Priority</u>	<u>Units Affected</u>	<u>Purpose</u>	<u>Indication of Accomplishment</u>
	14 00037	MANDATORY	All PDP-14 units having machine shut down problems possibly caused by radiated EMI	Removes shut down L signal run	There is no wire from C32M2 to D32M2
PDP-14	14 00039	MANDATORY	All PDP in PDP-14 14 con- units using troller PDP-8E or M742 rev F boards	Adds wire wrap to enable use of PDP-8E Rev F board & adds M249 for PDP-8E interface	Presence of wire from B18N1 to A22L2
			NOTE:	ECO 14-00039 has a typing error on the first page; under "Correction" the line reading	
				EXT MODE (1) H - B18N1 - A22L1 should read	
				EXT MODE (1) H - B18N1 - A22L2	
PDP-14	14 00043	MANDATORY	14 Units in 14 units shipped using the before DC14 option (serial line interface)	Adds wires to allow use of DC14 option	There is wire installed from A19B2 to A21D1

COMPANY CONFIDENTIAL

PAGE 530	PAGE REVISION 0	PUBLICATION DATE Oct. 1972
----------	-----------------	----------------------------

digital	FIELD SERVICE TECHNICAL MANUAL				Option or Designator
	12 Bit <input checked="" type="checkbox"/>	16 Bit <input type="checkbox"/>	18 Bit <input type="checkbox"/>	36 Bit <input type="checkbox"/>	PDP-14

Title ECO/FC LIST (continued)				Tech Tip Number	
All Processor Applicability				Author	Rev
14				L. Goelz	A
				Approval	Date
				G. Chaisson	8/10/73
					PDP-14-TT-3 Cross Reference

NOTES: * FCO 13-C0043 revision B should be used for field installation of ECO14-00043

** Engineering specifications describing field installation have been issued under document number DC14-0-2

*** FCO M742-C0005 and FCO M741-C0003 are required for use of the DC14 option.

Equipment	ECO Change	Priority	Units Affected	Purpose	Indication of Accom.
PDP-14	14 00050	As required replace 714 on an as fails basis with an H742 supply	All PDP 14's	Provides a more reliable power supply for the PDP- 14	When 714 supply fails it is re- placed with an H752 supply.
PDP-14	14 00052	MANDATORY IN PDP-14 units having I- boxes plugged into row D of PDP-14	PDP-14 units shipped before 5-30-72	Connects row C and row D load equal 3" signal runs	There is a wire install from C32E2 to D32H2
PDP-14	14 00053	Mandatory in all PDP-14 using DL14	All PDP- 14 using DL14	Enable use of DL14	
PDP-14	14 00054	Mandatory if MM14A is installed	All PDP- 14 using MM14A	Enable use of MM14A Read/ Write memory	
PDP-14	14 00055	As required Large PDP-14 systems	All PDP- 14's that require a third H752 power supply	Adds power supply to increase available power	

Title ECO/FCO LIST (continued)						Tech Tip Number PDP14-TT-3		
All	Processor Applicability					Author L. Goelz	Rev A	Cross Reference
	14					Approval G. Chaisson	Date 8/10/73	

Equipment	ECO Change	Priority	Units Affected	Purpose	Indication of Accomplish
M741 (Major States)	M741 00002	Low	All etch Rev. C. M741 modules	Lowers impedance of signal	R3 is 470 ohms, see Maint.Man. Vol. II, Page 8 Fig.II-7 for M741 etch Rev.C. layout.
	M741 00003	Mandatory	All etch Rev.C. M741 modules	Eliminates timing	Q3 and Q5 are DEC 6531, see Maintenance Manual Vol. II, Page 8 Figure II-7 for M741 etch Rev.C layout

NOTE: M741 etch revision A or B or C (with ECO M741 00003 completed) will function properly in the PDP-14, However, the PDP-14L requires an M741 etch Rev. C with ECO M741-00003 accomplished.

	M741 00004	Mandatory on all PDP14 using MM14A	All etch Rev. C M741 modules	Corrects timing for MM14A	1K resistor between +5VDL and BP1
M742 (Pwr)	M742 00003	Mandatory	PDP-14 Rev.E & lower	Clears outputs	M742 is etch Rev. F or higher.

COMPANY CONFIDENTIAL

PAGE 532	PAGE REVISION A	PUBLICATION DATE
----------	-----------------	------------------

digital	FIELD SERVICE TECHNICAL MANUAL				Option or Designator
	12 Bit <input checked="" type="checkbox"/>	16 Bit <input type="checkbox"/>	18 Bit <input type="checkbox"/>	36 Bit <input type="checkbox"/>	PDP-14

Title ECO/FCO LIST (continued)				Tech Tip Number PDP-14-TT-3		
All	Processor Applicability			Author	Rev	Cross Reference
	14			L. Goelz Approval G. Chaisson	A Date 8/10/73	

Equipment	ECO Change	Priority	Units Affected	Purpose	Indication of Accomplish
42 (Pwr) Control	M742 00005	Mandatory in systems to be used with the DC14 or DL14 option	All PDP-14 system using the DC14 or DL14 option.	Lengthens timing of DC14 halt detection time to 600Micro seconds	R28 is 47 KOHM, ref FCO M742 C00005
M742 (K inter face)	M743 00001	Mandatory systems with I-boxes plugged into row D or where the instr. CLR fails to clear all outputs	M743 modules shipped before 3-6-72	Provides higher current output to CLR I/O L signal line	R24 is 100 OHms ref. FCO M743-C00001
M745 (8 family interface)	M745 0000	Mandatory for systems interfaced to PDP-8E or DB14	Units interfaced to PDP-8E	Allows use of PDP-8E	M745 is etch Rev.E or above.

NOTE: An M745 etch revision E must be used in all PDP-14 backframes which contain an M249.

COMPANY CONFIDENTIAL

Title ECO/FCO LIST (Continued)						Tech Tip Number PDP-14-TT-3	
All		Processor Applicability		Author L. Goelz		Rev 0	Cross Reference
14						Approval G. Chaisson	Date 9-11-72

M774 Instru- ction decoding PDP-14L	M774 00001	MANDATORY	M774 etch Rev. C	insures initial signal on power dip.	M774 is etch Rev.C Q3 is DEC 2219, R16 is 22 OHM (see physical layout next page)
---	---------------	-----------	------------------------	--	---

NOTE: No M774 less than etch revision C should be used in the field.

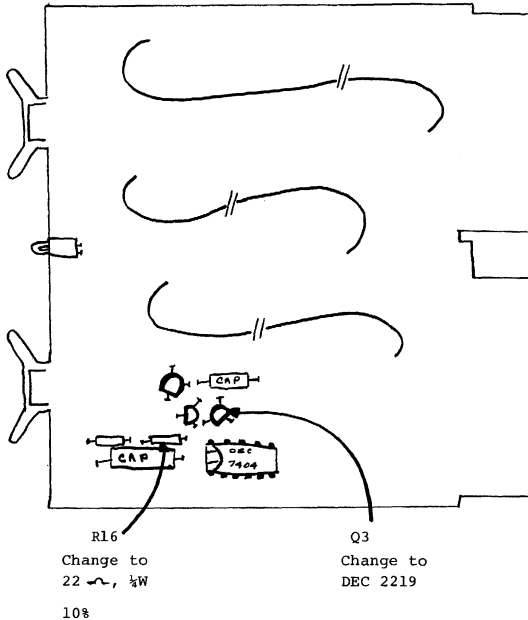

- FIGURE 1-M774-A -

COMPANY CONFIDENTIAL

DIGITAL EQUIPMENT CORPORATION

digital	FIELD SERVICE TECHNICAL MANUAL				Option or Designator
	12 Bit <input checked="" type="checkbox"/>	16 Bit <input type="checkbox"/>	18 Bit <input type="checkbox"/>	36 Bit <input type="checkbox"/>	PDP-14
Title GUIDE TO PDP-14 MODULE USAGE					Tech Tip Number PDP14-TT-4
Author L. Goelz	Rev B			Cross Reference	
Approval G. Chaisson	Date 01/24/73				

A. MODULE REPLACEMENT GUIDE

K136 - Implemented by ECO BX14-DA-00007 - used in BX-DA (I-Box AC), BX14-DD (I-Box DC), and BX14-SA (I-Box Schmitt Trigger) options. The K136 replaces the K135 in the above options. Due to the fast response time of the K135, transients from the K578 could be coupled through the K135. The K136 can be used to replace K135's in any option. Do not replace K136's with K135's.

M249 - Implemented by ECO PDP-14-00039 - used when the PDP-14 is interfaced to an PDP-8E. The M249 contains extra buffer stage due to the accumulator in the PDP-8E not being available all the time. The M249 can be used as a replacement for the M106. (Used when PDP-14's are interfaced to a PDP-8I, 8L.) Do not replace an M249 with an M106 if the system uses a PDP-8E or has the DL14 option installed. The DL14 option, although it can use a PDP-8I, 8L must have an M249 installed. When an M249 is utilized the M745 must be revision E or above.

M7400 - Implemented by ECO PDP-14-00051 - used when a system contains the DL14 option. This module decodes more instructions than the M740 and eliminates the halt instruction (0007). The M7400 may be used to replace an M740 but under no circumstances should an M740 be used as a replacement for the M7400.

M7450 - The M7450 is used to replace the M745 when the DL14 option is implemented. The M7450 decodes more instructions than the M745. It can be used to replace any M745. An M745 can be used in a PDP-14 that has the DL14 option wired but without the option modules installed.

M921 - When the DC14 option is used the jumpers on this module must be changed. Reference print BS-DC14-A-1 for jumper connections.

K161 - If other than revision "D" or above is used, and the user experiences the situation where he has inputs being on but the program tests them as being off, then the solution to the problem may well be changing the older rev. boards with Rev. "D" modules.

COMPANY CONFIDENTIAL

Title GUIDE TO PDP-14 MODULE USAGE						Tech Tip PDP-14-TT-4 Number		
All	Processor Applicability					Author L. Goelz Rev B		Cross Reference
	14					Approval G. Chaisson Date 5/2/73		

B. MODULE REVISION AND APPLICABILITY GUIDE

MODULE	ETCH	REV.	CS REV.	NOTE
M106	A			See module replacement guide under M249.
M232	A			Used on any PDP-14
M235	A			Used on all PDP-14L's
M249	A			See module replacement guide
M589	A		B	Used on all DC14 options
M740	A			See module replacement guide under M7400
M741	D		D	Rev. D is required for PDP-14's which have MM14A option installed. Rev. C can be used on all other PDP 14's providing ECO's M741-00002, 3 have been accomplished. Do not use a lower revision board.
M742	F		J	Used on all PDP-14's. Do not use a lower revision board.
M743	A		A	Used on all PDP-14's
M744	F		J	Use any revision for PDP-14's
M745	E			Use this revision on all PDP-14's interfaced to PDP-8E or when an M249 is used. Earlier revisions are usable when M249 is not used. See module replacement guide under M7450.
M746	A		B	Used on all PDP-14's
M747	A			Used on all PDP-14's
M748	D		C	Used on all PDP-14's which utilize the DC-14 option.

COMPANY CONFIDENTIAL

PAGE 536	PAGE REVISION	PUBLICATION DATE
----------	---------------	------------------

digital	FIELD SERVICE TECHNICAL MANUAL				Option or Designator
	12 Bit <input checked="" type="checkbox"/>	16 Bit <input type="checkbox"/>	18 Bit <input type="checkbox"/>	36 Bit <input type="checkbox"/>	PDP-14

Title					Tech Tip	
GUIDE TO PDP-14 MODULE USAGE					Number PDP-14-TT-4	
Processor Applicability			Author	Rev	Cross Reference	
All	14		L. Goelz	B		
			Approval	Date		
			G. Chaisson	5/2/73		

MODULE	ETCH REV.	CS REV.	NOTE
M749	A		Used on all PDP-14's which utilize the DC-14 option.
M7400	B	A	See module replacement guide.
M7403	D	D	Used on all DL-14 options.
M7404	E	D	Used on all DL-14 options.
M7405	C	C	Used on all DLL4 options.
M7407	D	D	Used on all MML4 options.
M7450	B	B	See module replacement guide
M774	C	C	Must use etch revision C or above on all PDP-14L's with ECO-M774-0001 accomplished.
M8332	C	D	Used on all DC14 options (Interface to 8)
M8333	D	C	Used on all DC14 options, replacing earlier revisions on an as fails basis. Caution should be used when the change is made, for the customer may have to correct his status word handling. The earlier diagnostic will not operate with the new revision modules.
M589	A	B	Used on all DC14 options.
M8334	D	C	Used on all DC14 options. (INTFC to 11)
G922			Any revision is used the PDP-14
G923			Any revision is used in the PDP-14
G924			Any revision is used in the PDP-14
K022	A		Used in BA14 option
K135	A		See module replacement guide under K136
K136	E	D	See module replacement guide
K161	D	D	Used on all BX14 and BY14 options.
			See module replacement guide.
K207	C	D	This module can be utilized in all I and O boxes providing the board was not constructed using griplets. If a board with griplets is used, it may become intermittent.
K272	B		Used on BA14 option.
K274	A		Used on BA14 option. There is a potential failure on power down retention if the board contains

Title GUIDE TO PDP-14 MODULE USAGE (Continued)						Tech Tip Number PDP14-TT-4		
All	Processor Applicability					Author Larry Goelz	Rev A	Cross Reference
	14					Approval G. Chaisson	Date 01/25/73	

B. MODULE REVISION AND APPLICABILITY GUIDE (Continued)

MODULE	ETCH REV.	CS. REV.	NOTES
			E.A.C. relays (green). The preferred relay in one manufactured by Babcock.
K302	A		Used on BA14 options.
K564	B	B	Used on BX14-DD option.
K578	B	A	Used on BX14-DA option; revision B is a preferred replacement if input noise or conversion time is a problem.
K579	C	D	Used on BX14-DA option and where Goriner free AC inputs are required. The I-box must have ECO BX14-DA-0008 accomplished in order to utilize this module.
K614	D	F	Used on BY14-DA option. Must have ECO K614-0007 installed.
K616			Used on BY14-DA options. A low current AC output, operates to 10MA AC load.
K657	B	A	Used on BY14-DD options.
PDP14 Power Supply			H752 - replace existing power supplies H752 on an as fails basis (Ref. ECO PDP14- 0050)
PDP14L Power Supply - H726			Any revision may be used. Part # 12-9033-01. Do not order or use H726E - this is a different supply.

COMPANY CONFIDENTIAL

digital**FIELD SERVICE TECHNICAL MANUAL**

Option or Designator

12 Bit 16 Bit 18 Bit 36 Bit

PDP-14

Title

H752 POWER SUPPLY ADJUSTMENT

Tech Tip

Number PDP14-TT-5

All

Processor Applicability

Author L. Goelz

Rev 0

Cross Reference

14

Approval G. Chaisson Date 10/18/72

Field adjustment of the H752 power supply is accomplished by placing the supply under a load (7 amp to 7.5 amp) and adjusting R9 on the power supply for $5.15V \pm .050V$. A typical load can be constructed using resistors; i.e., six (6) 4 ohm 10 watt resistors give approximately a 7.5 amp load. (See Figure 1.)

This adjustment procedure is to be accomplished on one power supply at a time. In cases where two supplies are connected in parallel, the +5V and sense connections between the supplies must be disconnected when making the adjustments.

When operating the supplies in parallel, it is essential that both supplies be adjusted to the proper value. Not having both supplies properly adjusted may cause the loss of one supply.

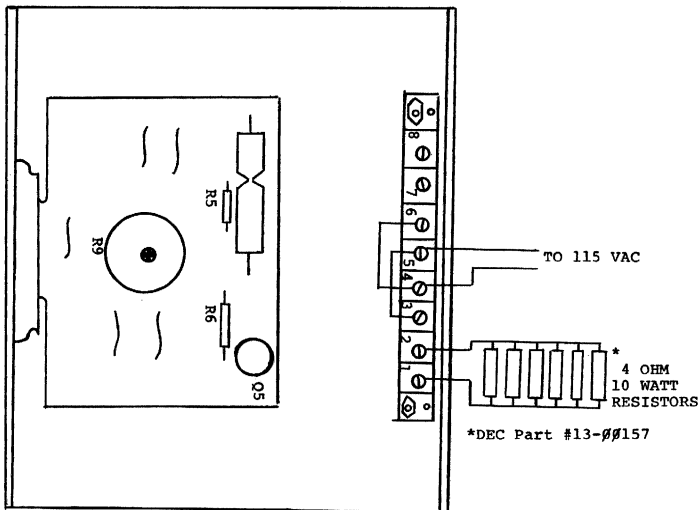

H752

FIGURE 1**COMPANY CONFIDENTIAL**

Title EXCESSIVE LOADING ON DUAL POWER SUPPLY SYSTEMS				Tech Tip Number PDPl4-TT-6		
All	Processor Applicability			Author Larry Goelz	Rev 0	Cross Reference PDPl4-TT-5
	14			Approval G. Chaisson	Date 01/19/73	

The possibility exists that some PDPl4 Systems are drawing in excess of 14 amps (current rating of Dual P/S system). Under this condition it is necessary to add a third H752 power supply to the system. The following procedure is to be followed to accomplish this:

1. Ensure ECO PDPl4-00055 has been accomplished; if not do it now using FCO PDP14-000055.
2. Check to see that all three supplies are adjusted properly; see "Cross Reference" above.
3. Mount the third H752 power supply externally, as close as possible, to the PDPl4 main frame.
4. Ensure jumpers are on the power supply from terminal 3 to terminal 5 and from terminal 4 to terminal 6. If these two jumpers are not present add them.
5. Using #14 gauge wire run the following wires:

<u>COLOR</u>	<u>FROM</u> (New Power Supply)	<u>TO</u> (Either of the two original power supplies)
RED	Terminal 3	Terminal 3
WHITE	Terminal 4	Terminal 4
RED	Terminal 7	Terminal 7
6. Run a #14 gauge RED wire from Terminal #1 of the new supplu to pin C27A2 and a #14 gauge WHITE wire from Terminal #2 to pin C27C2.

/mt

COMPANY CONFIDENTIAL

digital	FIELD SERVICE TECHNICAL MANUAL				Option or Designator
	12 Bit <input checked="" type="checkbox"/>	16 Bit <input type="checkbox"/>	18 Bit <input type="checkbox"/>	36 Bit <input type="checkbox"/>	PDP 14

Title AC INPUT POWER WIRING				Tech Tip Number PDP-14-TT-7		
All	Processor Applicability			Author Larry Goelz	Rev 0	Cross Reference
	14			Approval G. Chaisson	Date May 11, 1973	

All PDP 14's shipped are set up for 110vac operation. Where 220VAC operation is required, the power supply must be rewired by changing the jumper configuration as shown below and on the power supply.

	<u>110VAC</u>	<u>220VAC</u>
JUMPER TERM	- 3-5, 4-6	4-5
INPUT TERM	- 3, 4	3, 6

Title OPTION LOAD REQUIREMENTS				Tech Tip Number PDP-14-TT-8		
All	Processor Applicability			Author Larry Goelz	Rev #	Cross Reference
	14			Approval G. Chaisson	Date 7/30/73	

Listed below are the load requirements placed on the PDP14 power supply by the individual options.

Option	Load-amps
PDP14 main frame	2.0
BX14 DA	.175
BX DD	.500
BX SA	.500
BY14-DA	.550
DD	.680
SA	.680
BA 14	.300 (plus K302's and/or K274's)
K274	.100
K302	.020
BF14M	.135
MR14 (1K)	.500
DA14	.800
DC14 (in the PDP14)	1.00
DL14	1.350
MM14A (module)	.300

COMPANY CONFIDENTIAL

Title						Tech Tip	
OPTION LOAD REQUIREMENTS						Number PDP-14- TT-8	
All	Processor Applicability					Author	Rev #
	14					Larry Goelz	
						Approval	Date
					G. Chaisson	7/30/73	Cross Reference

Included in the DC14 option are two modules which are plugged into the PDP8 omnibus. The loads for these modules are:

M8332	.900 amp
M8333	1.000 amp

The PDP14 power supplies ratings are:

714	7 amp (Should be replaced with H752 when fails REF ECO PDP-14-00050)
H752	7 amps
H756	25 amps (Not avail. until 10/1/73)

Title						Tech Tip	
FREQUENTLY REQUESTED COMPONENTS NOT IN FIELD SERVICE SPARE PART BOXES						Number PDP-14-TT-9	
All	Processor Applicability					Author	Rev #
						Fred Silva	
						Approval	Date
					G. Chaisson	8/10/73	Cross Reference

Item	Part No.	PDP	Remarks
BC14C-10		Both	Test Equipment; see Tech Tip BC14C-TT-1
DEC6531	1509338	Both	For ECO M741-003
DEC846	19-9688	Both	For ROM Repair
Core,Wound	2918605	Both	For 6923 ROM repair
Core,Unwound	2918606	Both	For G922 ROM repair when used with G923
Fuse,5 amp	1209070	Both	Output Box fuses
Triac	1505564	Both	For module repair
Indicator			
Lights	1209337	Both	For module repair
MC3001P	19-9514	Both	For module repair
DEC7404	19-9686	Both	For module repair
DEC74H50N	19-9060	Both	For module repair
DEC74H40N	19-5586	14	For module repair
DEC74H00N	19-9056	14	For module repair
DEC4007P	19-9867	Both	For module repair
36 Gauge			
Wire	2918620	Both	For ROM repair
Core,wound	29-20902	Both	For G923YA ROM repair
Core,unwound	29-20903	Both	For G922 ROM repair when used with AG923YA

COMPANY CONFIDENTIAL

digital	FIELD SERVICE TECHNICAL MANUAL				Option or Designator
	12 Bit <input checked="" type="checkbox"/>	16 Bit <input checked="" type="checkbox"/>	18 Bit <input type="checkbox"/>	36 Bit <input type="checkbox"/>	PMK02

Title USING PMK02 WITH LA30 P ON PDP8E System				Tech Tip Number PMK02-TT-1		
All	Processor Applicability			Author Bruce Meier	Rev 0	Cross Reference
	BE			Approval Mike Kalagher	Date 9-21-72	

When using the PMK02 Field Service cassette tester on a system having a parallel LA30 as its console TTY (OP codes 03 and 04) the PMK02 interface (M865 or M8650) must have its OP codes modified. They should be changed to those of the first users TTY, OP codes (30). To enable programs in RIM Format to be read in the following changes must be made to RIM loader:

Address	From	To
7756	6032	6302
7757	6031	6301
7761	6036	6306
7767	6031	6301
7771	6034	6304

The following changes must also be made to enable binary format programs to be read in (these changes are for DEC-08-LBAB. Similar changes can be made to other revisions of binary loader).

Address	To
7662	6301
7664	6306
7701	6302

The above changes allow both console device interface and PMK02 interface to remain in the bus together.

Program running procedures and error type out will still be reported to the console device.

Title USING PMK02 WITH LA30 P ON PDP-11 System				Tech Tip Number PMK02-TT-2		
All	Processor Applicability			Author Bruce Meier	Rev 0	Cross Reference
	11			Approval Mike Kalagher	Date 9-21-72	

When using the PMK02 (Field Service Casette Tester) on a system having a parallel LA30 as its only keyboard I/O device the address and interrupt vector locations of the PMK02 Interface must be changed. The following changes assume that the LA30 is cut for console TTY address and interrupt vector locations.

- A. M780 Control
- Two additional modules must be on hand, M105 and a M782 (0) or M7821.

(CPL)

Title USING PMK02 WITH LA30 P continued						Tech Tip Number PMK02-TT-2	
Processor Applicability						Author Bruce Meier Rev 0	
All		11				Cross Reference	
ApprovMike Kalagher						Date 9-21-72	

2. Cut the M105 to an address of the first user TTY - 176500
3. Cut M782 (0) or M7821 to first available floating vector location.

B. M7800 Control

1. Cut Add and Vector jumpers to conform with 2 and 3 above.

To enable programs in absolute format to be loaded one program change must be made.

<u>Address</u>	<u>From</u>	<u>To</u>
*776	I77560	I76500

*depending on core size

Diagnostic running procedures and error type out will still be reported on the console device.

COMPANY CONFIDENTIAL

digital	FIELD SERVICE TECHNICAL MANUAL				Option or Designator
	12 Bit <input checked="" type="checkbox"/>	16 Bit <input type="checkbox"/>	18 Bit <input type="checkbox"/>	36 Bit <input type="checkbox"/>	PP8I

Title PP8I SYNCHRONIZATION PROBLEMS				Tech Tip Number PP8I-TT-1	
All	Processor Applicability		Author Art Fuller	Rev 0	
	8I		Approval W. Cummins	Date 7-31-72	
			Cross Reference		

If erratic punch operation suggests the possibility of the logic for synchronization being at fault, the following procedure will guide you in making a determination. The procedure for mechanical synchronization in the Roytron maintenance manual may also be helpful.

Signal SYNC PUN at pin F on the W033 connector at the rear of the punch (or H2BV2 - M710) should hold at +2 volts with punch power off. With power on, the signal should be as shown below.

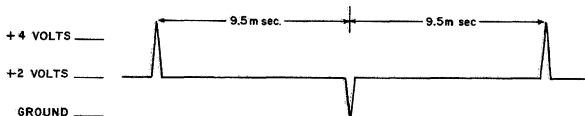

If this signal is not as described, the following steps are suggested:

- 1) Check to see that +5 volts is present at pin V of the W033 connector at the rear of the punch.
- 2) Disconnect the W033 connector. There are two identical coils on the front left of the punch which should be checked; readings of about 500 ohms should be obtained from both pin F to V and pin F to ground.

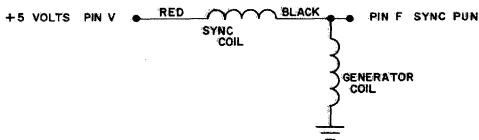

- 3) The gap between the coil head and core wheel should be checked; a piece of paper tape may be used as a reasonable gauge for checking the clearance.

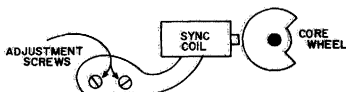

continued on
page 6

Title		PP8I SYNCHRONIZATION PROBLEMS (Continued)				Tech Tip Number		PP8I-TT-1	
All	Processor Applicability				Author	Rev		Cross Reference	
	8I				Art Fuller	0			
					Approval	Date			
					W. Cummins	7-31-72			

- 4) If the previous steps fail to suggest a solution, it is possible that the coil core may have become demagnetized. Proceed as follows:
- a) Turn off all power.
 - b) Remove red wire from pin V and black wire from pin F.
 - c) Note that PDP-8 and PDP-8I require opposite polarization in this step: For PDP-8I, make temporary connections of the red wire to ground, pin C and the black wire to -30 volts, pin D. For PDP-8, make temporary connections of the black wire to ground, pin C and the red wire to -30 volts, pin D.
 - d) Bring up power momentarily, then shut down; current flow thru the coil will remagnetize the core.
 - e) The 30 volt circuit does not include a bleeder resistor; as a result a charge will remain on the 30 volt line for some time. To avoid the possibility of discharging it thru the logic, it is suggested that the 30 volt supply be disconnected from the PC8I at the terminal strip on the rear panel before proceeding.
 - f) The coil leads can now be removed from terminals C and D and returned to their original positions, red to V and black to F.
 - g) Reconnect the 30 volt supply lead to the rear of the PC8I and recheck the SYNC PUN output again.
 - h) If the SYNC PUN signal remains below an acceptable level it may be that the coil assembly is defective. If placing a screwdriver blade against the exposed core end causes a significant rise in output level, it is an indication that the assembly should be replaced.

Arthur Fuller

COMPANY CONFIDENTIAL

digital	FIELD SERVICE TECHNICAL MANUAL				Option or Designator PR8I
	12 Bit <input checked="" type="checkbox"/>	16 Bit <input type="checkbox"/>	18 Bit <input type="checkbox"/>	36 Bit <input type="checkbox"/>	

Title PR8I Steps with Power Up and Start				Tech Tip Number PR8I-TT-1	
All 8I		Processor Applicability		Author Chuck Sweeney Rev 0	
		Approval W. Cummins		Date 7-31-72	
Cross Reference					

The logic by which tape is moved one character position during power up and by START is explained as follows. The circuit design of the A and B flip-flops is such that they come up in the 0 state. This condition generates STOP ENABLE which will set the ENABLE flip-flop because STOP COMPLETE is present. STOP COMPLETE is generated 40 msec after the INITIALIZE pulse which zeros the ENABLE flip-flop. ENABLE (1) qualified the clock which pulses a cycle of the A & B flip flops in the usual manner to step a character which is read into the reader buffer but not into the AC.

Title M715 and G908 Adjustments PR8I (not PC04)				Tech Tip Number PR8I-TT-2	
All 8I		Processor Applicability		Author C. Sweeney Rev 0	
		Approval B. Cummins		Date 7-31-72	
Cross Reference					

With the reader FEED switch depressed, pulses at H27U2 should be at intervals of 1.67 msec. The lower pot on the M715 should be adjusted for correction.

Load the following test program:

7001	6014	7005	5204
7002	6011	7006	5201
7003	5202	7007	0000
7004	2207		

With the program running and no tape in the reader, check to see that the sprocket wheel is not stepping. If it is stepping that indicates the probability that the feed hole gain of the G908 is set too low; a clockwise adjustment of the pot on the G908 should correct this. Insert a ones/zeros tape in the reader. If the reader does not move tape, that indicates the probability that the feed hole gain of the G908 is set too high; a counter-clockwise adjustment of the pot on the G908 should correct this. The proper adjustment for that pot is midway between the two failure conditions.

Once the G908 is adjusted correctly the M715 adjustment can be continued. With the program running, the required signal at H27U2 is 3.5 msec between the first and second pulses in the group of three. The upper pot on the M715 should be adjusted for correction.

COMPANY CONFIDENTIAL

Title PR8I HIGH SPEED READER TEST ERRORS				Tech Tip Number PR8I-TT-3		
All	Processor Applicability			Author C. Sweeney	Rev 0	Cross Reference
	8I			Approval W. Cummins	Date 7-31-72	

Maindec 08-D2FC-Part 2 will fail with an indication of error when actually there is none. The constant, M377, in location 0020 should be changed to 0000 to eliminate the problem.

If the system includes an AX08 option, there will be an additional problem in that the test includes an AX08 IOT instruction 6377 at location 0305. The contents of location 0305 should be an NOP-7000. The later program 08-D2GC has eliminated this problem,

Title PR8I MODULE AND MAINDEC REVISIONS				Tech Tip Number PR8I-TT-4		
All	Processor Applicability			Author Chuck Sweeney	Rev 0	Cross Reference
	8I			Approval W. Cummins	Date 7-31-72	

EC08I-00008 documents the use of specific revision M705 and M715 modules in the PR8I. There are only two combinations which are acceptable:

	M705 Revision	M715 Revision	ECO 8I-00008	Maindec
1	C	A	Not installed	08-D2FC
2	D	C	Installed	08-D2GC

digital	FIELD SERVICE TECHNICAL MANUAL				Option or Designator
	12 Bit <input checked="" type="checkbox"/>	16 Bit <input type="checkbox"/>	18 Bit <input type="checkbox"/>	36 Bit <input type="checkbox"/>	PR8I

Title				Tech Tip	
ADJUSTMENTS on M715 and G908				Number PR8I TT#5	
All Processor Applicability		Author	W. Freeman	Rev	0
8I		Approval	W. E. Cummins	Date	12/5/73
					Cross Reference

With the reader FEED switch depressed, pulses at H27U2 should be at intervals of 1.67 msec. The lower pot on the M715 should be adjusted for correction.

Load the following test program:

7001	6014
7002	6011
7003	5202
7004	2207
7005	5204
7006	5201
7007	0000

With the program running and no tape in the reader, check to see that the sprocket wheel is not stepping. If it is stepping that indicates the probability that the feed hole gain of the G908 is set too low; a clockwise adjustment of the pot on the G908 should correct this. Insert a ones/zeros tape in the reader. If the reader does not move tape, that indicates the probability that the feed hole gain of the G908 is set too high; a counter-clockwise adjustment of the pot on the G908 should correct this. The proper adjustment for that pot is midway between the two failure conditions.

Once the G908 is adjusted correctly the M715 adjustment can be continued. With the program running, the required signal at H27U2 is 3.5 msec between the first and second pulses in the group of three. The upper pot on the M715 should be adjusted for correction.

COMPANY CONFIDENTIAL

NOTES

digital	FIELD SERVICE TECHNICAL MANUAL				Option or Designator
	12 Bit <input checked="" type="checkbox"/>	16 Bit <input type="checkbox"/>	18 Bit <input type="checkbox"/>	36 Bit <input type="checkbox"/>	PP67

Title				PP67A/B TYPESETTING PUNCH		Tech Tip Number		PP67-TT-1	
All		Processor Applicability		Author		Rev		Cross Reference	
8's				John Gleeson		0			
				Approval		Date			
				W. Cummins		7-31-72			

INTRODUCTION:

The PP67 punch is an adaptation of either the Teletype BRPE11 punch or the BRPE18 punch, the BRPE11 being an 8 level punch and the BRPE18 a 6 level punch. Both punches are originally built to operate at 50 characters/second, but are modified by DEC, to operate at 110 characters/second. The addition of a DEC assembly (part number 70-5095-control assembly) converts the punch to a PP67 (6 or 8 level dependent on the use required).

PERTINENT DOCUMENTS:

PA60, PA61, PP67 Prints; DEC-08-17TA-D, BRPE Punch Manual - 215B and 1154B.

CONTROL SWITCH:

On top of the punch is a four (4) position switch. The four positions have the following significance:

"AVAILABLE" - in this position switching on or off of the punch motor is under processor control. On the side of the punch is an adjustable micro-switch operated by an arm which rests on the tape spool. When the spool is reduced to a certain diameter ("Tape Low"), dependent on the setting of the micro-switch, the arm operates the micro-switch and signals a PUNCH NOT AVAILABLE condition which can be gated into the processor using an IOT instruction.

"STOP WHEN DONE" - in this position simulates a "TAPE LOW" condition. Since the Typesetting Program only checks for availability before commencing to punch, it would be possible to commence a "take" punch out just before the tape low condition and then run out of tape if the "take" was a long one. If a monitor should notice that this condition may occur shortly, he can switch the punch from "available" to "Stop When Done" while a tape is being punched which would allow the "take" to be finished, but then prevent any further "takes" from being routed to this punch.

"CONTINUOUS" - in this position the punch motor is turned ON but the punch is inhibited from processor control, PUNCH NOT AVAILABLE condition being signalled.

"OFF" - in this condition, the punch motor is turned OFF and the PUNCH NOT AVAILABLE condition is signalled.

COMPANY CONFIDENTIAL

Title						Tech Tip	
PP67A/B TYPESETTING PUNCH						Number PP67-TT-1	
All		Processor Applicability		Author John Gleeson		Rev 0	
8's				Approval Bill Cummins		Date 7-31-72	
Cross Reference							

NOTE: On the side of the punch is a toggle switch which can be used to switch on the motor irrespective of the position of the switch on top of the punch. This switch is for maintenance purposes only and it is recommended that the customer be advised to use switch on top of the punch when replacing tape in the punch, since if the switch is left in the "Available" position, a "take" could still be routed to the punch and lost if the customer is in the process of changing tape.

THEORY OF OPERATION

Control Circuit (See Diagram 1)

Point A, the junction of R3, R4 is at -3V. Assuming the switch in the "Available" position, before the "MOTOR START" signal is sent to the punch, point B is also at -3V hence the transistor is cut off and there is no volt drop applied across the wheelock relay. The SCR in the motor circuit has no control voltage applied to it and is therefore turned "off" (see note 1). When a MOTOR START is sent to the punch, point B goes to ground, the transistor turns on and the wheelock relay operates, closing point D. As the first half cycle of the 110 volt supply builds up across R1/R2 a voltage develops at point C which is applied as a control voltage to the SCR. The SCR turns "on" and current flows in the motor circuit driving the motor. As the first half cycle finishes, the anode voltage of the SCR reduces to zero, hence, the SCR turns off, but the second half cycle again develops a control voltage at Point C hence the SCR turns on again. Thus while the wheelock switch is operated the motor runs. When the MOTOR START signal is removed, the transistor cuts off; the wheelock switch opens and hence no further control voltage can be applied to the SCR. The SCR therefore turns off and remains off until the next MOTOR START signal is applied.

While the punch has sufficient tape in it, point F is at approximately -3.4 volts, R5 being connected in series with a 470 ohm resistor in the interface (Diagram 2), hence in this condition PUNCH AVAILABLE is signalled via pin 21 of the amp plug. When the TAPE LOW switch operates, a ground is signalled. The condition is also signalled by turning the punch switch to STOP WHEN DONE, CONTINUOUS or OFF. In the CONTINUOUS position, though, a ground is also applied to the transistor, point B, hence the motor runs continuously.

Operation of the toggle switch provides a direct supply to the motor, hence, the motor runs continuously irrespective of the position of the punch switch.

In the "OFF" condition an SCR has a high resistance in both directions (example 100,000 ohm), the gate to cathode being equivalent to a small diode. Providing the anode voltage is positive with respect to the cathode, if a small positive voltage (example 1V) is applied to the



digital	FIELD SERVICE TECHNICAL MANUAL				Option or Designator
	12 Bit <input checked="" type="checkbox"/>	16 Bit <input type="checkbox"/>	18 Bit <input type="checkbox"/>	36 Bit <input type="checkbox"/>	PP67

Title PP67A/B TYPESETTING PUNCHES (Continued)				Tech Tip Number PP67-TT-1	
All	Processor Applicability	Author John Gleeson	Rev 0	Cross Reference	
8's		Approval W. Cummins	Date 7-31-72		

gate, the forward resistance of the SCR will be greatly reduced and current will flow through the SCR. Once current is flowing, the SCR can only be turned off by removing the anode voltage.

Punch Solenoids (Dee Diagram 3)

Punch solenoids are driven from W040 solenoid drivers. One side of each solenoid is taken to -30V, the other side being taken to a W040. When a solenoid driver is selected, it lifts the discrete solenoid feed from -30V to ground, thus energizing the punch solenoid. In order that the solenoid drives are only driven at the correct point in the punch cycle, a reluctance pick-up situated on the brass disc forward of the motor shaft provides an output which is developed across a 1K 1/4 watt resistor with an 0.01 uf capacitor in parallel, in the punch interface, to supply a half enable input, to gate through the respective SELECT PUNCH level. The point in the punch cycle at which the output from the reluctance pick-up is provided can be varied by means of the "range-finder" (timing scale) situated at the front of the punch above the brass disc. This variation is provided to compensate for lengths of cable, signal delay, etc.

The diode across the solenoid is used for damping and the resistor is used to limit the current through the solenoid.

Adjustments:

All mechanical adjustments for the punch are detailed in the BRPE Technical Manual. Once these adjustments are made correctly, two (2) further checks need to be made:

- 1) Punching a series of alternate rubouts and tape feeds, hang a scope probe on the feed from the solenoid driver, at the punch solenoid, checking each solenoid in turn. The waveform should be as below:

The "glinch" should be positioned at the trailing edge of the sawtooth waveform (see below).

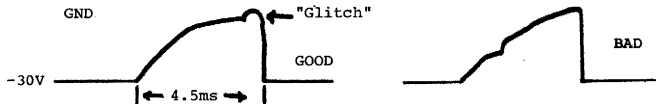

COMPANY CONFIDENTIAL

Title PP67A/B TYPESETTING PUNCH						Tech Tip Number PP67-TT-1	
All Processor Applicability			Author J. Gleeson		Rev 0		Cross Reference
g's			Approval W. Cummins		Date 7-31-72		

This can be achieved by slackening the two screws clamping the punch solenoid and adjusting the solenoid until the "glitch" is in the correct position. Make sure that when making this adjustment, the solenoid is moved squarely in the vertical direction. If **tilted**, the armature may slip out of the blocking pawl (see Diagram on page 13 of BRPE Manual Bulletin 215B). If small "glitch" is unobtainable, check the mechanical adjustments again, and, only as a last resort, adjust the tension on the solenoid armature spring.

2) Punching alternate 1's and 0's, slacken the screw holding the range finder and move the slide in one direction until punching begins to deteriorate: Note the position on the scale, then move the slide in the opposite direction until punching begins to deteriorate again and note the position on the slide. Set the range-finder at the midway point between the two positions and tighten the screw.

NOTE 1: If the scope probe is hung on the common feed at the solenoid, the waveform will look like



 -30V

NOTE 2: To check the feed hole solenoid, the program will have to contain a stall so that the solenoid is de-energized between punching of characters. The following program would be suitable for running while checking all solenoids:

2000/7604	SR = 0200
6314	LOAD ADD
7200	SRg-11=Punch N°
6026	START
6021	
5204	
2220	
5206	
7040	
5203	

COMPANY CONFIDENTIAL

Page -4-

digital	FIELD SERVICE TECHNICAL MANUAL				Option or Designator
	12 Bit <input checked="" type="checkbox"/>	16 Bit <input type="checkbox"/>	18 Bit <input type="checkbox"/>	36 Bit <input type="checkbox"/>	PP67

Title		PP67A/B TYPESETTING PUNCH (Continued)	Tech Tip Number	PP67-TT-1
All	Processor Applicability	Author	J. Gleeson	Rev 0
8's		Approval	W. Cummins	Date 7-31-72
				Cross Reference

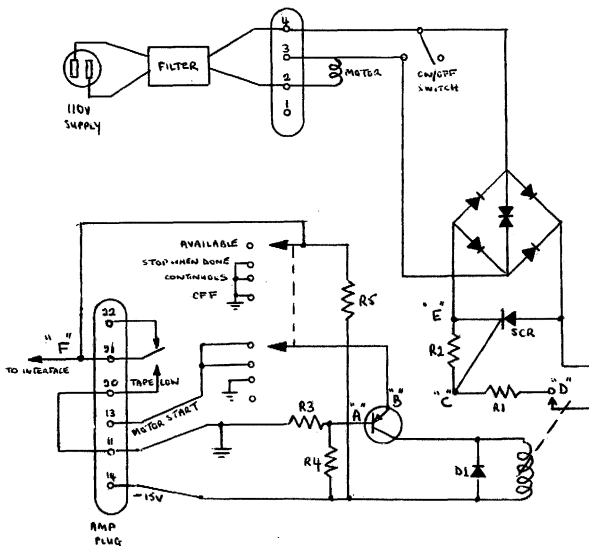
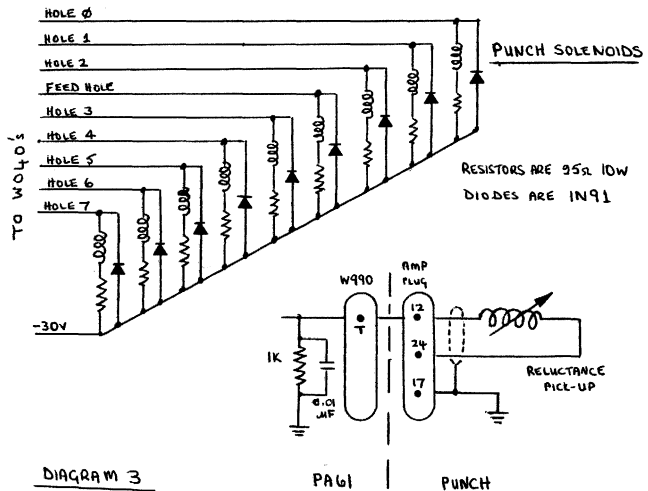
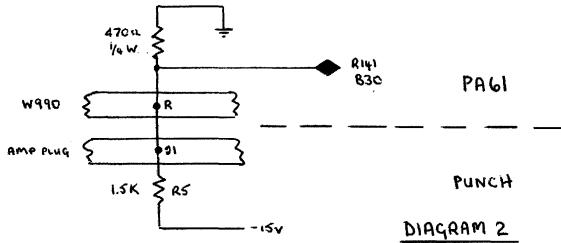

DIAGRAM 1 - PUNCH CONTROL

(Refer to Punch Control Schematic 7005095-0-1)

COMPANY CONFIDENTIAL

Title PP67A/B TYPESETTING PUNCH (Continued)						Tech Tip Number PP67-TT-1	
All Processor Applicability			Author J. Gleeson		Rev 0		Cross Reference
8's			Approval W. Cummins		Date 7-31-72		



COMPANY CONFIDENTIAL

digital	FIELD SERVICE TECHNICAL MANUAL				Option or Designator
	12 Bit <input checked="" type="checkbox"/>	16 Bit <input type="checkbox"/>	18 Bit <input type="checkbox"/>	36 Bit <input type="checkbox"/>	PP67

Title PP67A/B TELETYPE PUNCH (Continued)				Tech Tip Number	PP67-TT-1
All	Processor Applicability	Author John Gleeson	Rev 0	Cross Reference	
8's		Approval W. Cummins	Date 7-31-72		

DIAGRAM 4 - W990/AMP PLUG INTERCONNECTIONS

<u>W990</u>	<u>FUNCTION</u>	<u>AMP PLUG</u>
A	+10 V	15
B	-15V	14
C	GROUND	11 and 20
D	HOLE \emptyset	8
E	HOLE 1	1
F	HOLE 2	2
H	FEED HOLE	9
J	HOLE 3	3
K	HOLE 4	4
L	HOLE 5	5
M	HOLE 6	6
N	HOLE 7	7
P	MOTOR START	13
R	AVAILABLE	21
S	GROUND	12
T	SELECTED TIMING	24
U	GROUND	17
V	GROUND	16
	-30V SUPPLY IN INTERFACE	18

COMPANY CONFIDENTIAL

Title BRPE PUNCHES (PP67A,B,C,D)					Tech Tip Number PP67-TT-2	
All Processor Applicability			Author John Gleeson	Rev 0	Cross Reference	
8's			Approval W. Cummins	Date 7-31-72		

For correct operation at 110 characters/second on 50/60Hz systems, the following Motor/Gear sets are used:

- a) 60 hz 115V (Motor Speed - 3600 r.p.m.)

	TTY#	DEC #	
Motor Pulley	171190(44 teeth)	29-11299	} Part of modification kit, TTY #143044 (29-13817)
Motor Drive Gear	143052(24 teeth)	29-11197	
Belt	143055	29-11198	

The motor used is a model LMU3, with a 60 hz thermostatic switch TTY #122249, DEC #29-11148.

- b) 50 hz 115V and 230V (Motor Speed - 3000 r.p.m.)

Motor Pulley	147627(33 teeth)	N/A	} Part of modification kit, TTY #147624
Motor Drive Gear	147626(15 teeth)	N/A	
Belt	195448	N/A	

The LMU3 motor is also used for 50 hz systems, the changing of the gear set compensates for running the motor at 5/6 the normal speed (due to frequency). The supply for the punch is taken from a step-down transformer on 230V systems. The thermostatic switch used is a 50 hz switch TTY #193781, DEC #29-16808.

50/60 hz motors

The LMU3 motor is a synchronous motor, no manual variation of the speed being possible, hence, the requirement for different gear sets for 50/60 hz operation. Some punches, however, have been equipped with a series governed 50/60 hz motor which can be used on either system with only minor changes. This is achieved by a "Governor" on the back end of the motor which can be regulated to compensate for different frequencies. The motor runs at a constant 3600 r.p.m., using a 60 hz gear set. When the motor is run on 50 hz, which would give a speed of 3000 r.p.m., the "Governor" is varied by means of a screw in the "Governor". By using a tuning fork tuned to a motor speed of 3600 r.p.m., bring the motor speed back up to 3600 r.p.m. Hence, the only change required when switching the punch between different systems is to adjust the "Governor" to give a speed of 3600 r.p.m. The method is explained in BRPE Technical Manual Bulletin 295B pages 10, 11 of the "Principles of Operation" section and pages 6 and 7 of the "Adjustments" section.

The Thermostatic switch used, however, must be the one for the system frequency that the punch is being run on.

TOOLS	DEC #	TTY#
Tuning Fork	29-16114	104986

digital	FIELD SERVICE TECHNICAL MANUAL				Option or Designator
	12 Bit <input checked="" type="checkbox"/>	16 Bit <input type="checkbox"/>	18 Bit <input type="checkbox"/>	36 Bit <input type="checkbox"/>	PP67

Title TUNGSTEN CARBIDE DIE BLOCK ASSEMBLIES				Tech Tip Number PP67-TT-3	
All	Processor Applicability	Author MacKenzie/Gleeson	Rev 0	Cross Reference	
8's		Approval W. Cummins	Date 7-31-72		

The Maynard stockroom will soon have available both 6 and 8 level tungsten carbide die block assemblies for the BRPE punch.

These die blocks and pins have a life of something in excess of 15 times that of the conventional die blocks. They will also allow the user to punch other types of tape such as mylar or aluminum with no problems. Of course, the more abrasive tapes will increase the wear factor, but these blocks are built for punching them.

These are highly precision devices and at no time should anyone attempt to disassemble the die block. The vendor is the only one capable of doing this. If any problems are encountered, simply return it to Maynard for repair.

The die blocks are etched with digitals name-block number and pin size. Thus you would see: Digital-6EE. The 6 means it was block number 6. The EE is the pin size. The vendor has agreed to make all blocks and pins the same size.

When installing these blocks do not use the punch pin retaining plate. This is not necessary for the operation of the punch.

It is recommended that all contract machines have the tungsten carbide die blocks installed when the conventional blocks wear out.

All old die blocks should be returned to Maynard for credit.

They will also be offered for sale to anyone interested in purchasing them.

The part numbers and selling prices are as follows:

Description	DEC No.	Prices
6 level adv. feed w/pins	29-17Ø14	\$ 430.00
8 level ctr. feed w/pins	29-17Ø15	450.00
Code pin	29-1742Ø	18.00
Feed Pin	29-17421	30.00

NOTE: THESE BLOCKS SHOULD ONLY BE INSTALLED WHEN THE OLD ONE WEARS OUT.

COMPANY CONFIDENTIAL

Title TROUBLESHOOTING THE PP67A/B MOTOR CONTROL CIRCUIT						Tech Tip	
						Number PP67-TT-4	
All		Processor Applicability		Author Rasmussen/Tinkham		Rev 0	
8's				Approval W. Cummins		Date 7-31-72	
						Cross Reference	

During normal typesetting operation, the rotary switch on the top of the punch is in the available position. If the punch fails to work correctly, this may be an indication of a faulty motor control circuit. This circuit is located inside the punch cover on top of the motor.

The PP67A/B motor control circuit is quite easy to troubleshoot with the following technical tip.

There are two main troubles that occur in the control circuitry. The first is the punch motor never turns on. This is usually a bad transistor. The second trouble is the punch motor once on, will never turn off. This is a bad SCR in most cases. This procedure can only be used in the case of the punch never turning on.

Using Figure 1, if the punch does not turn on properly, you can find the trouble using a jumper wire.

- 1) Turn off/on switch (on side of punch near the motor) to ON position. If motor runs okay, go on to Step 2, if not, check 110 volts in motor or ON/OFF switch.
- 2) Turn OFF/ON switch to OFF position. Turn the rotary switch on top of punch to the continuous position and leave it there for the remainder of this procedure. Turn computer on (to supply -15V). If punch runs okay in this position, trouble is in rotary switch, cable, or computer interface (PA60/61 or PA68A). If the motor did not start, go to step #3.
- 3) Using jumper wire, short across SCR (D6) (points A to B) cathode to anode. If motor turns on, go on to step 4, if not, check for bad bridge return (D1-D4 or D7).
- 4) Using jumper wire, short across relay contact, (points C to D). If motor turns on, go to step 5, if not, check for bad SCR (gate).
- 5) Using jumper wire connector from cathode of D5 (Points E to F), to GND, if punch motor turns on, go to step 6, if not, check for bad relay or no-15V supply.
- 6) Using jumper wire, short across transistor (Q1) emitter to collector, (points G to H). If punch motor turns on, replace bad transistor or check R_3R_4 voltage divider. If punch motor does not turn on, go to step #7.

COMPANY CONFIDENTIAL

digital	FIELD SERVICE TECHNICAL MANUAL				Option or Designator
	12 Bit <input checked="" type="checkbox"/>	16 Bit <input type="checkbox"/>	18 Bit <input type="checkbox"/>	36 Bit <input type="checkbox"/>	PP67

Title TROUBLESHOOTING THE PP67A/B MOTOR CONTROL CIRCUIT (Continued)				Tech Tip Number PP67-TT-4	
All Processor Applicability		Author Rasmussen/Tinkham Rev β		Cross Reference	
8's		Approval W. Cummins Date 7-31-72			

- 7) Using jumper wire, connect the emitter of the transistor to ground (points G to F). If the punch turns on, check for a broken wire from the emitter to the rotary switch, a broken ground connection to the rotary switch, or a faulty rotary switch. If the punch does not turn on, the problem is not within the punch motor control circuit.

One other problem found in the punch control circuit is resistors R_1 and R_2 (47 ohm) burnt. This was caused by the SCR having an open cathode. When the relay contact closed, 110 volts is dropped across R_1 and R_2 and if SCR fails to fire, R_1 and R_2 will burn up.

For replacement part numbers for any of the above mentioned items, refer to punch control circuit schematics D-CS-7005095-0-1, Revision A.

COMPANY CONFIDENTIAL

COMPANY CONFIDENTIAL

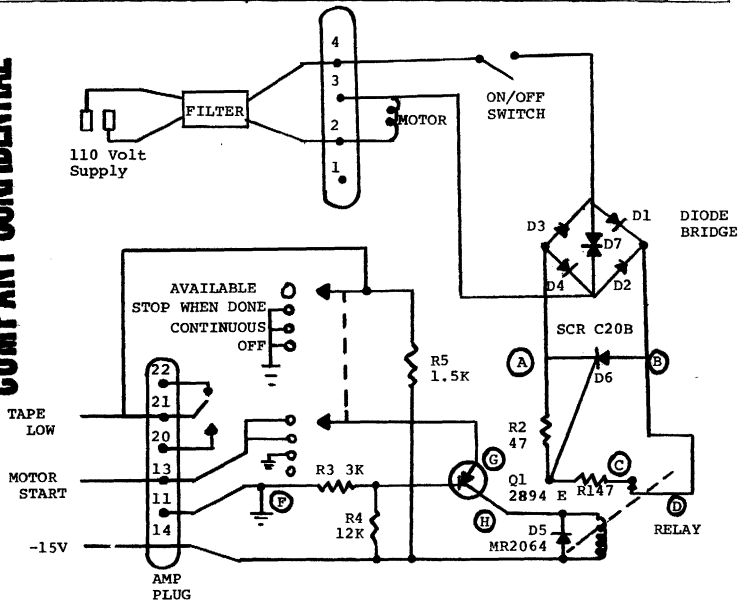
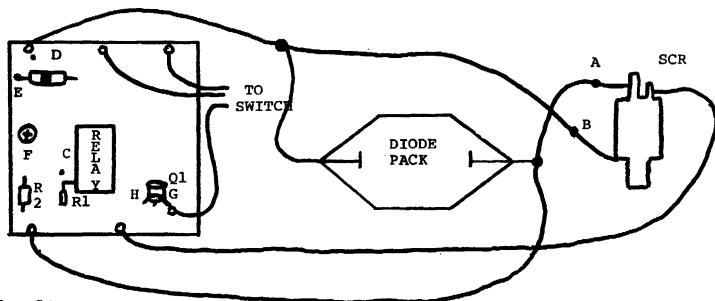

FIGURE 1



digital	FIELD SERVICE TECHNICAL MANUAL				Option or Designator
	12 Bit <input checked="" type="checkbox"/>	16 Bit <input checked="" type="checkbox"/>	18 Bit <input type="checkbox"/>	36 Bit <input type="checkbox"/>	PP67

Title PP67-PUNCH CABLE IMPROPERLY MANUFACTURED (BC01F)				Tech Tip Number PP67-TT-5	
All Processor Applicability			Author <u>Craig Showers</u>	Rev <u>A</u>	Cross Reference
8	11		Approval <u>G. Chaisson</u>	Date <u>11/20/73</u>	

It has been found that the BC01F cable which consists of a M979 module has a capacitor C12 which has the wrong voltage value installed. It is 20 volts at present and should be a 50 volt cap.

The print set reflects the correct part number and must have been an error at assembly. Please check at next service call, or next P.M. and replace if necessary.

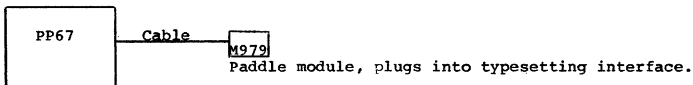

Title PP67 PUNCH MOTOR PART NUMBER				Tech Tip Number PP67-TT-6	
All Processor Applicability			Author <u>Rich Brown</u>	Rev <u>g</u>	Cross Reference
8	11	10	Approval <u>Fred Miller</u>	Date <u>9/26/74</u>	

The part number listed in the print sets for the PP67 motor is wrong (12-4851-LMU6). The part number should be 29-11240 (LMU3). The LMU6 motor is a series regulated motor of which there were a limited number shipped.

-- NOTES --

digital	FIELD SERVICE TECHNICAL MANUAL				Option or Designator
	12 Bit <input checked="" type="checkbox"/>	16 Bit <input type="checkbox"/>	18 Bit <input type="checkbox"/>	36 Bit <input type="checkbox"/>	PR68
Title G900 PROBLEMS				Tech Tip PR68A-TT-1 Number	
Processor Applicability		Author D. Debarge	Rev 0	Cross Reference	
All 8's		Approval W. E. Cummins	Date 7-31-72		

Revision C boards, and some revision B, have a basic defect in that the trim pot is wired into the circuit incorrectly. These problems were identified by Tom Gibson and Norm Howe and are detailed in the schematic below.

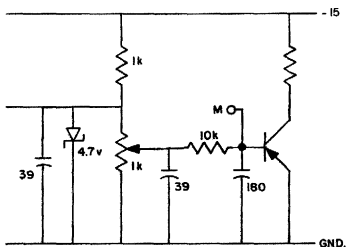

CORRECT CIRCUIT

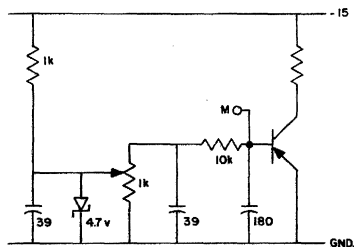

INCORRECT CIRCUIT IN G900 - REV B & C

Reworking of revision C boards involves the cutting of etch (Fig. 1) and the installation of jumpers (Fig. 2).

Revision B boards can be repaired by simply connecting the trim pot leads to the proper split lug (see Fig. 3 next page).

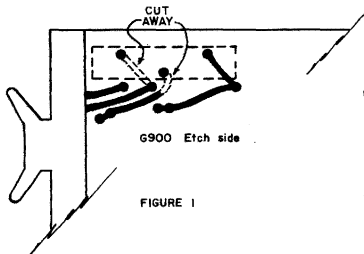

FIGURE 1

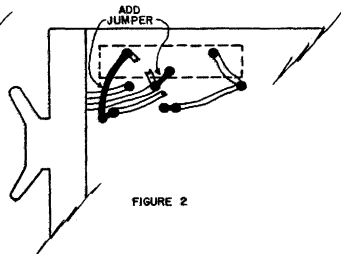

FIGURE 2

COMPANY CONFIDENTIAL

Title G900 PROBLEMS (CONTINUED)						Tech Tip Number PR68 -TT-1	
All Processor Applicability		Author D. Debarge		Rev 0		Cross Reference	
8'S		Approval W. E. Cummins		Date 7-31-72			

PHOTO CELL LEADS	I	H	F	E	D	C	G	B	A
G900 INSTALLED IN PR68 SLOT	DATA CHANNEL								
1	-	-	4	3	feed	2	1	-	-
2	7	6	-	-	-	-	5	ø	-
G900 INPUT PIN	U	S	P	M	K	H	E	A	
BIAS RESISTOR - OHMS -	15k	12k	10k	10k	5.6k	10k	12k	15k	

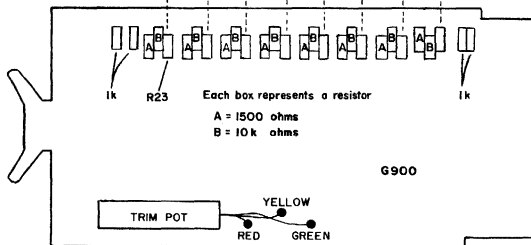

FIGURE 3

Revision F boards will be released shortly and will incorporate the final scheme of compensating bias resistors. The resistor scheme (which is shown above) should be implemented in the field on all older boards.

- Revision A - All bias resistors 10K ohms.
B - All bias resistors changed except R23 at input pin U. Some defective because of trim pot miswiring (see over).
C - All were defective - trim pot miswired - can be reworked as detailed on previous page)
D - Correction to revision C but made improperly - not released.
E - Revision D corrected - R23 still 10K.
F - All known problems corrected - R23 changed to 15K.

digital	FIELD SERVICE TECHNICAL MANUAL				Option or Designator
	12 Bit <input checked="" type="checkbox"/>	16 Bit <input type="checkbox"/>	18 Bit <input type="checkbox"/>	36 Bit <input type="checkbox"/>	PR68

Title SET-UP PROCEDURE FOR THE PR68A TYPESETTING READER				Tech Tip PR68 -TT-2	
				Number	
All	Processor Applicability			Author J. Gleeson	Rev A
8'S				Approval W. E. Cummin	Date 7-31-72
				Cross Reference	

Before commencing the set-up procedure check that the G900 modules in the reader are modified to revision F level. If they are not, the G900's must be brought up to date before attempting any adjustments.

STATIC ADJUSTMENTS

1. Diagram I - Measure the voltage across the reader lamp. This should be 10V. If it is not, slacken the clamp connector on the 7.5 ohm resistor in the reader and move the clamp until 10V is obtained. Tighten the clamp, then recheck voltage. If cables are over 150' the -15 volt and ground lines must have dual wires in the cable.

2. Diagram II Release the screw holding the 6 level guide and if the reader is to be used for 8 level, drop the guide to its lowest position and tighten the screw. If the reader is to be used for 6 level, move the guide up until the guide surface is flush with the surface of the cell block. Tighten the screw.

Take a short piece of tape, 6 or 8 level appropriate to the reader use, and place it in the reader. Adjust the cell block, with the two screws shown, so that the tape lies flat across the sprocket wheel and the cell block surface. Tighten the screws.

Place 3 thicknesses of tape between the tape bed and tape hold-down weight and tighten the screw that connects it to the back plate. The weight should now be secured.

3. Diagram III - Rotate the lamp so that the filament produces an even beam of light and casts no shadow, from the bulb's seam, over the apertures. (Note: inspect the bulb for filament sag, if present replace the bulb). Adjust the condensing lens so that the flat portion is parallel with the cell block. Loosen the two set screws on the bracket assembly and move it forward or backward to make the light beam cut across the right hand edge of the apertures.

COMPANY CONFIDENTIAL

Title SET-UP PROCEDURE (CONTINUED)						Tech Tip Number PR68 -TT-2	
All 8's	Processor Applicability			Author J. Gleeson	Rev 0	Cross Reference	
				Approval W.E.Cummins	Date 7-31-72		

4. Diagram IV - Take a short piece of tape with a rub-out code perforated about half way along the tape and place it in the reader. Release the two allen set screws in the sprocket wheel and, holding the tape taut across the cell block and wheel, move the sprocket wheel laterally so that the holes in the tape are centered over the photo cell apertures. Be sure that the tape is not curled up against the back plate. Partially tighten one of the screws.
5. Diagram V - Select the required reader via the PA60 control by loading the following program:

Ø / 7604 LAS
6312 RSC
7402 HLT

Load ADD Ø, set the reader number in SR bits 8-11, then press START.

Release the screw in the wheel and keeping the lateral position fixed, rotate the wheel axially until the leading edge of the tape holes is just touching the right hand edge of the light beam. Tighten the allen set screws in the wheel.

6. Diagram VI Put the spring arm down and check that the straight part of the fingers are horizontal and just touching the wheel. Careful use of long-nosed pliers may be used to achieve this. Also check from above that the fingers are centered over the sprockets on the wheel.

RUNNING ADJUSTMENTS

When all preliminary adjustments have been made, the reader should be margined. There are two methods of doing this:

- Using a short program (or Typeset Configuration Test Program 10) read a 1's and Ø's tape loop. Observe the AC for data and swing the pots on the G900's from the extreme of picking up bits to the extreme of losing bits, counting the number of full turns. Set the pots at 40% back from the point of picking up; i.e., if 10 turns obtained, set the pot 4 turns from picking up. It is likely that when checking bits 1, 2, 3, 4, the feed hole will be picked up first, causing the program to hang up on the flag. This is the extreme of that direction. A minimum of 6 turns should be obtained on both pots.
- Reading a 1's and Ø's loop, and using a scope, hang one probe on A29J; PA60A (hole Ø) or B15P (PA68A) and the other probe on A24J(PA60A), B12E (PA68A) and observe the relationship between the data and "strobe". Adjust the pot and if necessary the wheel to obtain timing as shown below.

digital	FIELD SERVICE TECHNICAL MANUAL				Option or Designator
	12 Bit <input checked="" type="checkbox"/>	16 Bit <input type="checkbox"/>	18 Bit <input type="checkbox"/>	36 Bit <input type="checkbox"/>	PR68

Title SET-UP PROCEDURE (CONTINUED)				Tech Tip PA68 -TT-2 Number	
All	Processor Applicability		Author J. Gleeson	Rev 0	Cross Reference
8'S			Approval W.E.Cummins	Date 7-31-72	

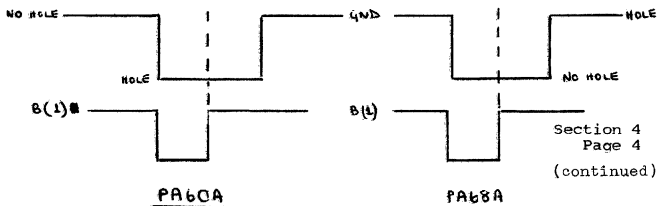

Repeat for the other pot using Data Hole 3 (A28J; PA60A or B14P; PA68A). A comparison between Data Hole \emptyset and Data Hole 5 (A28V; PA60A or B13V; PA68A) may be made to check for skew.

When the margins have been set up satisfactorily, using a short piece of tape check that the control sees "out of tape" as the tape runs out. Slight re-adjustment of the G900 may be necessary but do not move too far from the 40/60 setting if method 1 used. Recheck the adjustments if this cannot be obtained. Also check that the tape switch is wired to simulate the "out of tape" condition, by lifting the arm up.

MIXED TAPE LEVEL SYSTEMS

Some systems have the requirement to be able to read both 6 and 8 level tape. Where both tapes are advanced feed hole, the procedure is the same as described above except that the check for skew should be made between hole \emptyset and hole 7 (A27P; PA60A or B13J; PA68A).

Where the 8 level tape is center feed hole, it has been found to be better, where possible, to reserve a reader for reading 8 level tape only. If this is not practical, the readers should be set up as for 6 level tape and then marginal re-adjustment of the sprocket wheel made, together with re-margining of the pots, to accommodate both tapes.

When all readers have been set up satisfactorily, do a final check, using either the Typesetting Configuration Maindec 08-D2HB or the TCSE.

COMPANY CONFIDENTIAL

Title SET-UP PROCEDURE (CONTINUED)				Tech Tip PR68 -TT-2 Number	
Processor Applicability		Author J. Gleeson	Rev 0	Cross Reference	
All		Approval W.E.Cummins	Date 7-31-72		
8's					

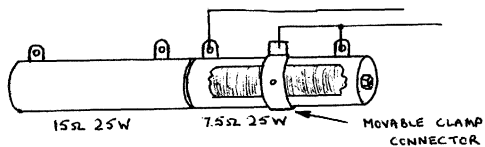

DIAGRAM 1

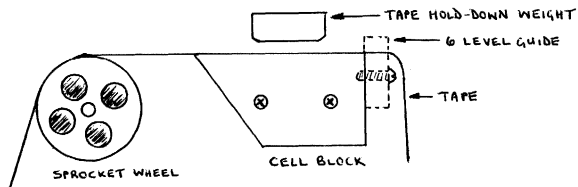

DIAGRAM 2

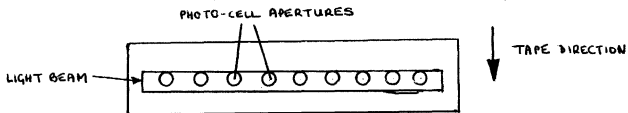

DIAGRAM 3

COMPANY CONFIDENTIAL

digital	FIELD SERVICE TECHNICAL MANUAL				Option or Designator
	12 Bit <input checked="" type="checkbox"/>	16 Bit <input type="checkbox"/>	18 Bit <input type="checkbox"/>	36 Bit <input type="checkbox"/>	PR68

Title SET-UP PROCEDURE (CONTINUED)				Tech Tip PR68 -TT-2 Number	
All	Processor Applicability		Author J. Gleeson	Rev 0	Cross Reference
8'S			Approval W.E.Cummins	Date 7-31-72	

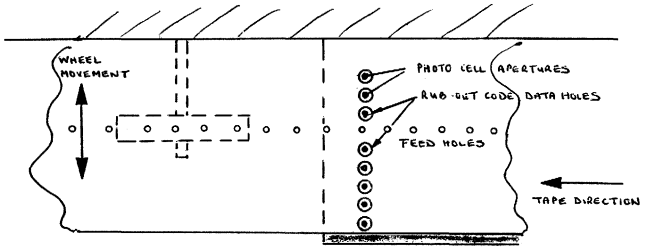

DIAGRAM 4

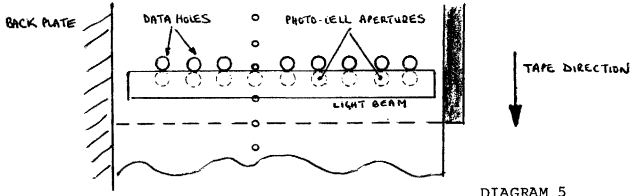

DIAGRAM 5

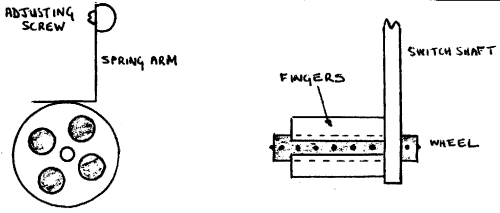

DIAGRAM 6

COMPANY CONFIDENTIAL

Title						Tech Tip Number		PR68-TT-3							
READER INTERRUPT WITH CSI						Author		P. Bezeredi		Rev		0		Cross Reference	
All 8's		Processor Applicability				Approval		W. E. Cummin		Date		7-31-72			

On CSI Systems, the reader interrupt has been disabled in order for the CSI Program to run. On most systems CSI does this by taping a pin on the module which generates INTER REQ for the reader, but on some systems this is hard wired in. This tape or wire must be removed in order that the System Exerciser and all DEC MAINdecs can be run.

COMPANY CONFIDENTIAL

digital	FIELD SERVICE TECHNICAL MANUAL				Option or Designator
	12 Bit <input checked="" type="checkbox"/>	16 Bit <input type="checkbox"/>	18 Bit <input type="checkbox"/>	36 Bit <input type="checkbox"/>	PR68

Title PR68A, PR68B COVER BOX PROBLEM				Tech Tip PR68-TT-4 Number	
All s i s	Processor Applicability		Author P.Tinkham	Rev 0	Cross Reference
			Approval W.E.Cummins	Date 7-31-72	

PROBLEM: Improper mounting of the top cover box on PR68A and PR68B readers. Insufficient clearance between the cover box and the mounting plate for the Osram Bulb may cause a short circuit from -15 volts to ground. The threaded standoffs used to mount the cover box are not of correct lengths. Specified length of these standoffs is 1 3/8 inches. However, it has been discovered their actual length varies from 1 5/16 inches to 1 3/8 inches.

SOLUTION: Increase the length of the threaded standoffs to achieve a reasonable amount of clearance between the cover box and the Osram Bulb mounting plate. There are two suitable methods of resolving the problem.

- 1) Add washers as necessary behind the standoffs to effectively increase their length.
- 2) Replace the existing standoffs with same of correct length (1 3/8 inches).

PARTS LIST

Item No.	Drawing No.	Part No.	Description
27	MA-E-PR68A-0-1	None	Plain Washer (Medium) 5/16 O.D X 5/32 I.D.
28	MA-E-PR68A-0-1	None	External Tooth Lock Washer, #6 Hole Set
29	MA-E-PR68A-0-1	None	Threaded Standoff #6 32 X 1 3/8 Lg

NOTE: Either Washer (item 27 or 28) may be used.

COMPANY CONFIDENTIAL

Title ^o SET UP PROCEDURE FOR THE PR68B READER					Tech Tip Number PR68-TT-5	
All 8's	Processor Applicability				Author John Gleeson	Rev 0
					Approval W. Cummins	Date 7-31-72
Cross Reference						

All adjustments for the PR68B reader are the same as for the PR68A with the exception of the following:

- Using a piece of tape with a rub-out perforated in it, adjust the sprocket wheel axially so that the Data Holes on tape are positioned directly over the photo cell apertures, then move marginally either side to obtain best margins by either method described in the PA68A Tech Tip. The reason for the difference in Data Hole positioning as compared to the PR68A is that in positive logic interfaces the strobe occurs earlier.
- In the PR68B there is only one amplifier module, a G908.
- Using the scope method for margining, the points to look at are:

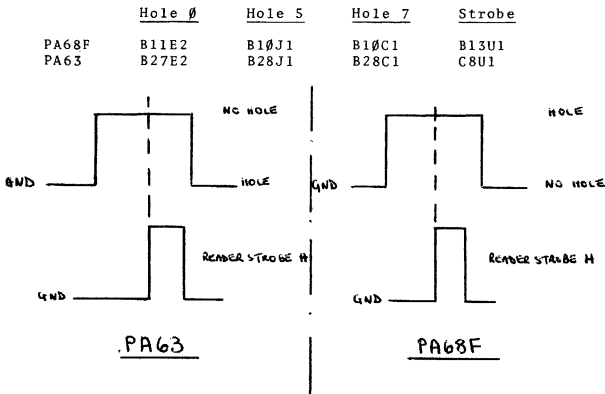

COMPANY CONFIDENTIAL

digital	FIELD SERVICE TECHNICAL MANUAL				Option or Designator
	12 Bit <input checked="" type="checkbox"/>	16 Bit <input type="checkbox"/>	18 Bit <input type="checkbox"/>	36 Bit <input type="checkbox"/>	PR68

Title G930 - USED IN PR68D READER				Tech Tip Number PR68-TT-6		
All g's	Processor Applicability			Author J. Gleeson	Rev 0	Cross Reference
				Approval W. Cummins	Date 7-31-72	

The PA63 provides a user with a "NON-TORN-TAPE-ALLOTTING" system (NTTA) by the simple addition of one G930 module to each reader in the system. The customer's use of this option is the same as described in the PA60C Tech Tip so this description will be confined to the logic theory.

Theory of Operation - See Diagram 1

Initial Conditions:

- a) Point "A" is HIGH.
- b) Point "C" is HIGH, therefore, "D" is LOW, turning on transistor Q2 and lighting the lamp.
- c) Point "D" being LOW, point "F" is HIGH, turning on transistor Q1 and hence holding point "G" at GND.
- d) The flip flop is in the "0" state, hence point "B" is LOW.
- e) Point "G" being "LOW", the clock input to the flip flop is HIGH.

Operation:

- 1) When the switch on the reader is pressed, a LOW is applied to points "A" and "C".
- 2) The point "D" goes HIGH, cutting off transistor Q2, thus extinguishing the lamp.
- 3) Point "F" goes low, cutting off transistor Q1 and allowing point "G" (Bus) to follow the level of SEL RDR XX H; the bus being tied to this level in the PA63 interface. Assuming this reader not program selected at this stage, point "G" remains LOW.
- 4) Point "A" provides a LOW through chips E1 and E2 at point "C" which is fed back to point A thus "remembering" the operation of the switch.
- 5) When this reader is program selected, point "G" goes "High" but has no effect on the flip flop since the clock input "H" is negative going. The tape in this reader is then processed.
- 6) When tape processing has been completed, the program deselects the reader, thus point "G" goes LOW. This provides a positive going clock pulse to the flip flop setting it to the "1" state.
- 7) Point "B" goes HIGH, point "C" therefore goes HIGH and point "D" goes LOW. Q2 is turned on, lighting the lamp and Q1 is turn on tying point "G" to ground.

Title G930 - USED IN PR68D READER (Continued)				Tech Tip Number PR68-TT-6	
All Processor Applicability		Author J. Gleeson		Rev 0	
8's		Approval W. Cummins		Date 7-31-72	
Cross Reference					

- 8) Point "D" going LOW resets the flip flop at point "J" and point "C" being HIGH provides a feedback to point "A" to re-establish initial conditions.

Inhibit Facility:

When installed, this option can be disabled at any time by throwing a switch, mounted in the PA63, to the "OFF" position.

PR68DA Reader:

When this option is not installed, the readers have the designation PR68DA. The following modifications are made to the reader. (See print PR68-D-2):

- 1) Momentary switch replaced with ON/OFF switch.
- 2) 56 OHM resistor added from B04F2 to A04V1.

Also the jumper providing +5V to the NTTA switch in the PA63 is disconnected from the +5V line and taped down in the power supply.

If this option is field fitted, the switch must be changed: The resistor removed; a G930 inserted in slot B04 in each reader in the system. Also the NTTA switch in the PA63 must be rewired to +5V.

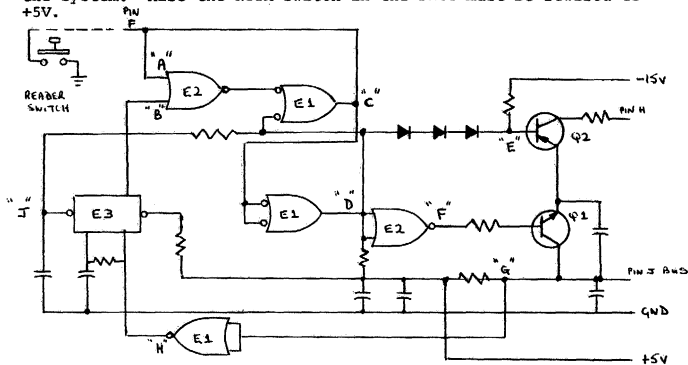

Pin F = input from reader switch

Pin H = output to indicator lamp

Pin J, Bus = tied to SEL RDR XX H in PA63

COMPANY CONFIDENTIAL

digital	FIELD SERVICE TECHNICAL MANUAL				Option or Designator
	12 Bit <input checked="" type="checkbox"/>	16 Bit <input type="checkbox"/>	18 Bit <input type="checkbox"/>	36 Bit <input type="checkbox"/>	PR68

Title				Tech Tip		
BC01H READER CABLE MISWIRED				Number PR68-TT-7		
All 8's	Processor Applicability		Author	J. Gleeson	Rev 0	Cross Reference
			Approval	W. Cummins	Date 7-31-72	

There is a possibility that some BC01H cables used with PR68D/DA Readers may have reached the Field incorrectly wired. There is an 0.1 MFD 100 volt capacitor on the M908 connector at the control end of the cable. This capacitor is supposed to be wired from SEL RDR XXH (Pin V1) to ground (Pin T1). However, some cables have been found with this capacitor errantly wired from SEL RED XXH. (Pin V1) to +30 volts (Pin S1 or U1). On systems with PR68D Readers (NTTA) the problem may show up as an inability to select a reader even after repeated attempts at pressing the reader select switch. On systems with PR68D readers (Non NTTA) the problem may show up as intermittent reader selection errors caused by the noise induced from +30 volt line. The cure is to simply rewire the capacitor correctly from Pin V1 to pin T1. It is recommended that all BC01H reader cables be checked and corrected, if necessary.

Title				Tech Tip		
CLARIFICATION AND CORRECTION OF TYPESETTING ECO's				Number PR68-TT-8		
All 8's	Processor Applicability		Author	F. Miller	Rev 0	Cross Reference
			Approval	W. Cummins	Date 7-31-72	

PA63-00012:

- 1) Do not delete B28D1 to B28F2.
- 2) If not already present, add the following to 6/8 level switch.
 - a) Add #22 AWG S1 -C (red/wht) to B28D1
 - b) Add #22 AWG S1 -N/O (brn/wht) to C08C2
 - c) Add #22 AWG S1 -N/C (blu/wht) to B21V1

PR68D-00015A: (PR68D-00015A takes precedence over PR68D-00015)
Item 16 and 21, sheet 3 of 6 are for PR68D only
(Non-NTTA)

- 1) Add #22 AWG (gry/blk) wire between rocker switch, N/C position and A2 on W023A connector card in slot B01.
- 2) Remove wire jumper on A2 W023A connector card and add 1K 1/4W resistor.

Again, this is only for PR68DA Readers.

COMPANY CONFIDENTIAL

Title Clarification and Correction of Typesetting ECO's (continued)						Tech Tip Number	PR68-TT-8			
All 8's	Processor Applicability					Author	F. Miller	Rev	0	Cross Reference
						Approval	W. Cummins	Date	7-31-72	

Possible M710 Problems:

When punch is activated and the 5 second delay times out, the first character is punched. The 5 second delay may be cleared again, punching a character every 5 seconds. This is caused by etch layout on M710 Rev. F.

Field Solution:

Add .01 mfd/.00V cap to A07 V2 to gnd on PA68F and A30 V2 to gnd on PA63.

ECO's are being prepared to cover the deficient areas.

Title INFORMATION: LENS FOR PC04/PR68D/DA READERS						Tech Tip Number	PR68-TT- 9			
All 8's	Processor Applicability					Author	P. Bezeredi	Rev	Ø	Cross Reference
						Approval	W. Cummins	Date	7-31-72	

Problem:

The lens for the PC04 Reader (1 1/16 inches long) was assigned that same part number (74-4989) as the lens for the PR68 Typesetting Reader (1 3/16 inches long).

Text:

Each lens now has its own part number. Use the following numbers when ordering:

<u>Part #</u>	<u>Description</u>	<u>Used On</u>
74-4989-Ø	Lens, 1 1/16in. long	PC04
74-4989-1	Lens, 1 3/16in. long	PR68 (A,B,C,D,DA)

NOTE: This Tech Tip replaces Tech Tip labeled "Short Lens on PR68A/PR68B" Section 4, Page 14, which is obsolete.

COMPANY CONFIDENTIAL

CPL

digital	FIELD SERVICE TECHNICAL MANUAL				Option or Designator
	12 Bit <input checked="" type="checkbox"/>	16 Bit <input type="checkbox"/>	18 Bit <input type="checkbox"/>	36 Bit <input type="checkbox"/>	PR68

Title PR68A MODIFICATION				Tech Tip Number PR68-TT-10	
All Processor Applicability				Author R. Boehm	Rev C
8				Approval F. Miller	Date 12/6/73
				Cross Reference	

Phenolic Block (Photocell Assy) P/N 29-15961 can no longer be ordered. If a new photo cell assembly is needed order ECO Kit PR68A-11 or PR68B-7. The new photocell assembly requires modification of the PR68A interface cable by replacing the reader end with a modified M978B or M9780 module. This module is supplied with the kit which also includes the new photo-cell assembly P/N 70-09382, cable clamps and hardware, and necessary procedures and specifications.

If a modified PR68A or B is in need of repair you only need to order the part that is bad, not another ECO kit. All part numbers are included with specifications in the kit. The PR68B kit consists of only the photocell assembly P/N70-09382-1 and ECO.

Before installing a new photocell assy. it is advisable to solder the termipoint connections as it has been found that the connections on some assemblies are very poor and will cause reader problems.

CPL

Title PR68-READER CABLE IMPROPERLY MANUFACTURED (BC01H)				Tech Tip Number PR68-TT#11	
All Processor Applicability				Author C. Showers	Rev A
8	11			Approval G. Chaisson	Date 12/6/73
				Cross Reference	

It has been found that the BC01H cable which consists of a M978 module has a capacitor C12 which has the wrong voltaga value installed. It is 20 volts at present and should be 50 volt cap. The print set reflects the correct part number and must have been an error at assembly. Please check at next service call, or next P.M. and replace if necessary.

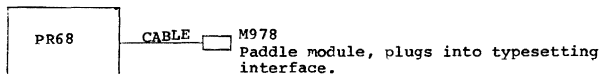

-- NOTES --

digital	FIELD SERVICE TECHNICAL MANUAL				Option or Designator
	12 Bit <input checked="" type="checkbox"/>	16 Bit <input type="checkbox"/>	18 Bit <input type="checkbox"/>	36 Bit <input type="checkbox"/>	PT08

Title				PT08 - OPTION SELECTION JUMPERS		Tech Tip Number	PT08-TT-1
All	Processor Applicability			Author	Robert Shelley	Rev	0
	8	8S	8I	8L	Approval	W. Cummins	Date 7-31-72
							Cross Reference

Diagrams on the three pages that follow describe options and set up of the W706 modules used in PT08's.

Special Notes:

1. For best results the W706 should be jumpered for a 1/2 stop bit less than the transmitting device is transmitting. This allows a half bit time to get back in sync if there is a slight timing mis-match between the PT08's clock and the device sending to the W706.
2. The 'NO RUN OPEN' option may be used in special applications where it is not desirable to get continual flag interrupts if the W706's input is open. (TTY unplugged, VT06 with power off, etc.) The option prevents the receiver from starting to receive a second character until the stop bit (mark) has been received from the first character. The 'NO RUN OPEN' option requires at least 1.5 stop bits to function properly.
3. Another special application feature is available on W706's that have etch revision D. Clearing the receive flag may be accomplished by either 10P2 or 10P4. The factory standard is 10P2.
4. In all cases the W707 must be jumpered for the full number of stop bits required by the receiving device.

COMPANY CONFIDENTIAL

digital	FIELD SERVICE TECHNICAL MANUAL				Option or Designator
	12 Bit <input checked="" type="checkbox"/>	16 Bit <input type="checkbox"/>	18 Bit <input type="checkbox"/>	36 Bit <input type="checkbox"/>	PT08

Title PT08 - OPTION SELECTION JUMPERS				Tech Tip Number PT08-TT-1	
All Processor Applicability		Author Bob Shelley		Rev 0	
8	8S	8I	8L	Approval Bill Cummins Date 7-31-72	
				Cross Reference	

W706 ETCH REV. C

CS REV. A

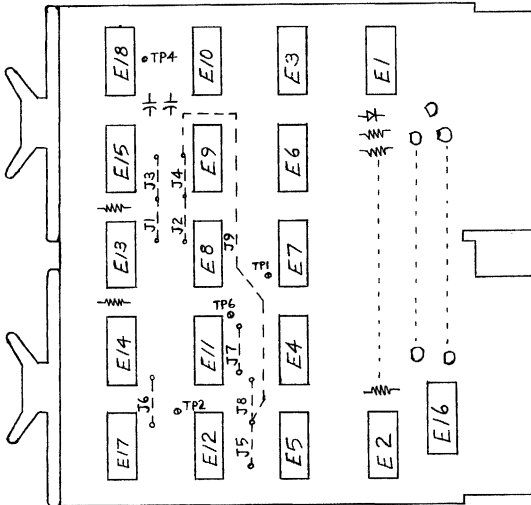

5 BIT CODE: INSERT J3, J4; REMOVE J1, J2

8 BIT CODE: INSERT J1, J2; REMOVE J3, J4

NO RUN OPEN: INSERT J6, J9; REMOVE J5, J7, J8

0.5 STOP BITS: Set up jumpers for 1.0 stop bits and insert a jumper between pins 9 and 10 of E5.

1.0 STOP BITS: INSERT J5 and J6; REMOVE J7, J8, J9

1.5 STOP BITS: INSERT J7 and J8; REMOVE J5, J6, J9

2.0 STOP BITS: INSERT J6 and J8; REMOVE J5, J7, J9

Use insulated wire for J9

COMPANY CONFIDENTIAL

Title PT08 - OPTION SELECTION JUMPERS					Tech Tip Number PT08-TT-1		
All	Processor Applicability				Author R. Shelley	Rev 0	Cross Reference
	8	8S	8T	8L	Approval W. Cummins	Date 7-31-72	

W706 ETCH REV. D CS REV. B

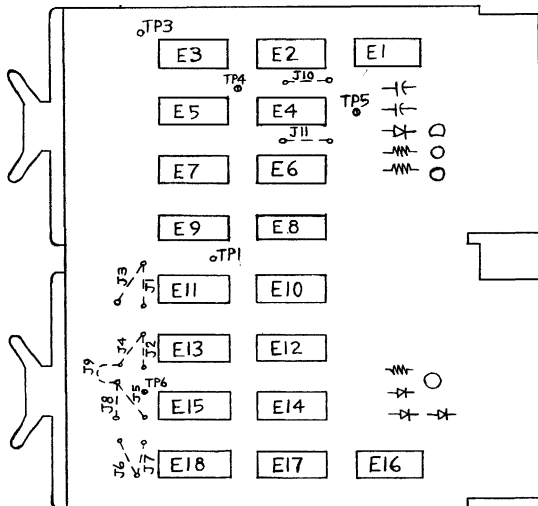

5 BIT CODE: INSERT J3, J4; REMOVE J1, J2

8 BIT CODE: INSERT J1, J2; REMOVE J3, J4

NO RUN OPEN: INSERT J6, J9; REMOVE J5, J7, J8

0.5 STOP BITS: SET UP JUMPERS for 1.0 STOP BITS and
INSERT a jumper between pins 1 & 2 of E14

1.0 STOP BITS: INSERT J5, J6; REMOVE J7, J8, J9

1.5 STOP BITS: INSERT J7, J8; REMOVE J5, J6, J9

2.0 STOP BITS: INSERT J6, J8; REMOVE J5, J7, J9

Clear Flag - Factory Standard:

Insert J10; Remove J11

Clear Flag - Special Applications:

Insert J11; Remove J10

digital	FIELD SERVICE TECHNICAL MANUAL				Option or Designator PT08
	12 Bit <input checked="" type="checkbox"/>	16 Bit <input type="checkbox"/>	18 Bit <input type="checkbox"/>	36 Bit <input type="checkbox"/>	

Title PT08 MODIFICATION				Tech Tip Number PT08-TT-2		
All	Processor Applicability			Author W. Cummins	Rev A	Cross Reference
				Approval W. Cummins	Date 7-31-72	

Past policy has kept the field from modifying a PT08 to a PT08F or PT08FX.

Now, however, it has been found relatively easy to modify a PT08 to a PT08F. The following procedures are included to enable the change. The printed dircuit revision must be C to implement this change.

Add the following to convert a	PT08B to a PT08BF location	PT08C to a PT08CF location
Jumper	A4D to B2D	A4D to B2D
Jumper	B1D to B2E	B1D to B2E
Jumper		A20D to B18D
Jumper		B17D to B18E
modem cable P/N 70-5717	B3	B3 & B19
W511	B1	B1 & B17
W602	A4	A4 & A20

These changes apply to only those PT08's with a receive clock in A16 or A32 and a transmit clock in B04 or B20.

To change a PT08 to a PT08X the following must be done (the printed circuit 500 3980 must be exposed to allow etch cuts and it must be Rev. C).

Changes	PT08B	PT08C *
Remove R401	A16 B4	A32 B20
Add R405	B16	B32
Add W708	B12	B28
Cut etch	B15V	B31V
Jumper	B16D to B12E	B32D to B28F
Jumper	B12S to B15S	B28S to B31S
Jumper	B12D to B5D	B28D to B21D
Jumper	B12J to A15J	B28J to A31J
Jumper	B12V to B15V	B28V to B31V
Jumper	B12L to A15F	B28L to A31F
Jumper	B12F to B15J	B28F to B31J
Jumper	B12P to B5U	B28P to B21U

*NOTE: Left half same as PT08B.

COMPANY CONFIDENTIAL

Title PT08 MODIFICATIONS (Continued)						Tech Tip Number PT08-TT-2		
All	Processor Applicability					Author W. Cummins	Rev A	Cross Reference
						Approval W. Cummins	Date 7-31-72	

Do the following when a W709 is to be supplied with the PT08X:

Add W709	PT08B B4	PT08C B20
Cut Etch	B04D to B05D	B20D to B21D
Delete	B16D to B12E	B32D to B28E
Add	B16D to B04V	B32D to B20V
Add	B04D to B12E	B20D to B28E
Add	B04J to 03J	B20J to A19J

Title DATA PHONE INSTALLATIONS WITH PT08						Tech Tip Number PT08-TT-3		
All 8's 12	Processor Applicability					Author R. Howington	Rev 0	Cross Reference
						Approval W. Cummins	Date 7-31-72	

It is essential that these factors be determined:

The module of the Data-Phone set with which the customer will be operating at the other end of the data-line must be determined so that compatibility of both stations can be assured. The telephone company can verify compatibility between various models.

The BAUD rate must be known. The customer's BAUD rate must be set the same as the BAUD rate at the other end of the data-line. The customer will usually have this information available for you or can obtain it.

The character code must be known. In effect this means that for intelligible data to be sent and received by the customer, he must know what type of character code the system at the other end of the data-line transmits and receives. The customer should normally have this information for you.

The IOT Device Code of the PT08 for the Data-Phone must be known. This code is normally one of the following: 11 & 12, 40 & 41, 42 & 43, 44 & 45, 46 & 47. It should be noted that the first device code is usually for the receiver portion of the PT08 and the second device code is usually for the transmitter portion of the PT08. This is not to be taken as the final word on this arrangement, but merely as an example. This should be checked out thoroughly before trying to check out the PT08.

The PT08 clocks must be set so that the Data-Phone will be operated at the correct BAUD rate. If the PT08 contains R401 clocks, the way to determine the setting for the clocks is as follows:

digital	FIELD SERVICE TECHNICAL MANUAL				Option or Designator PT08
	12 Bit <input checked="" type="checkbox"/>	16 Bit <input type="checkbox"/>	18 Bit <input type="checkbox"/>	36 Bit <input type="checkbox"/>	

Title DATA PHONE INSTALLATIONS WITH PT08				Tech Tip Number PT08-TT-3	
All Processor Applicability			Author R. Howington	Rev 0	Cross Reference
8's 12			Approval W. Cummins	Date	

$$\text{Time} = \frac{1}{\text{BAUD} \times 2}$$

Example: For a rate of 300 BAUD, the output of the clocks should be set for a ulse every 1.66ms.

$$\begin{aligned} \text{Time} &= \frac{1}{300 \times 2} \\ &= 1.66 \text{ msec} \end{aligned}$$

If the PT08 has a crystal clock, there is no adjustment for it. The logic for the PT08 is somewhat different for a crystal clock control; therefore, if it is desired to know the pulse rate of the clock, the following formulas may prove helpful:

Freq. = BAUD X 128 (if a W709 is used)
 Freq. = BAUD X 8 (if no W709 is used)

W709 is used when frequency is less than 4K BAUD.

After determining the settings for the clocks, they both must be set to the same rate (if they are R401's.)

Once the clocks have been set up the Data-Phone test can be run. The program write-up calls for a jumper from B03E to B03P; however, this does not allow the connecting cables to be tested. For best test results and most complete checkout, pin 2 and 3 of the 25 pin Cannon Plug should be jumpered together and the program run. (Do not connect the jumper from B03E to B03P).

The cable is wired as follows:

Color	25 Pin Cannon	W023	Signal
Black	Pin 1	C	Ground
Red	Pin 2	E	Transmit Data
Green	Pin 3	P	Received Data
White	Pin 20	K	Data Term. Ready (+10V)
Brown	Pin 7	C	Ground

The indications that the program is working correctly are that the program will cycle and the AC will be stepping. This program simply transmits data and reads back the same data and compares it to see if it is correct.

Normally this is as much as DEC is required to test, but it may be advantageous to go one step further and try transmitting and receiving data to and from the station at the other end of the data line.

Title DATA PHONE INSTALLATIONS WITH PT08						Tech Tip Number PT08-TT-3	
All Processor Applicability			Author R. Howington		Rev 0		Cross Reference
8's 12			Approval W. Cummins		Date 7-31-72		

The following is a program which will allow the use of the console teletype to send and receive data over the Data-Phone line to a remote teletype.

Loc: 200 / 6031	210 / 5207	
201 / 5211	211 / 6XX1	XX = IOT Code for Receiver, in PT08.
202 / 6036	212 / 5200	
203 / 6046	213 / 6XX6	
204 / 6YY6	214 / 5203	YY = IOT Code for Transmitter, in PT08.
205 / 6041		
206 / 5205		
207 / 6YY1		

This program will loop, waiting for data from the remote teletype or the console teletype. Anything typed on either will be printed on both.

If this test runs correctly, the installation and check out of the system should now be complete.

COMPANY CONFIDENTIAL

CFL

digital	FIELD SERVICE TECHNICAL MANUAL				Option or Designator
	12 Bit <input checked="" type="checkbox"/>	16 Bit <input type="checkbox"/>	18 Bit <input type="checkbox"/>	36 Bit <input type="checkbox"/>	Power Controls

Title POWER CONTROL CONNECTIONS				Tech Tip Number		TT#1	
All Processor Applicability		Author J. Blundell		Rev g		Cross Reference	
8e 8M 8f 11/05 11/20		Approval F. Purcell		Date 11/6/73			

Digitals current family of power controls, as typified by the 860 are controlled by a 3 wire low current D.C. Bus. The connectors are wired as shown below:



Mating face view of female connector

The rules are simple: 1) Pin 3 is ground (low)
 2) If Pin 1 is pulled low, the control will turn ON providing Pin 2 is floating.
 3) Pin 2 will turn the control OFF when it is pulled low. Pin 2 overrides Pin 3, and the "local" switch.

The mating housing is a DEC 12-09351 with three 12-09378 pins.

There will be more than one socket on a power control, and they will be wired in parallel, to carry on the remote turn on bus. No termination is required.

Note that this scheme is not directly compatible with older processors such as the PDP8E or PDP 11/20, which worked in this way:

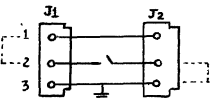

Rule: Pull Pin 1 to ground to turn processor on. (Processor switch across Pins 2). Jumpers are required from J1-1 to J1-2 and J2-2 to J2-3 to make the processor function.

It follows therefore that to make an 8E work an 860, the wiring should be as follows:

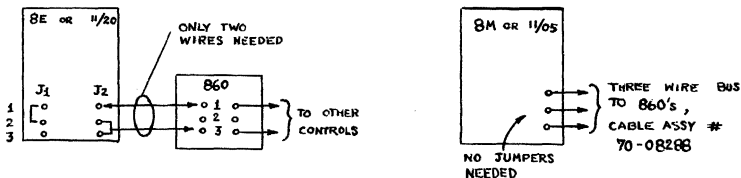

Title						Tech Tip	
NOTES ON 861 FAMILY POWER CONTROLS						Number PWR CONT--TT-2	
Processor Applicability			Author	Rev	Cross Reference		
All			Jeff Blundell	7			
X			Approval	Date	10/4/74		

A number of very intermittent system problems have been traced to the 861 family of power controls. A check of the following points may save some time chasing ghosts around the memory or I/O areas.

- 1) Check the small reed relay (powered by a simple DC power supply and controlled by the three wire power control bus) that controls the big AC power relay. If the 50 mfd. capacitor (the only capacitor on the pilot control board) goes low in capacity then the reed relay will begin to chatter and may even cause the power relay to intermittently drop out.

A quick test for this capacitor is to unplug all the remote control bus cables (they are the 3 pin mate-n-locks) and measure with a scope between pin 3 (the bottom pin - connect the scope ground to it) and pin 2 (the middle pin - connect the probe to it). Measure both the DC level and the ripple and compare with the values below.

Power control switch "REMOTE" or "OFF"	DC more than +27.5 volts ripple less than 100 mV p.p.
Power control switch "LOCAL ON"	DC more than +22.5 volts ripple less than 1 volt p.p.

These voltages may be slightly lower if the AC line is low, but should maintain the same relationship and ripple values.

- 2) For the following checks the power control must be removed from the system and totally disconnected from power.
 - a) Check on 861-A's incoming line filter connections against the Unit Assembly drawing. Note that the G (ground) terminal is further from the rear of the unit. Some filters fail to conform to our purchase specification both electrically (GG line not connected to case) and with regard to the orientation of the connections. If you suspect you are suffering from power line noise getting into the system, then replace any filter that does not agree with the UA drawing.
 - b) Ground for the sockets at the front is obtained through a single mounting screw that holds the duplex socket assembly to the chassis. The running of an additional ground wire between the receptacle ground screw terminal and the chassis ground stud (located near output side of line filter) may provide a better ground path and help to eliminate some types of noise sensitivity problems.

digital	FIELD SERVICE TECHNICAL MANUAL				Option or Designator POWER SUPPLIES (Deltron)
	12 Bit <input checked="" type="checkbox"/>	16 Bit <input checked="" type="checkbox"/>	18 Bit <input type="checkbox"/>	36 Bit <input type="checkbox"/>	
Title	CIRCUIT SCHEMATICS FOR THE DELTRON POWER SUPPLIES USED BY DEC.			Tech Tip Number	Pwr. Sup. TT-1
All <input checked="" type="checkbox"/>	Processor Applicability		Author	George Chaisson	Rev 0
			Approval	W. Cummins	Date 7-31-72
					Cross Reference

In many instances reference information is not available for reference power supplies used by DEC. This Tech Tip contains the circuit schematics for the Deltron power supplies used by DEC.

The power supplies with P/N 12-03185 can be found in the following options or subassemblies.

AA15-B	PDP-12	H7Ø8-B	7Ø-Ø8477-Ø2
AA15	H7Ø3	H7Ø9	79Ø-A
ACØ1-B	H7Ø7	H7Ø9-B	
ADØ8-A	H713	H738-A	
ADØ8-B	H739-A	7Ø-Ø8477-Ø1	
BD15	ADØ1-AN	7Ø-Ø6564-Ø1	
AIP12-A	ADØ1-AP	7Ø-Ø6564-Ø2	
AIP12-B	ADØ2-AN	7Ø-Ø837Ø-Ø1	
AIP12	ADØ2-AP	7Ø-Ø837Ø-Ø2	

The power supplies with P/N 12-03186 can be found in the following options.

AFC8-N	H7Ø2-A
AFC8-P	H7Ø2
H7Ø4-A	H727-A
H7Ø4-C	H727-B
H7Ø4	H7Ø4-H
AFC11	
AFCØ1-A	
AFCØ1-B	

/mt

COMPANY CONFIDENTIAL

Title		CIRCUIT SCHEMATICS FOR THE DELTRON POWER SUPPLIES USED BY DEC. (Continued)		Tech Tip Number		Pwr. Sup. TT-1	
All		Processor Applicability		Author George Chaisson Rev 0		Cross Reference	
X				Approval Bill Cummins Date 7-31-72			

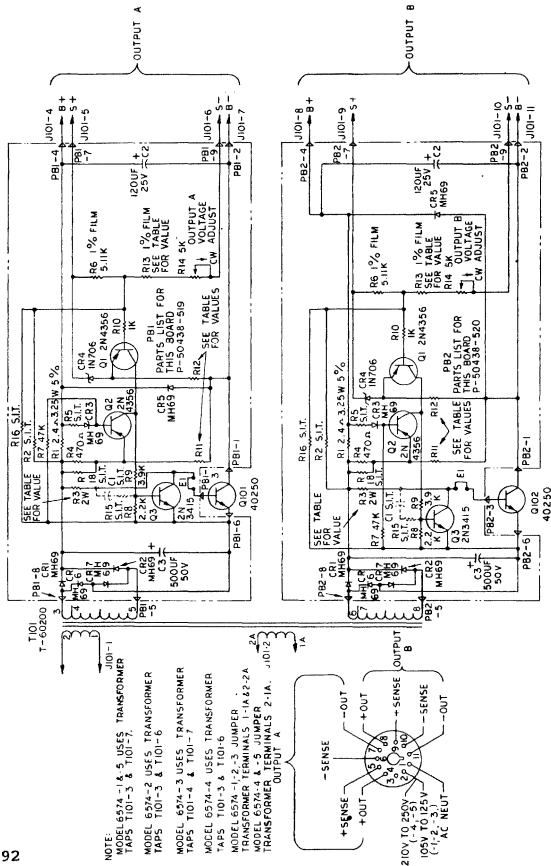

- NOTES:
1. RESISTOR WATTAGE 5 WATT UNLESS OTHERWISE INDICATED.
 2. ALL POTENTIOMETERS ARE WIREWOUND.
 3. ALL POTENTIOMETERS ARE 500Ω.
 4. RESISTORS TOLERANCE COMB ±10%; WIREWOUND ±10%; UNLESS OTHERWISE INDICATED.
 5. IF REMOTE SENSING IS NOT USED, CONNECT 4 TO 5, 6 TO 7, 8 TO 9, 4 TO 10.
 6. TEST INDICATES SELECT IN.
 7. E1-LINK # 22 AWG.

MODEL	OUTPUT A	OUTPUT B	DEC. SPEC #
6574-1	15V. 4A	20V. 4A	12-03185-2
6574-2	15V. 4A	20V. 4A	12-03185-2
6574-3	0V. 4A	15V. 4A	12-03185-3
6574-4	15V. 4A	20V. 4A	12-03185-4
6574-5	15V. 4A	20V. 4A	12-03185-5

MODEL	R3	R1	R2	R12	R13
6574-1	1K	15K	2.2K	1.2K	1.2K
6574-2	1K	15K	2.2K	1.2K	1.2K
6574-3	1K	15K	2.2K	1.2K	1.2K
6574-4	1K	15K	2.2K	1.2K	1.2K
6574-5	1K	15K	2.2K	1.2K	1.2K

FIELD SERVICE TECHNICAL MANUAL

Option or Designator

POWER SUPPLIES
(Deltron)12 Bit 16 Bit 18 Bit 36 Bit **digital**CIRCUIT SCHEMATICS FOR THE DELTRON POWER SUPPLIES
(Continued)Tech Tip Pwr. Sup. TT-1
Number

Title

USED BY DEC.

Processor Applicability

All

Author George Chaisson

Rev 0

Cross Reference

Approval Bill Cummins Date 7-31-72

MODEL	OUTPUT A	OUTPUT B	DEC SPEC.#
6575-1	10V, 1.5A	15V, 1.5A	12-03185-1
6575-2	15V, 1.5A	15V, 1.5A	12-03185-2
6575-3	20V, 1.5A	15V, 1.5A	12-03185-3
6575-4	15V, 1.5A	15V, 1.5A	12-03185-4
6575-5	20V, 1.5A	15V, 1.5A	12-03185-5
6575-6	20V, 1.5A	10V, 1.5A	12-03185-6
6575-7	20V, 1.5A	10V, 1.5A	12-03185-7

MODEL 6575-6 DEC.#12-03185-6 ARE WIRED FOR 105 TO 125V OPERATION, DEC.#12-03185-6 FOR 210 TO 250V OPERATION WIRE PER MODEL 6575-7.

MODEL	TRANSFORMER TAB	TRANSFORMER JUMPERS
6575-1	T10I-5-T10I-7	T10I-1 TO T10I-1A T10I-2 TO T10I-2A
6575-2	T10I-4-T10I-7	T10I-1 TO T10I-1A T10I-2 TO T10I-2A
6575-3	T10I-3-T10I-7	T10I-1 TO T10I-1A T10I-2 TO T10I-2A
6575-4	T10I-4-T10I-7	T10I-1 TO T10I-2A
6575-5	T10I-3-T10I-7	T10I-1 TO T10I-2A
6575-6	T10I-3-T10I-8	T10I-1 TO T10I-1A T10I-2 TO T10I-2A
6575-7	T10I-3-T10I-8	T10I-1 TO T10I-2A

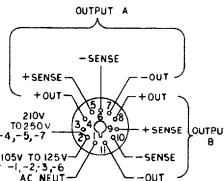

6575-7	3.3K	1.5K	2.2K	560Ω	7.87K	1K
6575-6	3.3K	1.5K	2.2K	560Ω	7.87K	1K
6575-5	3.3K	2.7K	2.2K	1.2K	7.87K	4.64K
6575-4	2.7K	2.7K	1.2K	1.2K	4.64K	4.64K
6575-3	3.3K	2.7K	2.2K	1.2K	7.87K	4.64K
6575-2	2.7K	2.7K	1.2K	1.2K	4.64K	4.64K
6575-1	1.5K	2.7K	560Ω	1.2K	1K	4.64K

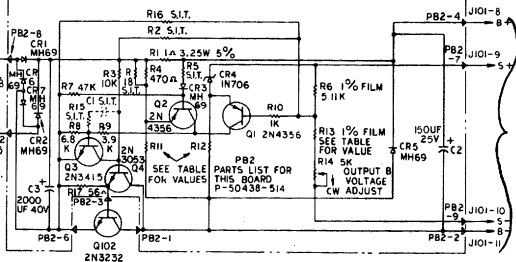
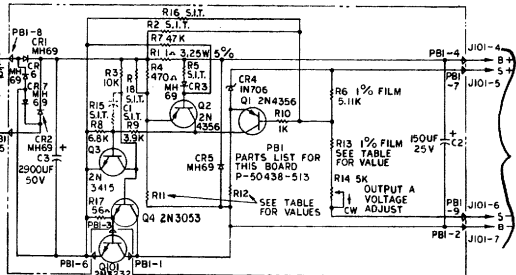
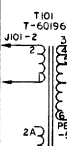

NOTES:

1. RESISTOR WATTAGE .5 WATT UNLESS OTHERWISE INDICATED.
2. ALL POTENTIOMETERS ARE WIREWOUND.
3. RESISTORS ABOVE 2 WATTS ARE WIREWOUND.
4. RESISTOR TOLERANCE: COMP. ±10%; WIREWOUND ±10%; UNLESS OTHERWISE INDICATED.
5. IF REMOTE SENSING IS NOT USED CONNECT 4 TO 5, 6 TO 7, 8 TO 9, & 10 TO 11.
6. S.I.T. - INDICATES SELECT IN TEST.

Reprinted by permission of
Deltron Inc.
Philadelphia 33, PA.

Output A

Output B

Title						POWER CORD LENGTH		Tech Tip Number		PWR SUP-TT-2	
All						Processor Applicability		Author		H. Long	
y								Rev		0	
						Approval		D. Zereski		Date	
								Date		9-14-72	
Cross Reference											

In order to obtain U.L. Approval for our systems, we must reduce the length of the power cord from 25 feet to 15 feet (external to cabinet).

Henceforth, please inform customers desiring physical installation data that the standard length of power cord is fifteen (15) feet.

/mt

Title						DRAWING ERRORS IN 54-09728 and 54-09728YA SCHEMATIC AND PARTS LIST.		Tech Tip Number		PWR SUP-TT-3	
All						Processor Applicability		Author		Jeff Blundell	
8M						8F		11/05		11/10	
						Approval		Frank Purcell		Date	
								Date		11/20/72	
Cross Reference											

ECO 5409728-6A field retrofits Rev. B and Rev C supplies with a new type crowbar zener if the supply has a history of blowing fuses.

However, no drawing change is officially called out to the schematic, since engineering feels that creating a Rev. B2 and C1 will add more confusion than we have right now.

If you have a supply that blows its +5 fuse (15 Amp pico fuse DEC Part Number 12-10929), then implement this ECO by changing D12 to an 11-11205 (5.7 volt 2% zener diode) AND MARK UP THE SCHEMATIC AND PARTS LIST TO REFLECT THE CHANGE!!

P.S. The DEC Part Number for the other fuse (10 amp) is 12-10929-01.







COMPANY CONFIDENTIAL

digital	FIELD SERVICE TECHNICAL MANUAL				Option or Designator
	12 Bit <input checked="" type="checkbox"/>	16 Bit <input checked="" type="checkbox"/>	18 Bit <input checked="" type="checkbox"/>	36 Bit <input checked="" type="checkbox"/>	POWER SUPPLIES

Title				Tech Tip	
DEC POWER CONNECTOR INFORMATION				Number PWR SUP TT-04	
Processor Applicability		Author IRVING PATON	Rev B	Cross Reference	
All X		Approval ART ZINS	Date 4/18/73		









As of February 1, 1973, we will be shipping several newly introduced power plugs and receptacles on our equipment. The following information should be helpful to DEC field personnel when assisting customers with site preparation, procuring power connectors, and performing installation of equipment.

A chart which details each of the new electrical plugs and receptacles follows. The National Electrical Manufacturers' Association (NEMA) designation and the DEC part number are given for each applicable plug and receptacle. In the diagrams: G is ground, W is neutral, X is line 1, Y is line 2, and Z is line 3.

SOURCE	PLUG	RECEPTACLE	USED ON
120V 15A 1 PHASE	 NEMA # 5-15P DEC # 90-08938	 5-15R 12-05351	All 120V Table Top Computers. Standard 120V low current distribution. 120V TU10 units. Most 120V terminal devices.
120V 30A 1 PHASE	 NEMA # L5-30P DEC # 12-11193	 L5-30R 12-11194	All 120V standard cabinet mounted equipment except: 11/45 & PDP-10 processors.
120/208-240V 20A 2 PHASE	 NEMA # L14-20P DEC # 12-11045	 L14-20R 12-11046	120V PDP-11/45 processor cabinet only. Won't be used until March 1, 1973

COMPANY CONFIDENTIAL

Title DEC POWER CONNECTOR INFORMATION						Tech Tip CPL	
						Number PWR SUP TT-04	
Processor Applicability			Author IRVING FATON		Rev A		Cross Reference
All X			Approval ART ZINS		Date 4-18-73		

SOURCE	PLUG	RECEPTACLE	USED ON
120/208V 20A 3 PHASE Y	 NEMA # L21-20P DEC # 12-11209	 L21-20R 12-11210	60 HZ PDP-10 processor cabinet. 60 HZ RM10 drum 60 HZ RP02/RP03
240V 15A 1 PHASE	 NEMA # 6-15P DEC # 90-08853	 6-15R 12-11204	All 240V table top computers. Standard low current 240V distribution Most 240V terminal devices. 240V TU10.
240V 20A 1 PHASE	 NEMA # L6-20P DEC # 12-11192	 L6-20R 12-11191	All 240V standard Cabinet mounted equipment except PDP-10 processor
240/416V 20A 3 PHASE Y	 NEMA # NOT NEMA DEC # 12-09010	 NOT NEMA 12-11259	50 HZ PDP-10 processor. 50 HZ RM10 drum 50 HZ RP02/RP03

COMPANY CONFIDENTIAL

digital	FIELD SERVICE TECHNICAL MANUAL				<i>Cpl</i> Option or Designator
	12 Bit <input checked="" type="checkbox"/>	16 Bit <input checked="" type="checkbox"/>	18 Bit <input checked="" type="checkbox"/>	36 Bit <input checked="" type="checkbox"/>	POWER SUPPLIES

Title PDP-11/45 POWER REQUIREMENTS				Tech Tip Number PWR SUP TT-05	
All Processor Applicability		Author IRVING PATON		Rev C	
45		Approval ART ZINS		Date 4/13/73	
Cross Reference					

There seems to be some uncertainties concerning the power requirements for the new type four blade twist-lock plug and receptacle which we are now using on the 120 volt versions of the PDP-11/45 processor cabinet . * The following information is intended to clear up these uncertainties.

Figure 1 shows the diagrams for this plug and receptacle; it also gives the National Electrical Manufacturers Association (NEMA) designations, the DEC numbers, and the part numbers of one of our vendors (HUBBLE). In the diagrams, G is ground, W is neutral, X is line 1 and Y is line 2.

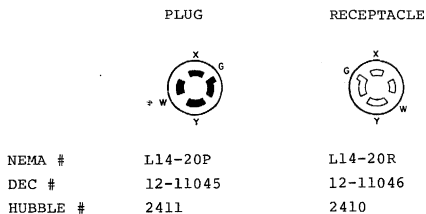

FIGURE 1.

*For information on the 861 power controller which distributes the power from this plug, refer to: 861-A,B,C POWER CONTROLLER Maintenance Manual (DEC-00-H861A-A-D).

COMPANY CONFIDENTIAL

Title		PDP-11/45 POWER REQUIREMENTS		Tech Tip	
All		Processor Applicability		Number PWR SUP TT-05	
45		Author IRVING PATON		Rev B	
		Approval ART ZINS		Date 4/13/73	
Cross Reference					

For the above mentioned use, either of two types of power systems may be used to provide power to this receptacle. One type of power system is shown in Figure 2.

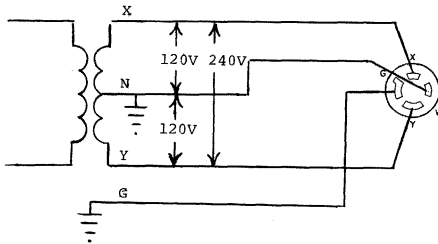

FIGURE 2.

This type of power is generally referred to as split phase or two phase (180° displaced), 120/240 V. It is a center tapped transformer with 120 V potential between the center tap and either of the other two legs. Also, a 240 V potential exists between the two outside legs of the transformer.

COMPANY CONFIDENTIAL

digital	FIELD SERVICE TECHNICAL MANUAL				Option or Designator
	12 Bit <input checked="" type="checkbox"/>	16 Bit <input checked="" type="checkbox"/>	18 Bit <input checked="" type="checkbox"/>	36 Bit <input checked="" type="checkbox"/>	POWER SUPPLIES

Title PDP11/45 POWER REQUIREMENTS				Tech Tip Number PWR SUP-TT-5	
All Processor Applicability		Author IRV PATON		Rev B	
45		Approval ART ZINS		Date 04/13/73	
Cross Reference					

Figure 3 shows the other type of power system which may be used for this receptacle.

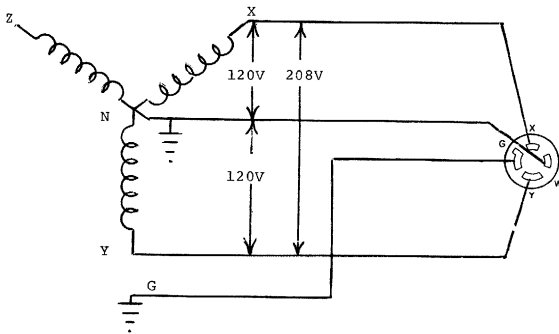

FIGURE 3.

This type of power system is referred to as 3 phase Y (120° displaced), 120/208V. 120V exists between neutral and any of the three other legs (X,Y, or Z), and 208V exists between any two of the outer legs of the diagram, i.e., X and Y, X and Z, or Y and Z. Although the diagram shows the X and Y connections as being the two phases used for the receptacle, in actuality, any two of the three phases shown (this includes Z) may be used.

COMPANY CONFIDENTIAL

Title PDP-11/45 POWER REQUIREMENTS					Tech Tip Number PWR SUP TT-05		
All	Processor Applicability				Author IRVING PATON	Rev C	Cross Reference
	45				Approval ART ZINS	Date 4/13/73	

Some general guidelines to follow concerning this receptacle are:

1. All electrical wiring must conform with the National Electric Code (NEC).
2. The ground terminal on the receptacle will normally have a green colored screw; the neutral terminal will be white or silver colored; and the "hot" terminals will be brass colored.
3. Under the NEC (in the U.S. only), the color coding for the neutral wire is either white or gray, and the ground wire is solid green, green with one or more yellow stripes, or bare. There are no specified colors for the "hot" wires.
4. Even though 208 or 240 volts is available at this receptacle, the PDP-11/45 doesn't use it; instead, it simply distributes the load as evenly as possible between the phases. However, the two phases used to supply this receptacle must be either 120° or 180° apart to assure that the neutral conductor never carries over 20 amperes of current, as this would cause the circuit breakers within these devices to trip.

COMPANY CONFIDENTIAL

digital	FIELD SERVICE TECHNICAL MANUAL				Option or Designator
	12 Bit <input checked="" type="checkbox"/>	16 Bit <input type="checkbox"/>	18 Bit <input checked="" type="checkbox"/>	36 Bit <input checked="" type="checkbox"/>	POWER SUPPLIES

Title	Explanation of 54-09728 and 54-09728YA Regulator Etch Rev.	Tech Tip Number	PWR SUP-TT-6
All	Processor Applicability	Author D. Dickhut	Rev \emptyset
8M 8F 05 10 35	11/11/11/10/35	Approval C. Dewey	Date 4/4/73
			Cross Reference

This basic supply, 54-09728, is used in the following devices: 8M, 8F, 11/05 and 11/10 (both 5 1/4 and 10 1/2 box versions), 11/35, ME11-L, and H740D (Rack mounted version of the 54-09728). Some of these devices require a minimum etch revision because the rating of the 54-09728 differs with each etch revision. Presently there are three etch revisions in the field: B, C, and D. A 54-09728YA version also exists specifically for the ME11L. The ME11L needs more -15V capacity and this YA version uses the same etch rev C board. The YA designator really does not indicate a different etch revision but that the circuit schematic (CS) is different. The only difference compared to a normal circuit schematic 54-09728 etch rev C is that the YA has R19 changed to a .08 ohm from a .1 ohm. This allows more current capacity on the -15V. (The etch rev D uses a .06 ohm for R19 and has a greater capacity than the YA).

In general, an etch rev D or later regulator can be used on any device for module swap purposes. It has sufficient ratings to handle every application. The YA version can be used in any device that originally used a B, C or YA. The etch rev C can be used in any device that originally used a C. An etch rev C cannot replace a YA or D, nor can a YA replace a D. The 54-09728 is part of the H750 power supply and etch rev D or later is required in the H750 which is used on 11/05 and 11/10 (10 1/2 box version), 11/35, and the new Ball expansion box, BallBA and BB. The following table should be helpful:

DEVICE	ETCH REV	CAN BE REPLACED WITH
	ORIGINALLY SHIPPED	
1. 8M, 8F	B	B, C, YA, D or later
2. 11/05 and 11/10 (5 1/4 inch box version)	C	C, YA, D or later
3. ME11L	YA	YA, D or later
4. H740D	C	C, YA, D or later
5. H750 (See Note)	D	D or later

Note: H750 is used on 11/05 and 11/10 (10 1/2 version), 11/35, and BallBA and BB.

COMPANY CONFIDENTIAL

Title Explanation of 54-09728 and 54-09728YA Regulator Etch Rev. (Continued)						Tech Tip Number PWR SUP-TT-6	
Processor Applicability						Author D. Dickhut	
All						Rev β	
						Approval C. Dewey	
						Date 4/4/73	
Cross Reference							

Domestically, the Maynard Module Repair Depot has usually been sending out nothing but YA versions, since they can be used on everything except those that require etch rev D or later. The reason for this is that it is too cumbersome to stock C and YA. Consequently some devices such as 5 1/4 inch 11/05's may have a YA version swapped into them. Presently Branches have either rev C or YA versions in their spares kits. Eventually Logistics will distribute etch rev D versions to Branches. Then the etch rev D should be saved and used on only those devices that require it, and the rev C or YA used on those devices that originally shipped with it. 8 M's and 5 1/4 inch 11/05's will be found with etch rev D in them because of normal product improvement. If this supply is swapped it should be replaced with an etch rev C or YA and save the Branches etch rev D spare for a device that requires it. A long term goal is to eventually phase out the rev C and YA and use nothing but etch rev D or later as replacements from the Maynard Repair Depot.

A word of caution is required. Earlier etch revs that are substituted in a device that requires an etch rev D or later may seem to work because the load may not be heavy in some cases. However over the long term, the transformer may start to overheat with serious consequences. So even if the swap seems to work, do not use this practice and swap the appropriate etch rev in the device.

Title SHORTS ON THE 5409728 REGULATOR						Tech Tip Number PWR SUP TT-7	
Processor Applicability						Author DUANE DICKHUT	
All						Rev 0	
						Approval WAYNE GRUNDY	
						Date 6/14/73	
Cross Reference							

There are three areas on the 54-09728 that are prone to shorting. They are as follows:

1. The two large 24000 MMF capacitors, C1 and C2, are mounted directly to the etch board and are prone to having their clear insulation punctured by component leads protruding from the other side of the module. ECO 54-09728-00010 solves this problem by placing foam tape between the capacitors and the etch board so component leads no longer puncture the insulation. This ECO also prevents these two capacitors from moving in a vibration environment. This ECC applies to all etch revisions.

digital	FIELD SERVICE TECHNICAL MANUAL				Option or Designator
	12 Bit <input type="checkbox"/>	16 Bit <input checked="" type="checkbox"/>	18 Bit <input type="checkbox"/>	36 Bit <input type="checkbox"/>	POWER SUPPLIES
Title SHORTS ON THE 54-09728 REGULATOR					Tech Tip Number PWR SUP-TT-7
All	Processor Applicability		Author DUANE DICKHUT	Rev A	Cross Reference
			Approval WAYNE GRUNDY	Date 6/14/73	

2. This problem applies to all etch revision C and some etch revision D regulators. Late etch Rev D and all etch Rev E regulators have plated-thru holes that solve this problem. Because of no plated thru holes, the two #10 screws that hold the 6000 MF +5V capacitor C7 to the module also must carry the full load current. This connection has been poor on the capacitor side of the board where the "+" terminal of C7 touches the etch. To improve this connection, remove the two # 10 x 1/4 screws and use two # 10 x 5/16 screws, such as part number 90-06070-1. This extra length is needed in order to ensure sufficient thread contact with the capacitor. Use the existing #10 internal tooth lockwasher under the head of the screw and also add another #10 internal tooth lockwasher (part number 90-06635) between the "+" and "GND" terminals of C7 and the etch board. This extra washer between each terminal and the etch board will improve the electrical connection. Otherwise a high resistance connection develops and the surrounding etch and board turns brown.

The 3000 MF capacitor, C14, which is next to C7, sits on the -15V. The two # 10 x 1/4 screws that hold it to the board should also be replaced with the longer # 10 x 5/16 screws. This will ensure that any vibration will not loosen the screws. Do not add the additional internal tooth lockwashers to the terminals of C14 as there is not enough clearance to adjacent etch.

3. This problem applies only to etch revision C regulators. The terminal closest to C7 of choke L1 (This is the +5V choke, part no. 16-10717) has a hex nut on it between the choke and the etch board. Due to board tolerances, the hex nut can short to the adjacent etch run. To solve this problem, remove L1 from the board. It is held to the board by two kepnuts on the discrete component side. Locate the etch running from the positive end of C5 (39mFd) that passes too close to the nut, and remove the etch from the board. Replace the etch with a length of insulated wire running on the component side from C5 to the cathode of D9.

COMPANY CONFIDENTIAL

Title SHORTS ON THE 54-09728 REGULATOR						Tech Tip Number PWR SUP-TT-7		
All	Processor Applicability					Author DUANE DICKHUT	Rev A	Cross Reference
						Approval WAYNE GRUNDY	Date 6/14/73	

3. Remount L1, and check that all screws and nuts holding chokes, capacitors and transistors to the board are tightened securely. (16 inch pounds is the spec.) Do not overtighten, some capacitor screws will strip at 22 inch pounds, and the choke studs will break at about 25 inch pounds.

Title 54-09728 TRANSFORMER VARIATIONS BETWEEN 8/M and 11/05						Tech Tip Number PWR SUP-TT-8		
All	Processor Applicability					Author DUANE DICKHUT	Rev 0	Cross Reference
						Approval WAYNE GRUNDY	Date 6/18/73	

The AC line transformer used in conjunction with the 54-09728 regulator has two variations; part number 1610601-2 is used on PDP-8/M, and part number 1610601-1 is used on PDP-11/05 and ME11-L. The difference between the two is the direction of the screws that hold the laminations together. The 8/M transformer has the screw heads on the same side that the leads exit from. The 11/05 transformer has the screw heads on the opposite side from the leads. It is recommended that these screws not be removed and turned around for interchangeability between the 8/M and 11/05; use the correct version for replacement. For 11/05 and ME11L, the 1610601-1 transformer is stocked with connectors already attached to the leads. This transformer assembly is part number 70-08726, is stocked in Maynard, and will save you time when replacing it.

Some transformers of each variation are potted and others are not. This is simply a difference in the way each vendor manufactures the transformer; the potted and unpotted type are identical.

digital	FIELD SERVICE TECHNICAL MANUAL				Option or Designator
	12 Bit <input checked="" type="checkbox"/>	16 Bit <input checked="" type="checkbox"/>	18 Bit <input checked="" type="checkbox"/>	36 Bit <input type="checkbox"/>	POWER SUPPLIES

Title H721 POWER SUPPLIES					Tech Tip Number		Power Supplies
All Processor Applicability					Author W. Freeman	Rev 0	Cross Reference
8	11	15			Approval W.E. Cummins	Date 11/14/73	

H721 POWER SUPPLIES

The 110 VAC 4A available on TB2-3 & 4, 5 & 6 are auto tap outputs, and they should not be used to supply power to grounded devices. If the input for the H721 is 220 VAC, TB 2-3 (110 VAC) output is taken from the "source" side of the AC input and may be 220V above a real earth ground. Refer to ECO #H721-00004 for correction.

Title PDP8E/UL INFORMATION					Tech Tip Number		TT#10
All Processor Applicability					Author W. Freeman	Rev 0	Cross Reference
8E					Approval W.E. Cummins	Date 11/14/73	

Our PDP-8e power supplies are now UL approved. Field conversion of power supplies 110/240 would nullify UL approval. It is therefore recommended that field conversion be avoided.

Title 54-9728 P.C. REGULATOR BOARD COMPATIBILITY					Tech Tip Number		PWR.SUP-TT-11
All Processor Applicability					Author J. Blundell	Rev 0	Cross Reference
8M	8P				Approval F. Purcell	Date 1-14-74	

This Tech Tip is issued for cross reference purposes.

Title 54-9728 - NOTES ON RECENT ECO'S					Tech Tip Number		PWR SUP-TT-12
All Processor Applicability					Author J. Blundell	Rev 0	Cross Reference
8	11				Approval Jim Bray	Date 7/9/74	

A number of failure mechanisms have been noted on the 54-9728 Regulator Board used on the PDP8M, 8P, 11/05, 11/10, 11/35, H740 and H750 Power Supplies. These notes summarize the failures and indicate which ECO's or FCO's resolve the problems.

- 1) 24,000 MFD Input Filter Caps. (The Big Ones)
 - a) Any capacitor with a grey vinyl coating should be replaced. It is probably over full of electrolyte, and is liable to leak. Capacitors with clear coatings or blue coatings are alright.

Title 54-9728 - NOTES ON RECENT ECO's (CONT.)						Tech Tip Number	
Processor Applicability						PWR Sup-TT-12	
All		Author J. Blundell			Rev 0		Cross Reference
8 11		Approval Jim Bray			Date 7/9/74		PDP8M-TT-10

- b) The coating on the capacitor may be punctured by component leads or solder spikes. ECO#10 adds stand offs between the capacitor and the board and between the bracket and the board.

Parts	10-10702	Capacitor	2 per board
	90-9087-1	Tape	4 inches required
			per board
	90-9283	Spacer	2 per board

2) Heat Sinks

The earliest heat sinks used were golden colored. They were not insulated, and were only used on etch Rev B boards. Etch Rev B boards should be scrapped, they are no longer supported.

Starting with etch Rev C, a black heat sink was used. The black coating (which looks rather the color of pencil lead) is a very tough non electrically conductive film, and is all that is used to isolate the power transistors and diodes from the heat sink. NO MICA WASHERS ARE REQUIRED. Unfortunately, a number of inferior heat sinks have entered the system since September 1973. They may be recognized in two ways. The coating is a very smooth matte black (like lampblack) and the various holes through the heat sink have square edges (ie no countersinking or bevelling). These heat sinks, and these heat sinks only, require insulating washers under all the power transistors and diodes.

3) Q7 and Q23 (Little Green Power Transistors)

The collector connection for these transistors is made through the screw that mechanically fastens them to the heat sink. We now recognize that with certain combinations of time, temperature and pressure the G10 epoxy material of the board itself can be squashed, resulting in screw connections loosing torque and becoming loose. In an effort to make it easier to re-torque the screws for Q7 and Q23 ECO#12 replaced the nut with a length of threaded spacer. The idea was too good, it became possible for so much torque to be applied that the transistor itself became physically damaged. ECO#19 removed the threaded spacer and long screw, and returned the board to the way it was.

On a working supply in the Field the best course of action is not to touch this area. If the supply has spacers, let them be. Never retorquer these screws by turning on the spacer. Always do it from below, using a small philips screwdriver and holding the spacer (or the nut) in your fingers. Ideal torque for these #4 screws is seven inch pounds, and its almost impossible to get more than this using the small screwdriver/fingers technique.

Depots should examine the power transistors for distortion of the transistor mounting tab, or any sign of a fracture between the tab and the green plastic. If either transistor shows signs of damage both should be replaced, and the spacers also replaced with nuts.

digital	FIELD SERVICE TECHNICAL MANUAL				CPL
					Option or Designator
12 Bit <input checked="" type="checkbox"/>		16 Bit <input checked="" type="checkbox"/>		18 Bit <input checked="" type="checkbox"/>	
				36 Bit <input type="checkbox"/>	
					POWER SUPPLIES

Title 54-9728 - NOTES ON RECENT ECO's (CONT.)				Tech Tip Number PWR SUP-TT-12	
All Processor Applicability			Author J. Blundell		Rev 0
8 11			Approval Jim Bray		Date 7/9/74
				Cross Reference PDP8M-TT-10	

Parts Required

90-06013-1	#4-40 X 1/2" Screw	Quantity 2
90-06557	Keq-Nut	Quantity 2

If Q7 (or Q23 fails,) it will almost certainly take the following components with it.

13-00229	100 Ohm 1/4W Resistor	Quantity 1
15-10706 (15-10705)	XA55 (XA05) Transistor	Quantity 2 probably

ECO#12

ECO#12 is of major importance, and adds components to prevent the single most significant failure seen on the earliest (etch Rev C and some D) boards.

The problem is the time/temperature/pressure related relaxation of the board material in the area of the +5 volt choke and output capacitor mounting studs/screws.

To ensure a good electrical connection the torque of these screws and nuts must be more than about seven inch pounds. At less than six there is a definite increase in electrical resistance, more heat is generated, and the board will relax more, starting a positive feedback loop that terminates with either a burnt board or a blown fuse (because the crowbar fires).

ECO 12 adds two "THERMAL STRAPS" that do two jobs. Primarily they dissipate any heat generated at the junction, and as a secondary function they spread the tension of the screws over a larger area of the board surface. Other benefits include protection of the etch from damage by the lockwashers and the additional parallel electrical path for the current.

The straps should be added to all boards, since without them there is a definite chance of a loose connection developing in time and either discoloring the board or blowing the fuse.

Parts

55-10892-1	Thermal Strap #1	Quantity 0 (1)
55-10891-1	Thermal Strap #2	Quantity 1
90-96658	Flat Washer	Quantity 10

The flat washers are added under the heads of the screws securing the power transistors and diodes, again to spread the load and reduce the amount of board relaxation.

Note: that it may not be possible to install them all. Because (depending on the way the board was cut during manufacture) some of them may short to mounting tabs on the chassis, or to the chassis itself via the etched letters G or U of "Regulator Board" under Q22.

Title 54-9728 - NOTES ON RECENT ECO's (CONT.)						Tech Tip	
All Processor Applicability						Number PWR-SUP-TT-12	
Author J. Blundell				Rev 0		Cross Reference	
Approval Jim Bray				Date 7/9/74		PDP8M-TT-10	

Thermal strap #1 interfered with chassis metalwork when trying to mount the 54-9728 in the H750 chassis. The first attempt at obtaining compatibility was ECO 74-09723-002 which reworked the chassis to reposition the mounting lug. The procedure used was impractical for field retrofit, and ECO 74-09723-003 cancelled the previous one, while ECO 55-10892-002 obsoleted the old thermal strap and generated a new one called the 55-11105-1. ECO 54-09728-0020 orders this new strap to be used on the regulator board.

Note that there is no reason why the old #1 strap (55-10892) should not be used on the field to update 8M and 11/05 (and similar) processors. The only time the 55-1105 is absolutely necessary is in an unmodified H750 chassis. Production and the depots will use 55-1105's as soon as they are available, but the 55-10892 will continue to be used for some time until the new strap is readily available.

ECO's 13,17,17A,17B,18 and 18A

The net effect of these changes is to define C16, the +15 volt output capacitor, as being preferably a 100 mfd 25 volt working aluminum electrolytic, with an acceptable second choice substitute being a 22 mfd 35 volt tantalum capacitor. The one component definitely not desired is the 100 mfd 20 volt tantalum added as part of ECO#13. Note that ECO 13 applies only to etch Rev E boards, and can be recognized by the resistor/capacitor combination (the capacitor is a ceramic disk type, and will only be present if ECO 13 has been installed) mounted in place of R56. R56 is located near the heat sink end lug of the +5 volt choke between the two one microfarad capacitors.

Policy on Field Retrofit of ECO's.

In general the preferred North American method of ECO installation on the 54-9728 is by cycling the board back through the depot. One major reason for this is that only the depot has the test equipment needed to properly checkout the board after electrical rework. It is difficult to measure current limit points, crowbar trip voltage, AC/DC to time relationship, efficiency, and other parameters that are not directly output voltage related on the field.

The only exceptions to this policy have concerned the mechanical changes (ECO's 10 and 12), which are to be field installed where possible, certainly in contract systems. (Warranty systems at this time will have had these changes installed by production).

The field retrofit instructions for ECO#12 have been expanded to cover many of the points that should be considered when working around this board, and a study of them will be of benefit to anyone who may need to work in the power distribution area of products using the 54-9728.

digital	FIELD SERVICE TECHNICAL MANUAL				Option or Designator
	12 Bit <input checked="" type="checkbox"/>	16 Bit <input checked="" type="checkbox"/>	18 Bit <input checked="" type="checkbox"/>	36 Bit <input checked="" type="checkbox"/>	R405 to RF08

Title SELECTION OF COMPONENTS FOR USE WITH CRYSTALS				Tech Tip Number R405-TT-1	
All Processor Applicability		Author Ralph Boehm	Rev 0	Cross Reference	
X		Approval Chuck Sweeney	Date 9/18/74	M405-TT-2	

This Tech Tip is issued for cross reference purposes only.

Title RF08 OPERATION ON PDP-8L				Tech Tip Number RF08-TT-1	
All Processor Applicability		Author W. Freeman	Rev	Cross Reference	
	8L	Approval W. Cummins	Date 7-31-72	M405-TT-2	

Certain software routines can cause DRL's in the ~~ECO 019~~ ^{RF08 019 & 029} after the installation of RF08 ECO 0019. If this problem is evident, the installation of RF08 ECO 0029 will ~~correct~~ ^{work} at the problem.

TECH TIP

Title HARDWARE PROBLEMS EXISTING WITH RF08 and RSO				Tech Tip Number RF08-TT-2	
All Processor Applicability		Author C. Cline	Rev 0	Cross Reference	
		Approval W. Cummins	Date		

In the near future ECO's will be issued to correct the following list of problems:

- 1) When doing a cross disk transfer, address zero on track zero of the extended disk is not accessed and all data is placed in its proper address plus one. However, if the beginning of the transfer is at zero on track zero of the extended disk, the transfer is normal.
- 2) When doing a write with WLS \emptyset set as the EMA increments from 7 to 10. 17 to 20, 37 to 40, a spike is generated on the interrupt line causing an undefined interrupt.
- 3) When deselecting and then reselecting an extended disk unit within 150 us, a false PCA signal is generated. If an LMAP occurs during this time after reselection of the extended disk, the 256 us delay is inhibited and DRE is immediately set. This problem can be exhibited by running Random Track Address Test on an extended disk.
- 4) Problems with motor stopping long after installation caused by R1 of the motor control: R1 is passing current as long as the motor is running; therefore, developing excessive heat leading to an eventual breakdown.

Carl Cline/January 1971

SUPPLEMENTAL ACTION
TAKEN

ECO RF08 029

Title RF08 SYNC ADJUSTMENT						Tech Tip Number RF08-TT-3		
All	Processor Applicability					Author C. Cline	Rev 0	Cross Reference
	8I					Approval W. Cummins	Date 7-31-72	

Problem: During address test of disk data, the first 17 addresses may generate errors. The errors are due to photo sync and LDMP not occurring at the same time. This forces the disk control to wait 16 words rather than setting DRE immediately. The present solution is to adjust photo sync to 110 microseconds.

This problem is more apparent on PDP-12 and may have to be adjusted to 125 us.

Title RF08 (Disk)						Tech Tip Number RF08-TT-4		
All	Processor Applicability					Author C. Cline	Rev 0	Cross Reference
	8E	8I	8L			Approval W. Cummins	Date	

The quality of a disk surface can be altered by a build up of dirt or by handling of the entire disk assembly. This condition can be detected in time to save the surface from eventual destruction and long down times.

The detection of dirt can generally be confirmed with the use of a scope. The following method should be used:

- A) Sync scope "on line".
- B) Set time/cent. to 5 ms.
- C) Set volts/cent. to .2V (using X10 probe).
- D) Place probe on RS08 location A02, pin T.
- E) One of the following sketches should be observed.

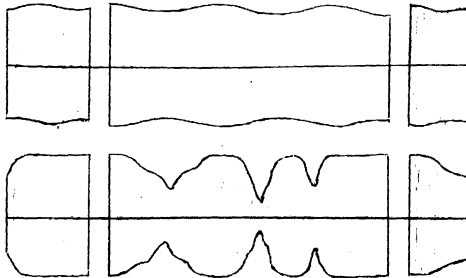

- F) The first sketch indicates a good surface, only minor dips will be observed in a revolution.
- G) The second sketch indicates that the surface is dirty and has started scoring the surface. The display on the scope will have sharp jagged decreases in amplitude. Where a good surface will have a minor and more gentle decrease and increase.
- H) This procedure should be repeated on all timing tracks (three) and on randomly selected data tracks.

digital	FIELD SERVICE TECHNICAL MANUAL				Option or Designator
	12 Bit <input checked="" type="checkbox"/>	16 Bit <input type="checkbox"/>	18 Bit <input type="checkbox"/>	36 Bit <input type="checkbox"/>	RF08
Title RF08 (Disk) (Continued)					Tech Tip Number RF08-TT-4
All	Processor Applicability		Author C. Cline	Rev 0	Cross Reference
	BE	8I	8L	Approval W. Cummins	

This method will give you the general condition of the surface, however, if the diagnostic still gives error on a specific track and address this problem should be confirmed before replacing disk. Only a minor adjustment may be required to correct the problem.

In order to look at one word on my data track use the following method:

- A) Load Disk Data
- B) Load Address 201
- C) Start desired track in SR
Continue desired address in SR
Continue desired data in SR
Continue desired data in SR (usually all ones)
Continue 7001 in SR
This will read and write in the desired location.
- D) Halt Program
Load 200
Start 7201
This will read only the location selected previously; it may be necessary to put SR bit 3 to inhibit errors.
- E) Now with channel one, sync on ADC negative location B21 pin N in RF08.
- F) With channel two, and scope on alternate look at output of data amp in RS08 location A12T.
- G) You will now observe the data being retrieved for the desired word.
- H) If the decrease in amplitude is not catastrophic you may adjust it until there is a sliced output. (RS08 B12D and E)

If PM's are performed on equipment, it is a good idea to monitor any change in track amplitude from the previous PM.

COMPANY CONFIDENTIAL

Title RF08 TIMING TRACK WRITER						Tech Tip Number RF08-TT-5		
All	Processor Applicability					Author W. Kochman	Rev 0	Cross Reference
	8	8E	8I	8L		Approval W. Cummins	Date 7-31-72	

New RF08 TTWs have a coarse adjustment pot instead of the 50 - 60 cycle switch. To use the new pot:

- 1) Find the middle position on the fine adjustment pot.
- 2) Press write and examine gap area.
- 3) Adjust the coarse adjustment pot while performing step 2 until the gap area is approximately 2 msec.
- 4) Adjust the fine adjustment pot while performing step 2 until the gap area is 500 - 550 usec.

Title NOTES ON RF08 TUNING PROCEDURE						Tech Tip Number RF08-TT-6		
All	Processor Applicability					Author W. Freeman	Rev 0	Cross Reference
						Approval W. Cummins	Date 7-31-72	

Use RF08 Disk Data Maindec 08-D5EA. When random errors occur on one or two tracks, it is better to run the data patterns on a selected track rather than run the entire 40-minute test. This may be done by loading address 0201 and starting with the switch register set to the desired track; now load address 0200 and start with 6000 in the switch register. The program will exercise the selected track with all data patterns and then jump to the incremental word count test (random data) exercise all tracks randomly, then return to the selected test track.

The selection of a specific track for testing makes adjustment procedures more efficient because the program can loop through the complete test in a few minutes. The effect of a slice control or amplifier adjustment can be observed very quickly, especially on the single track, but also on the other tracks as well.

Title OHM METER TESTING OF DISK HEADS IN RF/RS08-DF32						Tech Tip Number RF08-TT-7		
All	Processor Applicability					Author W. Freeman	Rev 0	Cross Reference
						Approval W. Cummins	Date 7-31-72	

digital	FIELD SERVICE TECHNICAL MANUAL				Option or Designator RF08
	12 Bit <input checked="" type="checkbox"/>	16 Bit <input type="checkbox"/>	18 Bit <input type="checkbox"/>	36 Bit <input type="checkbox"/>	

Title G285/G286 REVISIONS FOR USE IN RS08			Tech Tip Number RF08-TT-8
All Processor Applicability		Author Steve Gradie	Rev 0
8I		Approval w. Cummins	Date 7-31-72
			Cross Reference

Early revision G285's and G286's must be modified for proper operation in an RS08. The components shown on the component-side view drawings below must be the values and part numbers as indicated. Either module, so modified, will function properly in a DF32 or DS32.

These changes will bring the G285 to circuit revision A level as specified in ECO G285-00001 and the G286 to circuit revision B level as specified in ECO G286-00001. It should be noted that the revision level printed on the board is the "etch" revision level and differs from the "circuit schematic" revision level.

Steve Gradie June 1969

COMPANY CONFIDENTIAL

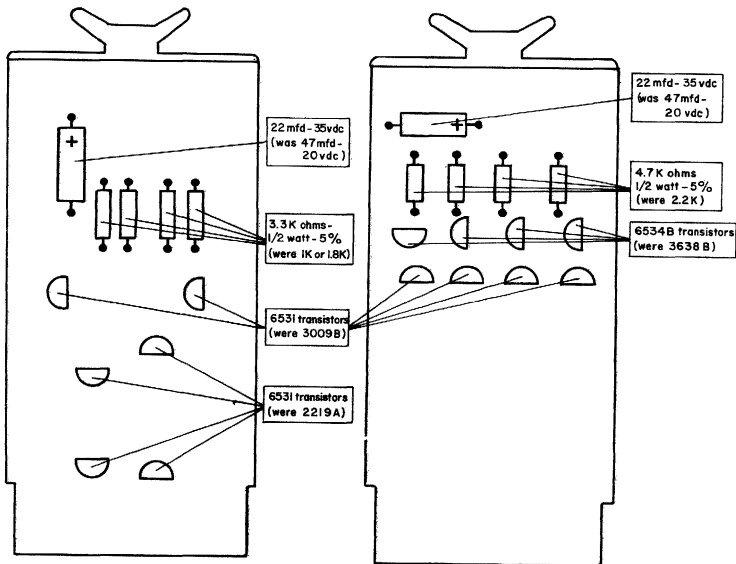

G285

G286

June 1969

Title AC POWER TO RF08/RS08						Tech Tip Number RF08-TT-9		
All	Processor Applicability					Author B. Freeman	Rev 0	Cross Reference
	8I					Approval W. Cummins	Date 7-31-72	

It is imperative that the AC power supplied to the RF08/RS08 be connected in proper phase relationship. Improper phasing or lack of a high quality ground can cause random, unexplainable errors in the processing of disk data. Refer to "AC" Power Specifications for Computer Installation" for an explanation of proper AC power wiring. Check with a scope for a signal on the white AC lead at the RS08 control; there should be none. A check at the RS08 motor fuse terminal should produce a 60-cycle sine wave. If these indications are reversed, it is an indication of phase reversal which must be corrected.

Title B163 MODULES IN RF08						Tech Tip Number RF08-TT-10		
All	Processor Applicability					Author W. Moroney	Rev 0	Cross Reference
	8I					Approval W. Cummins	Date 7-31-72	

The following slots in the RF08 were designed for B163 modules initially:

A23, A24, B3, B4, B7, B8, B25, B26, D7, D8; ECO RF08-00005 specifies that S123's should be installed instead. This is not a field retrofit ECO. The B163's will operate just as satisfactorily as the S123's.

Title RF08 Disk Data						Tech Tip Number RF08-TT-11		
All	Processor Applicability					Author L. Beyersdorfer	Rev 0	Cross Reference
	8I					Approval W. Cummins	Date 07/31/72	

Problem: RF08 disk data does not verify that IOT 6603 (DNAR) clears the AC.

Correction: Make the following changes to 08-D5EB.

<u>Location</u>	<u>Change to</u>	<u>Symbolic</u>
3174	7440	SZA
3175	7402	HLT/ERROR
3176	7200	CLA
3177	5756	JMP I READ

COMPANY CONFIDENTIAL

digital	FIELD SERVICE TECHNICAL MANUAL				Option or Designator
	12 Bit <input checked="" type="checkbox"/>	16 Bit <input type="checkbox"/>	18 Bit <input type="checkbox"/>	36 Bit <input type="checkbox"/>	RF08

Title RF08 TIMING TRACK WRITER				Tech Tip Number RF08-TT-12		
All	Processor Applicability			Author Bill Kochman	Rev 0	Cross Reference
	8	8E	8I	8L	Approval Frank Purcell	

New RF08 TTW's have a coarse adjustment pot instead of the 50-60 cycle switch. To use the new pot:

1. Find the middle position on the fine adjustment pot.
2. Press WRITE and examine gap area.
3. Adjust the course adjustment pot while performing Step 2 until the gap area is approximately 2 msec.
4. Adjust the fine adjustment pot while performing Step 2 until the gap area is 500-550 usec.

Title RF08, Ringing on BMB Lines				Tech Tip Number RF08-TT-13		
All	Processor Applicability			Author Crouch/Cline	Rev 0	Cross Reference
	8'S			Approval Frank Purcell	Date 07/31/72	

Excessive ringing on BMB lines may be encountered on systems with long I/O bus. The effect of this ringing will cause data bits to set the S206's in the "Memory Buffer Hold Register". In order to cure this problem, it is necessary to install two G795's, cable terminator cards, at the end of the BMB lines. These cards should be installed when above symptoms are observed.

COMPANY CONFIDENTIAL

Title RF08 System Crashes						Tech Tip Number RF08-TT-14	
All Processor Applicability		Author Rev		Cross Reference			
x				Approval H. Long	Date 08.17.72		

If ECO #RF08-00022 is installed without ECO#00024, system crashes may occur. Disk Data does not readily point to any selection problems, wherein a whole track of data may be entirely incorrect. Failure frequency is about 2 per hour.

Solution: Install these ECO's simultaneously.

Title INTERMITTENT INTERRUPT CRASHES						Tech Tip Number RF08-TT-15	
All Processor Applicability		Author Rev 0		Cross Reference			
8's	12			Approval H. Long	Date 8.17.72		

When adjusting PCA on an RF08 which is attached to a PDP-12 the following considerations must be complied with:

1. PCA duration is to be 120-130 microseconds.
2. The leading edge of PCA must fall midway between the last TAP in the Special Address area and the single TAP in the head switching gap.

SEE FIGURE 1

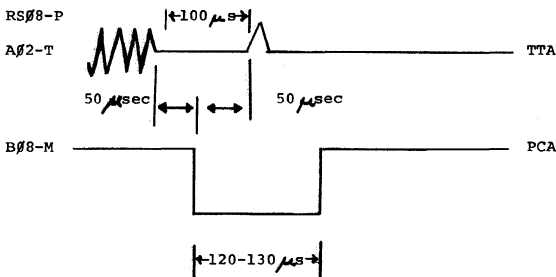

COMPANY CONFIDENTIAL

digital	FIELD SERVICE TECHNICAL MANUAL				Option or Designator
	12 Bit <input checked="" type="checkbox"/>	16 Bit <input type="checkbox"/>	18 Bit <input type="checkbox"/>	36 Bit <input type="checkbox"/>	RF08

Title "INCR MB" on Linc-8 with RF08's				Tech Tip Number RF08-TT-16	
All	Processor Applicability	Author	Rev	0	Cross Reference
X		Approval H. Long	Date	09/14/72	

On Linc-8's with RF08's installed, if problems are encountered with "INCR MB" being loaded down, check that the 3V clamp in the RF08 is removed.

Signal Name	From	To	Delete
-3V Clamp	C08V	C125	x

/mt

Title Run-away with INT pause set				Tech Tip Number RF08-TT-17	
All	Processor Applicability	Author Ralph Sliney	Rev	0	Cross Reference
X		Approval A. Shimer	Date	9/27/73	

When doing a disk write "6605" instruction, followed by a linc tape instruction, before disk transfer is complete, should no tapes be selected the processor is locked in "INT PAUSE" and a "DOL" is sensed by disk. Since there is no way of clearing "DRE" in this case, the disk will continue to write until "NXD" sets. The data written on the disk will be the same work.

This can be corrected by adding the "DRL" signal to the clear side of "DRE" add

D14N - D14P		A21F clear side
D14P - A15F		IOC DRE
D14R - A21F		

COMPANY CONFIDENTIAL

Title RF08 HEAD CABLE					Tech Tip Number RF08-TT-18		
All	Processor Applicability				Author Dave Grainger	Rev 0	Cross Reference
	8	8I	8L	8E	Approval Bill Freeman	Date 12/05/73	

Below is a chart which allows the serviceman to fix the position of a defective head or cable. The part number of the cables are also given.

25 Grams = Inside Heads

31 Grams = Outside Heads

PAD	TRACK	PAD	TRACK
1	00-07	9	100-107
2	10-17	10	110-117
3	20-27	11	120-127
4	30-37	12	130-137
5	40-47	13	140-147
6	50-57	14	150-157
7	60-67	15	160-167
8	70-77	16	170-177

CABLE

A17	70-6221-1
A18	70-6221-2
A19	70-6221-3
A20	70-6221-4

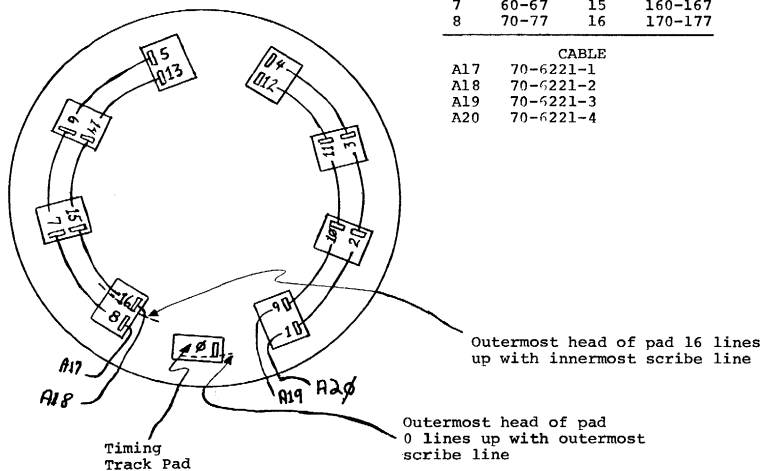

COMPANY CONFIDENTIAL

digital	FIELD SERVICE TECHNICAL MANUAL				Option or Designator
	12 Bit <input checked="" type="checkbox"/>	16 Bit <input type="checkbox"/>	18 Bit <input type="checkbox"/>	36 Bit <input type="checkbox"/>	RK01

Title 240V MOTORS				Tech Tip Number RK01-TT-1		
All	Processor Applicability			Author R. Boehm	Rev n	Cross Reference
	8			Approval D. Staube	Date 3-27-74	

The color coding on some of the 240V Replacement Spindle Drive Motors may be reversed. This can be quickly verified by checking the rotation of the spindle. If the direction of rotation is clockwise, reverse the yellow and red wires on the motor. The correct rotation should be counter clockwise.

Title RK01 DRIVE MOTOR REPLACEMENT				Tech Tip Number RK01-TT-2		
All	Processor Applicability			Author M. Doneski	Rev 0	Cross Reference
	8			Approval R. Boehm	Date 5/6/74	

The following procedure is for removal of the RK01 Disk Drive motor and related parts. Some considerations before starting the job:

If you order a new motor be sure that you also order a new Motor Start Capacitor, a new Pulley with screws, a new Drive Belt, and a new Mounting Plate. The reason for ordering these new parts is because the vendor has changed the motor they are supplying:

Old Style = 1800 RPM
New Style = 3600 RPM

A new motor will not work with old Start Capacitor or Pulley (too fast).

DEC PART NO.

PRRTEC PART NO.

29-20160 Motor	519-0003
29-20161 Mounting Plate	105325-02
29-20162 T Belt	610-0015
29-20163 Pulley	106064-01
29-20164 Capacitor	140-5050

1. Remove the RK01 from the cabinet; set it on a work bench.
2. Remove the Left Side Shroud.
3. Remove Drive Belt.
4. Loosen and remove Pulley from the motor shaft.
5. Loosen and remove four (4) screws holding the motor to the motor mounting plate.
6. Pull Motor up from cavity and lay it on the Disk Deck, remembering that the power wires are still connected.
7. Before performing the next step, cautions are in order. DO THIS STEP VERY CAREFULLY: Loosen and remove the three (3) screws holding the Motor Mounting Plate. This Plate is held under spring tension. If it snaps out, it may break wires or TB4. Remove plate.
8. Disconnect Motor Wires at Terminal TB4, noting which wires are connected to which Terminal Post.

Title RK01 DRIVE MOTOR REPLACEMENT (cont)						Tech Tip Number RK01-TT-2		
All	Processor Applicability					Author M. Doneski	Rev 0	Cross Reference
	8					Approval R. Boehm	Date 5/6/74	

9. Remove Motor Starting Capacitor. Note: THIS STEP NEED ONLY BE PERFORMED IF A NEW MOTOR (3600 RPM) WAS SHIPPED TO YOU.

NOW START REBUILDING THE DRIVE

10. Install new Motor Starting Capacitor (Ref. Step #9). Clamp capacitor, and replace both wires.
11. Install new Motor Mounting Plate, connect Tension Spring, and mount plate with three (3) screws.
12. Install new Drive Motor: land new motor in cavity. If it is a 3600 RPM Drive Motor, you may need "10-24" screws to mount it to the Mounting Plate. If it is a 1800 RPM Drive Motor, you will need "10-32" screws. Replace Ground Wire removed in Step #5.
13. Hook up the Motor Wires to the Terminal TB4:
 Yellow and White Wire - TB4-4
 Green and White Wire - TB4-3
 Red and White Wire - TB4-2
 Blue and White Wire - TB4-2
14. Install Motor Shaft Pulley. Note: If you have a new 3600 RPM Motor, you will need a new Pulley which is 1/2 the size of the pulley used with the 1800 RPM Motor.

Because of these changes, you will have to pay strict attention to the new Motor to find out if it is an 1800 RPM Motor or a 3600 RPM Motor and also check the pulley.

15. Install the new Drive Belt. Adjust it by moving the Motor Mounting Plate to get the proper tension.
 NOTE: THE BELT SHOULD BE FIRM BUT NOT TOO TIGHT.
16. Replace the Left Side Shroud.
17. Replace the drive in the cabinet.

CPL

digital	FIELD SERVICE TECHNICAL MANUAL				Option or Designator
	12 Bit <input checked="" type="checkbox"/>	16 Bit <input checked="" type="checkbox"/>	18 Bit <input type="checkbox"/>	36 Bit <input type="checkbox"/>	RK#5

Title +5 VOLT REGULATOR 5409503				Tech Tip Number RK#5-TT-1	
All	Processor Applicability			Author J. WALSH/A. MUIR Rev <i>0</i>	Cross Reference
	8	11		Approval HAROLD LONG Date 9/12/72	

The +5 volt regulator 5409503 which is used in both the RK#5 and RC11/RS64 has a partially installed ECO. For some reason, in a few units, some difficulty has been experienced which results in the triggering of the crowbar. If the crowbar triggers and system power is not removed the heat dissipated by the S.C.R. is sufficient to damage the regulator board. ECO 5409503-04 was written to correct this problem. However, due to material non-availability the ECO was never implemented fully. ECO 5409503-05 is a field retrofit to correct this deficiency. This ECO will be distributed immediately at the regional level and as soon as possible to all field offices.

CPL

Title IMPROPERLY WIRED SECTOR TRANSDUCERS				Tech Tip Number RK#5-TT-2	
All	Processor Applicability			Author J. WALSH/A. MUIR Rev <i>0</i>	Cross Reference
	8	11		Approval HAROLD LONG Date 9/12/72	

A number of improperly wired sector transducers were produced some time ago. We feel that our logistics system has been purged of these defective parts, however, as a precautionary measure, this tech tip is being issued. Below, both types of transducers are illustrated. Should replacement become necessary, it is suggested that a visual inspection be made. Improperly wired transducers should be disposed of and replacement ordered from Maynard or respective regional stockrooms.

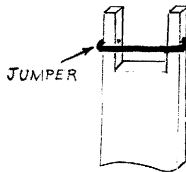

WRONG

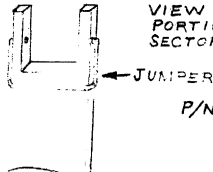

RIGHT

VIEW OF THE TOP
PORTION OF THE
SECTOR TRANSDUCER

P/N 30-10642

COMPANY CONFIDENTIAL

Title						RK05 MAINTENANCE MANUAL CORRECTIONS		Tech Tip Number		RK05-TT-3	
All		Processor Applicability				Author		J. WALSH/A. MUIR		Rev 0	
		8 11				Approval		HAROLD LONG		Date	
										Cross Reference	

RK05 MAINTENANCE MANUAL CORRECTIONS

Ch. 2 Sec. 2.1: Step 6 makes reference to 3 rubber shock-mount cushions. These shock mounts are presently not being employed. A restraint bracket is being developed and will be used when it is available. Presently there is nothing in this area to be removed.

Step 7 should state that the shipping bracket will be turned 180° rather than being completely removed.

Sec. 2.2 Step 4 - see correction to Sec 2.1 step 6.

Chapter 5, section 5:3.2.6 in Step 21 should be looking A7 A5M1.

section 5.3.3.3 in Step 4, pins A8M2 and A7M2 are called out for head selection. The should be B8M2 and B7M2 respectively.

Step 10 calls for a $\pm 10\%$ margin. This spec has been widened to $\pm 25\%$.

Section 5.3.4.3 Step 7 calls for 30 usec average. This spec has been changed to 70 usec + 10 usec average. Just as in the RK05, attempt to split the difference between upper and lower head when performing this adjustment.

Section 5.3.2.6 Step 22. The sweep speed should be 10 MS/DIV. Page 5- 14 figure 5-10 the sweep speed should be 10 MS/DIV.

CPL

Title						HEAD OSCILLATION PROBLEM		Tech Tip Number		RK05-TT-4	
All		Processor Applicability				Author		J. WALSH/A. MUIR		Rev 0	
		8 11				Approval		HAROLD LONG		Date 9/13/72	
										Cross Reference	

The composition of the duck bill used on the RK05 was changed. Should this new duck bill be installed on an early model RK05, a head oscillation problem may be encountered to correct this problem. See ECO H743-0001.

COMPANY CONFIDENTIAL

digital	FIELD SERVICE TECHNICAL MANUAL				Option or Designator
	12 Bit <input type="checkbox"/>	16 Bit <input checked="" type="checkbox"/>	18 Bit <input type="checkbox"/>	36 Bit <input type="checkbox"/>	RK05

Title RK05 POWER SUPPLY REMOVAL				Tech Tip Number RK05-TT-5	
All		Processor Applicability		Author J. Walsh/A. Muir Rev 0	
8	11			Approval H. Long Date 09/13/72	
				Cross Reference	

When removing the RK05 power supply and assembly some difficulty may be encountered. The reasons for this is the close tolerances between the power supply package, base plate assembly and chassis. To facilitate removal loosen the two (2) captive screws which hold the front most (+15 volt) regulator in place and remove it. There should now be enough room to maneuver the H742 supply free.

Title POSSIBLE MISCONNECTION OF NOISE CLIPPER				Tech Tip Number RK05-TT-6	
All		Processor Applicability		Author J. Walsh Rev 0	
8	11			Approval H. Long Date 1/4/73	
				Cross Reference	

An error in the DEC Pack Print RK05-0-1, chassis wiring, has resulted in a number of units being shipped to the field with the GE 130V MOV incorrectly connected.

The schematic has been corrected via ECO. To insure that drives which you are supporting have this MOV in correctly, make the following check:

- (1) Extend drive fully on sides
- (2) Remove the bottom panels
- (3) Look behind the spindle motor
- (4) If the red body of the GE MOV is parallel to the front panel, it is incorrectly connected
- (5) If the red body is parallel to the side panel, it is connected correctly.

The incorrect connection across the RK05 spindle motor starting relay is from terminal 3 to terminal 4. The connection should be from terminal 2 to terminal 4.

COMPANY CONFIDENTIAL

Title						RK11-C AC LOW DC LOW		Tech Tip Number		RK05-TT-7	
All		Processor Applicability				Author		Rev		Cross Reference	
8		111				Al Muir		0			
						Approval		Date			
						Jim Walsh		01/04/73			

Unibus AC LO and DC LO are separate signals peculiar to PDP-11 operation and are not to be confused with RK11C DR BUS AC LO and DC LO. These signals cannot be tied together, the result if this occurs, is PDP-11 power fail will not work.

A popular production wiring error is to connect these signals together at the power end panels. The correct wiring sequence is:

Unibus AC LO: From H720E at the bottom of the cabinet to AC LO connector on bottom power end plate.

Unibus DC LO: From H720E at the bottom of the cabinet to DC LO connector on bottom power end plate.

Disk Bus AC LO: From nearest H734 to AC LO connector top power end plate.

Disk Bus DC LO: From nearest H734 to DC LO connector top power end plate.

If the system has only RK05 disk drives there are no H734 supplies and therefore, no connections to the top end plate. These signals are then provided through the disk bus cable and RK11-C ECO #.00008 must be installed in the RK11-C logic.

Title						HEAD IDENTIFICATION		Tech Tip Number		RK05-TT-8	
All		Processor Applicability				Author		Rev		Cross Reference	
8		11				J. Walsh		0			
						Approval		Date			
						H. Long		01/04/73			

The RK05 head designations "up" and "down" are derived from IBM designations used in their moving head disk memories. When the air bearing is oriented upward, the term "up" is employed and when the air bearing is oriented downward, the term "down" is used. These designations are used throughout the moving-head disk industry.

Care should be exercised when encountering these terms, for the "up" head is the head which reads from the lower surface of the disk, i.e., the head which occupies the lower position in the carriage assembly. The "down" head is the head which reads from the upper surface of the disk, i.e., the head which occupies the upper position in the carriage assembly.

When ordering RK05 heads, use the following part numbers:

Upper head ("down" head)	30-10863-2
Lower head ("up" head)	30-10863-1

digital	FIELD SERVICE TECHNICAL MANUAL				Option or Designator RK05
	12 Bit <input checked="" type="checkbox"/>	16 Bit <input checked="" type="checkbox"/>	18 Bit <input type="checkbox"/>	36 Bit <input type="checkbox"/>	

Title HEAD IDENTIFICATION (Continued)				Tech Tip Number RK05-TT-8		
All	Processor Applicability			Author Jim Walsh	Rev A	Cross Reference
	8	11		Approval Harold Long	Date 06/04/73	

LOWER HEAD
30-10863-01

(Cable will plug into the physically upper set of pins on the G180, i.e. pins 5,6,7 & 8)

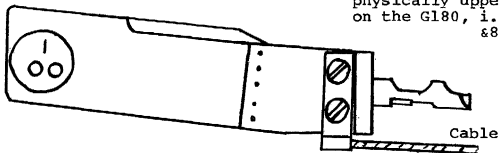

UPPER HEAD
30-10863-02

(Cable plugs to pins 1,2,3 & 4 on the G180)

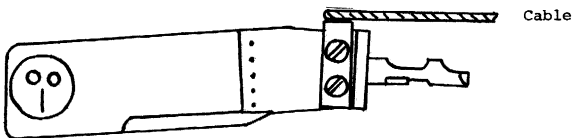

Note: No disk malfunction will occur if the head cables are reversed. (Indeed reversing them can be a useful troubleshooting aid) but any unit with reversed cables will produce discs that are not program compatible with other RK05 disk units, since the data is on the opposite side of the disk from where it is expected. Check for correct head wiring at installation time!

Title RK05 HEADS					Tech Tip Number RK05-TT-9	
All			Processor Applicability		Author Jim Walsh	
8 11					Rev 0	
Approval Harold Long					Date 01/04/73	
Cross Reference						

An ECO to the carriage assembly and one to the tailpiece of the R/W heads involved the machining of the flat surface where the head rests on the tang of the carriage. The new REV head will fit in the old REV carriage assemblies. Caution should be exercised however to insure that the pad of the head is on a plane which is parallel to that of the disk surface.

Heads on old REV tailpieces will not fit into new REV carriage assemblies.

New REV tailpieces can be identified by the machining marks on the shoulder. See Figure 1.

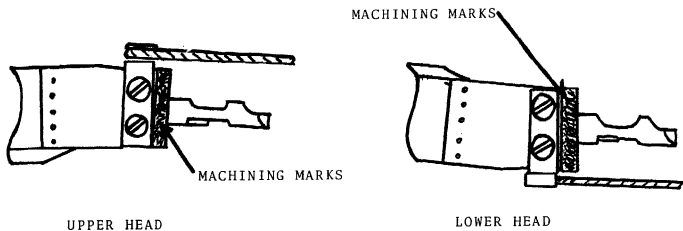

digital	FIELD SERVICE TECHNICAL MANUAL				Option or Designator
	12 Bit <input checked="" type="checkbox"/>	16 Bit <input checked="" type="checkbox"/>	18 Bit <input checked="" type="checkbox"/>	36 Bit <input type="checkbox"/>	RK05

Title Head/Disk Interference				Tech Tip Number RK05-TT-10	
All		Processor Applicability		Author W. Linton Rev	
8	11	15		Approval	
				Date 7/12/73	
				Cross Reference	

INTRODUCTION:

Head/Disc Interference, or HDI (frequently referred to as a head crash) is a result of head contact with a disc surface. Most commonly it is caused by a build up of dirt on the read/write head or a foreign particle in the air stream used as a "LUBRICANT" between the head and disc surface. If the problem is not **TOTALLY CORRECTED**, it has a propagation effect from drive to drive through pack after pack.

RECOGNITION:

Head /Disc Interference can be recognized by one or more of the following:

- A. Repetitive hard read errors. Because of adverse propagation effect, do not move any pack with this kind of error to more than one other drive. If errors persist, stop both drives and remove packs that are on them (DO NOT ALLOW USE OF THESE PACKS OR DRIVES UNTIL THE PROBLEM IS FULLY RESOLVED) investigate further for head/disc interference.
- B. Uncommon noise from the disc as characterized by audible tinkling sound. The noise will progress to a screech.
- C. Disc surface damage. A pack with any of the following conditions must be replaced:
 1. Deposits or smears that cannot be totally removed with alcohol and Kimwipes.
 2. A concentric scratch or any scratch where the aluminum substrate is visible. NOTE: The disc edge may have aluminum visible and cause no problem.

Title Head/Disk Interference						Tech Tip Number RK05-TT-10		
All	Processor Applicability					Author W. Linton Rev		Cross Reference
	8	11	19			Approval	Date 7/12/73	

RECOGNITION (continued)

3. Multiple adjacent concentric scratches regardless of length.
 4. Imbedded particle with trailing scratch (also called comet tail).
 5. Radial/diagonal scratches where aluminum substrate is exposed.
- D. Read/Write Head Damage
1. Dark brown or black streaks (burned oxide and/or aluminum) anywhere on the white ceramic head. clean the head. If the head again crashes on a known good, clean disk, replace the head.
 2. Discolored epoxy (normally white) at the R/W element which cannot be cleaned off with alcohol.
 3. Other. Bent or broken flexures can result from a prolonged HDI or mishandling. Replace any head with this type of damage. DO NOT ATTEMPT REPAIR. The ceramic head gimbal spring is adjusted to ± 1 degree landing attitude. If this attitude is disturbed in any way, the head will consistently crash when loaded on the disk.

RECOVERY:

- A. Inspect head and disc packs. Determine which heads and surfaces were involved in the crash. Check all heads and TOTAL pack library for possible spreading of a general crash problem.
- B. Replace all damaged heads and disc packs.
- C. Clean remaining heads.
 1. If contamination cannot be removed, the head must be replaced.
 2. Check head loading manually for correct operation.

digital	FIELD SERVICE TECHNICAL MANUAL				Option or Designator
	12 Bit <input checked="" type="checkbox"/>	16 Bit <input checked="" type="checkbox"/>	18 Bit <input checked="" type="checkbox"/>	36 Bit <input type="checkbox"/>	RK05

Title Head/Disk Interference				Tech Tip Number	RK05-TT-10
Processor Applicability			Author W. Linton	Rev	Cross Reference
All	8	11	15	Approval	

RECOVERY: (continued)

- D. Check absolute filter and disc pack filter for contamination. Replace it if necessary.
- E. Clean disc pack area watching particularly for filings, shaved metal, plastic particles, etc.
- F. In Steps F and G, the off line tester may be used. Mount a maintenance pack (not a CE pack) on the drive, turn power on and permit to come READY. Turn power off and check for oxide buildup on heads or other signs of head/disk interference. If satisfactory, turn power back on and run using the off line tester for at least 15 minutes. NOTE: heads being out of correct alignment will cause ERRORS. Try several different operations and correct any failure noted which cannot be ascertained to be due to incorrect head alignment.
- G. Mount a CE pack and check and align all heads.
- H. If original pack on which the crash occurred does not appear damaged, mount it. Turn on power and permit to come READY. Turn power off and check for signs of head/disc interference. If satisfactory, turn power back on and ensure that the pack is dumped before proceeding to the next operation.
- I. Check the pack and drive thoroughly using the disc pack diagnostics. It may be necessary to reformat the pack. Be sure to run Disk Data for at least 15 minutes.
- J. Inspect heads for oxide after 12 hours of run time. If oxide appears, determine cause and correct. If no oxide is visible recheck in a week.
- K. After one week, revert to PM schedule.
- L. Unless all damaged packs and all damaged heads have been removed from the machines involved and the actual cause of the HDI is determined (when possible) and corrected, the problem WILL reoccur in a short period of time. Usually within a month.

COMPANY CONFIDENTIAL

Title						Tech Tip		CPL	
Head/Disk Interference						Number		RK05-TT-10	
All		Processor Applicability				Author		W. Linton	
						Rev		0	
						Approval		Date	
								Cross Reference	

PREVENTION

- A. Proper cleaning of R/W heads.
- B. Insure air filtering system has no leaks and filters are clean, a dirty filter (drive filter) will cause contamination build up and excessive heating of the drive unit.
- C. Insure no foreign particles are being generated within a drive due to wear caused by interference between disk and cartridge or between sector slots and index/sector transducer.
- D. Careful handling of disc packs. Bumping of disc packs against cabinets or file drive front covers can bend the sector discs.
- E. Careful examination of head loading during PM periods.
- F. Disk packs should be stored in the computer room or similar environment. Cabinets that are clean and free of dust and made of metal or other fire resistant material are a good storage medium. Metal doors on such a cabinet will provide better protection.

REPORTING

- A. Fill out a Field Service Report and appropriate site equipment log, giving the following information:
 1. RK05 serial number.
 2. System type and customer name.
 3. Cause of damage (dropped pack, bent sector disc, HDI etc.)
 4. Was permanently stored customer information destroyed?
 5. Disc pack serial number and manufacturer.
 6. Cylinder and disc surface damaged.
 7. Location of R/W heads replaced (if any).
 8. Date of damage.

"Data Errors" could indicate abnormal conditions and should be investigated accordingly. To determine whether the data error can be circumvented, move the pack to another drive and try again. If the operation on the second drive is successful and data errors are not experienced, continue with normal operation. If data errors continue, follow this procedure:

CPL

digital	FIELD SERVICE TECHNICAL MANUAL				Option or Designator
	12 Bit <input checked="" type="checkbox"/>	16 Bit <input checked="" type="checkbox"/>	18 Bit <input checked="" type="checkbox"/>	36 Bit <input type="checkbox"/>	RK05

Title Head/Disk Interference				Tech Tip Number RK05-TT-10		
All	Processor Applicability			Author W. Linton	Rev	Cross Reference
	8	11	15	Approval	Date 7/12/73	

REPORTING: (continued)

NOTE: Successful recovery after trying on two drives is highly unlikely. Moving this suspect pack again and/or placing other packs on these suspect drives could cause a cascade of damage to other packs and drives since this type of repeating Data Error failure may be indicative of physical damage to the pack surface and/or drives.

Title DISK DESTRUCTION MADE SIMPLE				Tech Tip Number RK05-TT-11		
All	Processor Applicability			Author Mac Sloan/Bill Linton	Rev 0	Cross Reference RK05-TT-10
	8	11	15	Approval Jim Barclay	Date 8/2/73	

See attached picture. Yes, the head in an RK05 (or similar) disk drive actually "flies" closer than a finger print smudge or large smoke particle -- let alone a spec of dust, flake of dandruff or a hair. This may give you some idea why, when you can write your name in the dust on the outside of the disk cartridge, you may get disk oxide building up on the white ceramic head. Oxide build-up on the heads causes improper head flight and ERRORS if you're lucky-- CATASTROPHIC DESTRUCTION OF HEADS AND DISK if you're not. Keep the disk cartridge door shut and the disk in a clean bag or clean environment when not in the drive. And that's only dirt. There are other ways you can wreck a cartridge and/or drive; such as:

COMPANY CONFIDENTIAL

Title						Tech Tip	
DISK DESTRUCTION MADE SIMPLE						Number	
						RK05-TT-11	
All			Processor Applicability		Author		Rev
					Mac Sloan/Bill Linton		0
					Approval		Cross Reference
8			11		Jim Barclay		Date
15					8/2/73		RK05-TT-10

The small foil gimble spring which holds the white ceramic head to its support bracket is "tweaked" by the head manufacturer to ±1 degree so that the head will "land" properly on the boundary layer of air which spins along with the disk. Now, if you BEND the head in any way, you mess up this landing angle. When the head does not land right, usually one edge of the head "bites" through the air boundary layer and dings the oxide. Usually, the head will bounce and fly. Occasionally, however, known to us all, the head doesn't get up and fly -- it digs and burrows into the oxide, which happens to be moving at about 58 miles per hour.

The disk cartridge has other paths to glory. To my knowledge, no drive in the industry will accept a cartridge upside down. While this is a rather extreme case of an improperly seated cartridge, less obviously mis-seated cartridges will cause equally spectacular disk operation. DO NOT FORCE the cartridge into (or out of) the drive and, unless you are Westfield assembly or Field Service, do not "realign" the cartridge receiver.

Finally, dinged disks and oxide build up on heads are rather like a social disease which may be transmitted by either disk or heads to other heads or disks. Fix the problem before mixing bad cartridges or drives.

- S0: Disks, like jokes in the presence of ladies, should be kept clean.
 Do not bend heads!
 Do not rape the drive with the cartridge.
 Do not mix bad disks.

COMPANY CONFIDENTIAL

RK05

digital

FIELD SERVICE TECHNICAL MANUAL

Option or Designator

12 Bit 16 Bit 18 Bit 36 Bit

CPL

Title DISK DESTRUCTION MADE SIMPLE

Tech Tip Number RK05-TT-11

Processor Applicability

Author ANDY VEROSTIC Rev 0

Cross Reference

All 8 11 15

Approval JIM BARCLAY Date 8/2/73

RK05-TT-10

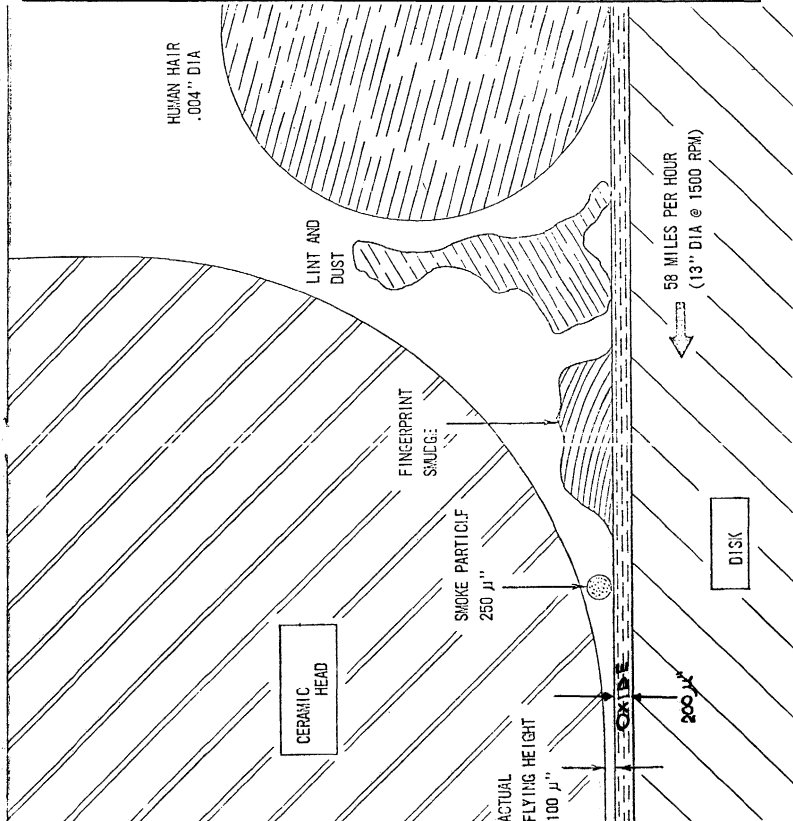

Title						INSTRUCTIONS FOR USING THE RK05K-AC ALIGNMENT CARTRIDGE						Tech Tip Number RK05-TT-12											
All						Processor Applicability						Author BILL LINTON Rev 0						Cross Reference					
8			11			15												Approval ART ZINS			Date 8/2/73		

CPL

The following information describes how to do an RK05 head alignment and Index/Sector timing adjustment using the DEC made alignment cartridge (RK05-AC). These instructions will be included in the next update of the RK05 Manual, which will be about three months from now.

1. ALIGNMENT CARTRIDGE

Function

The RK05K-AC Alignment Cartridge provides three tracks (track 105 plus spare tracks 85 and 125) of constant frequency data with alternating sectors recorded at displacements of +2.5 milliinches and -2.5 milliinches from the ideal track locations respectively.

When a head is aligned to specification, the readback signal shows equal amplitudes for all sectors (as shown when the oscilloscope displays only two sectors and triggered by the SECTOR SIGNAL). The degree of amplitude inequality in alternating sectors is indicative of the departure from exact alignment. See figures 3 thru 9.

Sector timing data is included on these three tracks to indicate the head gap location relative to sector pulse detection. This data is represented by a single pulse 70 u sec nominal following the INDEX pulse and 10 u sec prior to the onset of head alignment data.

An additional feature of the alignment cartridge is its ability to indicate the degree of runout of the spindle. By triggering the oscilloscope on INDEX and displaying a complete revolution of the disk on the display, the head may appear to be aligned at a few sector locations while misaligned at others. Such a condition is indicative of the degree of wobble of the spindle. Figure 1 shows a display with negligible runout while Figure 2 shows a spindle with considerable runout. The amount of wobble can be determined by the amplitude differences occurring in any adjacent pair of sector boundaries by the same equations as used for head alignment. The acceptance criteria for spindle runout is to be determined.

COMPANY CONFIDENTIAL

digital	FIELD SERVICE TECHNICAL MANUAL				CPL
	12 Bit <input checked="" type="checkbox"/>	16 Bit <input checked="" type="checkbox"/>	18 Bit <input checked="" type="checkbox"/>	36 Bit <input type="checkbox"/>	Option or Designator RK05
Title INSTRUCTIONS FOR USING THE RK05K-AC ALIGNMENT CARTRIDGE					Tech Tip Number RK05-TT-12
All	Processor Applicability	Author BILL LINTON	Rev 0	Cross Reference	
8	11	15	Approval ART ZINS	Date 8/2/73	

ALIGNMENT CARTRIDGE (continued)

Alignment Cartridge Specifications

Alignment and Sector Timing Tracks:

Primary Track - 105
Backup Tracks - 85, 125

Recorded Frequency: Nominal 720 KHz

No. of Sectors: 12

Alignment Accuracy, track 105: ± 200 u in.

Alignment Accuracy, tracks 85, 125: ± 300 u in.

Sector Timing: Single pulse 70usec ± 1 usec following INDEX pulse.

Figure 1
Negligible runout

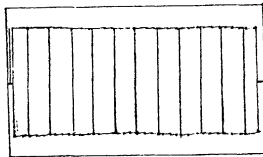
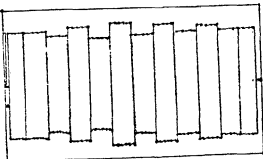

Figure 2
Considerable runout. NOTE: If this condition exists ensure that mating of spindle and disk are clean. Improper mating can cause such runout.



COMPANY CONFIDENTIAL

Title						INSTRUCTIONS FOR USING THE RK05K-AC		Tech Tip		Number		RK05-TT-12	
All						Processor Applicability		Author		Rev		Cross Reference	
8						11		15		BILL LINTON		0	
								Approval		Date			
								ART ZINS		8/2/73			

2. READ/WRITE HEAD CHECK AND ALIGNMENT

The following procedure describes the complete read/write head alignment. Before attempting this alignment procedure, ensure that the drive operates correctly and that the heads have not been contaminated by exposure to a defective cartridge. If new heads have been installed, it is recommended that this alignment procedure be performed off-line using backboard jumpers to move the positioner to the alignment cylinder. Off-line alignment is strongly recommended because of the ease of returning to the alignment cylinder whenever the positioner has been physically moved. However, simple maintenance routines or an RK05 Exerciser may also be used to move the positioner. See Step 9.

For a simple check of the head alignment, the appropriate on-line diagnostics may be used; however:

DO NOT ADJUST A HEAD THAT HAS LESS THAN 15% ERROR

REF STEP 11, THE FINAL ADJUSTMENT ERROR MUST NOT EXCEED 6%

To align or check the heads proceed as follows:

1. Unplug the drive AC line cord to remove power.
2. Disconnect the drive interface card from the electronic module and install an M930 terminator card in its place.
3. Reconnect the AC line cord to apply power to the drive and cycle the drive up to operating status.
4. Install an alignment cartridge on the spindle and operate the drive in the run mode for at least 30 minutes. This must be done to allow the alignment cartridge and the drive components to achieve thermal stabilization.
5. Using the WTPROT switch, place the drive in the write protect condition.
6. Set the oscilloscope controls as follows:

COMPANY CONFIDENTIAL

digital	FIELD SERVICE TECHNICAL MANUAL				CPL Option or Designator
	12 Bit <input checked="" type="checkbox"/>	16 Bit <input checked="" type="checkbox"/>	18 Bit <input checked="" type="checkbox"/>	36 Bit <input type="checkbox"/>	RK05

Title INSTRUCTIONS FOR USING THE RK05K-AC ALIGNMENT CARTRIDGE				Tech Tip Number RK05-TT-12	
All Processor Applicability			Author BILL LINTON	Rev 0	Cross Reference
8	11	15	Approval ART ZINS	Date 8/2/73	

2. READ/WRITE HEAD CHECK AND ALIGNMENT (continued)

vertical
mode = ADD (invert CHAN 2)
sensitivity = 20mV/div
coupling = dc

sweep
Asweep =
time = 500 us/div
trigger = normal

trigger
source = external*
coupling = ac
slope = (-) negative

* Use a 1:1 probe to connect the scope external trigger input to A02S2 (sector)

7. Connect the channel 1 probe to TP3 and the channel 2 probe to TP4 of the G180 card. (Use 10:1 probes).
8. Ensure that the positioner track scale indicates cylinder 00.

Figure 3

a. Error = -100%

Large misalignment. Head close to CYL 104. (Further misalignment only reduces signal on right of screen).

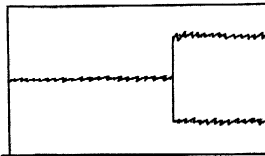

Title INSTRUCTIONS FOR USING THE RK05K-AC ALIGNMENT CARTRIDGE					Tech Tip Number RK05-TT-12	
Processor Applicability			Author BILL LINTON		Rev 0	
All			Approval ART ZINS		Date 8/2/73	
8	11	15			Cross Reference	

2. READ/WRITE HEAD CHECK AND ALIGNMENT (continued)

Figure 4

b. Error = -72%

Head considerably misaligned. Smaller left amplitude indicates head position less than CYL 105.

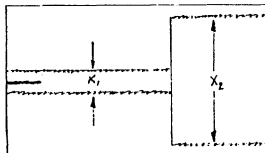

Figure 5

c. Error = -15%

Head slightly misaligned. Smaller left amplitude indicates head position less than CYL 105.

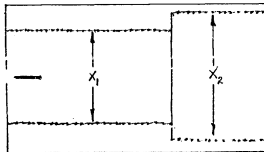
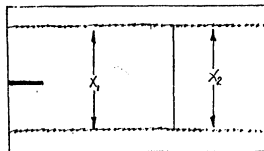

Figure 6

d. Right On

Head correctly aligned at CYL 105. Amplitudes are equal.



digital	FIELD SERVICE TECHNICAL MANUAL				Option or Designator
	12 Bit <input type="checkbox"/>	16 Bit <input type="checkbox"/>	18 Bit <input type="checkbox"/>	36 Bit <input type="checkbox"/>	RK05

Title				INSTRUCTIONS FOR USING THE RK05K-AC ALIGNMENT CARTRIDGE		Tech Tip Number		RK05-TT-12	
All				Processor Applicability		Author		BILL LINTON	
8				11		15		Rev 0	
Approval				ART ZINS		Date		8/2/73	
								Cross Reference	

2. READ/WRITE HEAD CHECK AND ALIGNMENT (continued)

Figure 7

e. Error = +15%

Head slightly misaligned. Larger left amplitude indicates head position more than CYL 105.

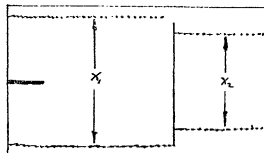

Figure 8

f. Error = +72%

Head considerably misaligned. Larger left amplitude indicates head position more than CYL 105.

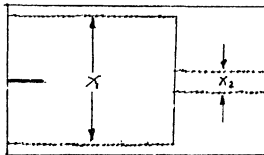
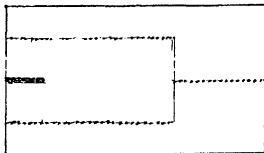

Figure 9

g. Error = +100%

Large misalignment. Head close to CYL 106. (Further misalignment only reduces amplitude of signal on left side of screen).



*To calculate % of error, use the following formula:

$$\% \text{ error} = \frac{X_1 - X_2}{X_1 + X_2} \times 100$$

Title					INSTRUCTIONS FOR USING THE RK05K-AC ALIGNMENT CARTRIDGE					Tech Tip Number RK05-TT-12		
All					Processor Applicability					Author BILL LINTON Rev 0		Cross Reference
8					11 15					Approval ART ZINS Date 8/2/73		

2. READ/WRITE HEAD CHECK AND ALIGNMENT (continued)

X_1, X_2 = amplitude and the resultant sign denotes the direction of error. A negative (-) sign indicates that the head is back too far.

9. Select cylinder 105 as follows:

NOTE: It is also possible to perform the following adjustments using the RK05 Exerciser or simple maintenance routines.

- a. Connect backboard jumpers from A07T1, A07C2, B07T1 or any available ground pins to the following points:

A08E1	CYL ADD 6 (64)
A08J1	CYL ADD 5 (32)
A08C1	CYL ADD 3 (8)
A08K1	CYL ADD 1 (1)

A04V1 SEL/RDY L

- b. Connect a jumper from B08H1 (STROBE) to B08N2 (SECTOR PULSE). The positioner should move to cylinder 105. Confirm this by observing the track scale indicator.
- c. If the RK11/RK05 is still cabled to the processor cylinder 105 may be selected by: (1) Load address 177412 (the RKDA) and deposit 006440₈ (CYL 105) then (2) Load address 177404 (RCC5) and deposit 000011 (Seek and Go).
- d. For RK8E/RK05, the following program may be used:

```

7000   BGN,   7201 /  CLA CLL
        6742 /  DCLR
        1212 /  TAD SEEK
        6746 /  DLDC
        7604 /  LAS (0-6 = cyl, 7 = surface)
        6743 /  DLAG
        6741 /  DSKP
        5206 /  JMP-1
        7402 /  HLT
        5200 /  JMP BGN
        SEEK, 3000 /  (Change bit 9 and 10 for drive other
                       than 0)

```

Load Address 7000
Set S.R. to 6440 (for cyl addr. 105₁₀ physically lower head)
 (or S.R. 6460 for physically upper head)
Press CLEAR, then CONTINUE

digital	FIELD SERVICE TECHNICAL MANUAL				Option or Designator
	12 Bit <input checked="" type="checkbox"/>	16 Bit <input checked="" type="checkbox"/>	18 Bit <input checked="" type="checkbox"/>	36 Bit <input type="checkbox"/>	RK05

Title	INSTRUCTIONS FOR USING THE RK05K-AC ALIGNMENT CARTRIDGE			Tech Tip Number	RK05-TT-12	
All	Processor Applicability			Author	Rev0	Cross Reference
	8	1	15	Approval	Date	
				ART ZINS		

10. Monitor the scope display for one of the waveforms illustrated in Figure 3 thru 9. Adjust the trigger level control so that the bright horizontal line appears at beginning of sectors displayed at left of screen. This indicates that these are odd sectors, while sectors displayed on right side of screen are even numbered sectors. The odd numbered sector amplitudes correspond to X_1 , and even numbered, X_2 in equation for % error. If none of the illustrated waveforms appear, the head is misaligned so badly that manual manipulation of the positioner is required. If manual manipulation is required, perform the following steps; if not, proceed to Step 11.
- a. Place Switch S1 (on H604) in the down or off position.
 - b. Slowly move the positioner by hand until the alignment pattern occurs. CAUTION: Do not use any undue force on positioner when manually changing track positions.
 - c. Since cylinder 85 and 125 have identical patterns, be sure that the displayed pattern is for cylinder 105.
 - d. Observe the track scale and note the cylinder indication when the "right on" waveform (Figure 6) is obtained. If the scale indicates less than 105, the head is too far forward in the carriage. Conversely, if the scale indicates more than 105, the head is back too far in the carriage.
 - e. Loosen the clamp and adjustment screws (Figure 10) and move the head in the appropriate direction until the "right on" waveform is obtained and the scale indication is slightly greater than 105.
 - f. Lightly tighten the clamp screw and turn on the positioner power (S1 up).
 - g. Turn the positioner power off, move the positioner fully forward and turn on the positioner power (S1 up) to initiate a restore (RTZ) operation. The positioner will automatically return to cylinder 105 following the RTZ.

COMPANY CONFIDENTIAL

Title						INSTRUCTIONS FOR USING THE RK05K-AC		Tech Tip		Number	
						ALIGNMENT CARTRIDGE				RK05-TT-12	
All		Processor Applicability				Author		Rev		Cross Reference	
						BILL LINTON		0			
8		11		15		Approval		Date			
						ART ZINS		8/2/73			

11. If one of the illustrated waveforms is present, note the direction in which the head must be moved to obtain the "right on" indication. If the head must be moved backward, loosen the head clamp and adjustment screws and gently push the head all the way back into the carriage. If the head must be moved forward, loosen only the clamp screw, then turn the adjustment screw until the correct waveform is obtained. (The adjustment screw is a vernier which only moves the head forward and should not be left torqued down after this adjustment).

NOTE

If the positioner is moved from cylinder 105 during the adjustment procedure, turn off positioner power (S1 down) and manually move the positioner fully forward then turn on positioner power (S1 up) to initiate a restore (RTZ) operation. The positioner will automatically return to cylinder 105 following the RTZ.

12. Ground B08M2 to select the upper head and repeat the preceding steps.
13. If available, use a torque wrench (C-IA9605893-0-0) and tighten the head clamp screw until the wrench begins to ratchet (55 oz/in.). If a torque wrench is not available, use the appropriate Allen wrench to tighten the head clamp screw snugly, however, do not over tighten.
14. Recheck to ensure that the clamping action did not disturb the head adjustment.

COMPANY CONFIDENTIAL

digital	FIELD SERVICE TECHNICAL MANUAL				Option or Designator
	12 Bit <input checked="" type="checkbox"/>	16 Bit <input checked="" type="checkbox"/>	18 Bit <input checked="" type="checkbox"/>	36 Bit <input type="checkbox"/>	RK05

Title				INSTRUCTIONS FOR USING THE RK05K-AC ALIGNMENT CARTRIDGE		Tech Tip Number		RK05-TT-12	
All				Processor Applicability		Author		Rev	
8				11		15		Approval	
				Author		BILL LINTON		Rev	
				Approval		ART ZINS		Date	
						Date		8/2/73	
								Cross Reference	

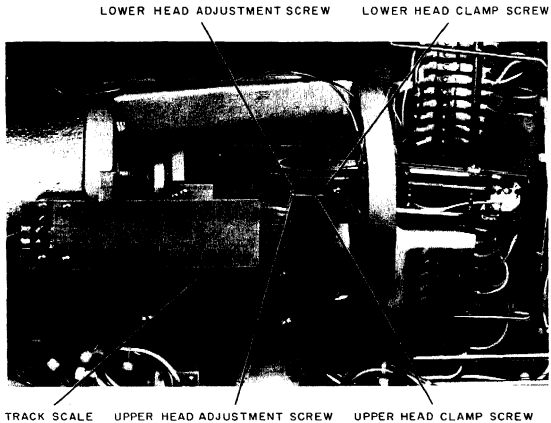

Figure 10
Read/Write Head Adjustments

Title INSTRUCTIONS FOR USING THE RK05K-AC ALIGNMENT CARTRIDGE					Tech Tip Number RK05-TT-12	
All			Processor Applicability		Author BILL LINTON	
					Rev 0	
8			11		15	
Approval ART ZINS					Date 8/2/73	
Cross Reference						

3. INDEX/SECTOR TIMING ADJUSTMENT

NOTE

Heads must be aligned to track before checking sector/index timing.

1. Unplug the drive AC line cord to remove power.
2. Disconnect the drive interface cable card from the electronic module and install an M930 terminator card in its place.
3. Reconnect the AC line cord to apply power to the drive and cycle the drive up to operating status.
4. Install an alignment cartridge on the spindle and operate the drive in the run mode for at least 30 minutes. This must be done to allow the alignment cartridge and the drive components to achieve thermal stabilization.
5. Using the WR PROT switch, place the drive in the write protect condition.
6. Set the oscilloscope controls as follows:

vertical

mode = ADD (invert CHAN 2)
sensitivity = 0.2V/div
coupling = dc

sweep

A sweep
time = 5 MS/dv
trigger = normal

trigger

source = external*
coupling = ac
slope = -

* Use a 1:1 probe to connect the scope external trigger input to A02R2 (INDEX).

COMPANY CONFIDENTIAL

digital		FIELD SERVICE TECHNICAL MANUAL				CPL Option or Designator
		12 Bit <input checked="" type="checkbox"/>	16 Bit <input checked="" type="checkbox"/>	18 Bit <input checked="" type="checkbox"/>	36 Bit <input type="checkbox"/>	RK05
Title INSTRUCTIONS FOR USING THE RK05K-AC ALIGNMENT CARTRIDGE					Tech Tip Number RK05-TT-12	
All	Processor Applicability				Author BILL INTON	Rev 0
	8	11	15		Approval ART ZINS	Date 8/2/73
						Cross Reference

3. INDEX/SECTOR TIMING ADJUSTMENT (continued)

7. Connect the channel 1 probe to TP3 and the channel 2 probe to TP4 of the G180 card. (Use 10:1 probes).
8. Ensure that the positioner track scale indicates cylinder 00.
9. Select cylinder 105 with jumpers as follows:

NOTE

It is also possible to perform the following adjustments using the RK05 Exerciser or simple test programs.

- a. Connect backboard jumpers from A07T1, A07C2, or any available ground pins to the following points.

A08E1	CYL ADD 6 (64)
A08J1	CYL ADD 5 (32)
A08C1	CYL ADD 3 (8)
A08K1	CYL ADD 0 (1)
A04V1	SEL/RDY L ¹⁰⁵
- b. Connect a jumper from B08H1 (STROBE) to B08N2 (SECTOR PULSE). The positioner should move to cylinder 105. Confirm this by observing the track scale indicator.
10. Monitor the scope for a single pulse followed by data beginning 10 us following the pulse.
11. Expand the sweep time to 10 us/div and check that the single pulse occurs 70 ± 10 us from the start of the sweep (figure 11).
12. Ground B08M2 to select the upper head and check for the same pulse tolerances as step 11. If necessary, adjust R6 on the M7700 card (card position 2) until the average time for the two pulses is 70 us and the 70 ± 10 us individual pulse requirement is maintained. If these requirements cannot be met, go to step 13 or 14.
DO NOT BEND THE HEADS!

Title						INSTRUCTIONS FOR USING THE RK05K-AC ALIGNMENT CARTRIDGE						Tech Tip Number		RK05-TT-12							
All						Processor Applicability						Author		Rev				Cross Reference			
8		11		15								Approval		ART ZINS		Date		8/2/73			

13. If R6 does not adjust the average of the two pulses to 70 usec, perform the following:
- Loosen the sector transducer screws.
 - If the average of the pulses is greater than 70 usec, move the transducer towards the airduct, if less than 70 usec move transducer away from the airduct.
 - Tighten the screws and perform steps 11 and 12.
14. If the time between the two pulses is greater than 20 usec, one or possibly both of the heads must be replaced. **DO NOT BEND THE HEADS.** The head to be replaced can only be found by trial and error.

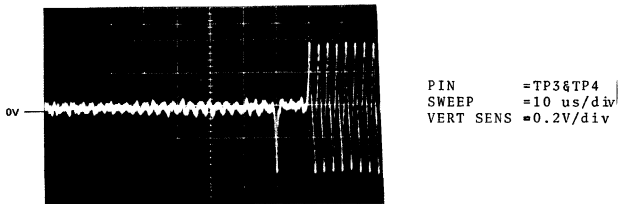

Figure 4 Index/Sector Waveform

COMPANY CONFIDENTIAL

digital	FIELD SERVICE TECHNICAL MANUAL				Option or Designator
	12 Bit <input checked="" type="checkbox"/>	16 Bit <input checked="" type="checkbox"/>	18 Bit <input checked="" type="checkbox"/>	36 Bit <input type="checkbox"/>	RK05

Title					ECO'S 36, 37, 39 and 41					Tech Tip				
					GENERAL INFORMATION					Number RK05-TT-13				
All		Processor Applicability			Author			BILL LINTON /A. VEROSTIC			Cross Reference			
8		11 15			Approval			ART ZINS			Date 8/15/73			

The purpose of this Tech Tip is to describe the Inter-relationship between RK05 ECO's 36, 37, 39 and 41.

These four ECO's will solve some of the cartridge seating problems that are being experienced with RK05's. Specifically they are:

1. Two tone cartridges that do not seat properly (difficult to insert or platter rubs on cartridge case).

ECO # 37 adds a new Duck Bill to fix this.

2. Cartridge door opener slips underneath the access door flap thus trapping the cartridge in the drive.

ECO # 36, by adding a rubber sleeve, raises the door opener so that now it should not slip under the flap.

3. Cartridge door opener slips off the access door so that the door tries to close when the cartridge is seated.

ECO # 39 causes the door opener to have greater tension against the door by adding two new springs to the door opener. Because of the new springs, ECO 41 adds a second rubber sleeve under the door opener to keep it from twisting.

Additional comments on the ECO's follow:

ECO # 36

1. No additional comments.

Title						Tech Tip	
ECO'S 36, 37, 39 and 41						Number	
GENERAL INFORMATION						RK05-TT-13	
All			Processor Applicability		Author		Cross Reference
			BILL LINTON		Rev		
8			11		0		
15			Approval		Date		
			ART ZINS		8/15/73		

Additional comments on the ECO's follow: (continued)

ECO # 37

1. The new duck bill installed by ECO # 37 can be recognized by the fact that the DEC part number and rev (12-10744 Rev C) is molded on the part. Therefore, you can easily recognize a drive that needs ECO # 37.
2. The addition of the new cartridge posts is for industry specification conformance. The new posts can be recognized by the fact that Rev "B" is stamped on them.
3. A new airduct and gasket are not to be installed and therefore, will not be shipped with the kit.
4. The following is the procedure for installing ECO # 37. It is included in this Tech Tip for your convenience, a copy will be sent with the ECO kit.
 - 4.1 Power down the RK05.
 - 4.2 Remove top and bottom covers.
 - 4.3 Install revision "B" cartridge support posts.
 - 4.4 Install Rev C duck bill.
 - 4.5 The cartridge receiver alignment procedure as printed in the Maintenance Manual stays in effect. The two types of cartridges presently in use (all white and two tone are also slightly different in height, i.e., the two tone one is generally lower than the all white ones. In some cases the cartridge receiver might be too tight to insert the all white cartridge. This of course has the effect that the cartridge gets compressed somewhat which reduces the internal clearance.

digital	FIELD SERVICE TECHNICAL MANUAL				CPI Option or Designator
	12 Bit <input checked="" type="checkbox"/>	16 Bit <input checked="" type="checkbox"/>	18 Bit <input checked="" type="checkbox"/>	36 Bit <input type="checkbox"/>	RK05

Title ECO'S 36, 37, 39 and 41 GENERAL INFORMATION					Tech Tip Number RK05-TT-13	
All Processor Applicability			Author BILL LINTON	Rev 0		Cross Reference
8	11	15	Approval ART ZINS	Date 8/15/73		

4.5 (continued)

If cartridge receiver is too tight, i.e., considerable force is needed to insert the cartridge bend it open so a white cartridge slides in easily (this is only to be used as an emergency procedure). Do not get disturbed by the fact that two tone cartridges have a lot of vertical play inside the cartridge receiver. After alignment of cartridge receiver, make absolutely sure there is about .010 to .040 inch clearance between the bottom of the cartridge and the two longitudinal rails of the cartridge receiver at a point close to the linear positioner (dimension "A" on page 5-36 of Maintenance Manual). Note the manual defines .020 to .040 inch. The cartridge, when resting inside the drive is suspended by three points: two support posts and the lower slot of the duckbill. The only purpose of the cartridge receiver is to guide the cartridge into position and to apply vertical pressure to the cartridge when it is seated. The cartridge receiver is not supposed to restrain the cartridge in any way. It has to give the cartridge freedom to assume the three point location, hence, clearance "A" is needed underneath the cartridge.

ECO # 39

1. When 39 is installed, ECO 41 must also be installed.

ECO # 41

1. If ECO 39 and 41 are installed there is no need to order ECO 36 since ECO 41 will be sent with two rubber sleeves DEC P/N 7411271, thus 41 incorporates ECO 36.

It is anticipated that the parts for these ECO's will be available by the first week in August.

COMPANY CONFIDENTIAL

Title ECO'S 36, 37, 39 and 41 GENERAL INFORMATION						Tech Tip Number RK05-TT-13		
Processor Applicability						Author BILL LINTON Rev 0		Cross Reference
All 8 11 15						Approval ART ZINS Date 8/15/73		

Please note that all four of these ECO's could be installed at the same time. Since there is no major disassembly or extensive parts installation required in any of these four ECO's, it is recommended that all four be installed at the same time. Alternatively ECO 36 or ECO 37 or ECO's 39 and 41 may be installed at separate times. Your choice is naturally going to depend on your particular situation.

If you have any further questions about this Tech Tip or the four ECO's, please call Bill Linton or Andy Verostic in Maynard at extensions 3242 or 2916.

Title LINEAR XDUCER GLASS SLIDE						Tech Tip Number RK05-TT-14		
Processor Applicability						Author ANDY VEROSTIC Rev 0		Cross Reference
All 8 11 15						Approval ART ZINS Date 9/27/73		

The glass slide attached to the carriage assembly is not field replaceable. This slide is aligned parallel to the motion of the carriage and requires a special fixture. If the slide becomes damaged or requires replacement, the whole positioner assembly should be replaced. The transducer block, however, is field replaceable. A procedure is in the Maintenance Manual.

digital	FIELD SERVICE TECHNICAL MANUAL				Option or Designator
	12 Bit <input checked="" type="checkbox"/>	16 Bit <input checked="" type="checkbox"/>	18 Bit <input checked="" type="checkbox"/>	36 Bit <input type="checkbox"/>	RK05

Title M7700 REV L					Tech Tip Number	RK05-TT-15			
All	Processor Applicability				Author	ANDY VEROSTIC	Rev	0	Cross Reference
	8	11	15		Approval	ART ZINS	Date	9/27/73	

M7700 Revision L and up can cause random data and seek errors if ECO # G180-00006 is not installed. It is important to check the G180 when replacing an old M7700 with one that is a revision L or later. A way to determine if the G180 ECO is installed is to check R58. Without the ECO R58 is 6.8K, with the ECO it is 3.3K.

Title					HEAD ALIGNMENTS		Tech Tip Number	RK05-TT-16	
All	Processor Applicability				Author	ANDY VEROSTIC	Rev	0	Cross Reference
	8	11	15		Approval	JIM BARCLAY	Date	10/24/73	

HEAD ALIGNMENT

Due to the number of complaints about head alignment and incompatibility, the following is an attempt to help clarify the situation.

Numerous head alignments have been necessary at installation time. This, it is felt, may have been due to improper tightening of the magnet housing bolts prior to shipment. This situation has been rectified by the use of torque wrenches in production on this assembly starting at serial number 7650. This does not mean that it is no longer necessary to check head alignment at installation. Head alignment should always be checked prior to running customer diagnostics and turning the system over to the customer.

COMPANY CONFIDENTIAL

Title HEAD ALIGNMENTS						Tech Tip Number RK05-TT-16		
All	Processor Applicability					Author ANDY VEROSTIC	Rev 0	Cross Reference
	8	11	19			Approval JIM BARCLAY	Date 10/24/73	

Another cause of numerous head alignments, especially repeat calls, is due to insufficient warm-up time. The CE pack must be run for 30 minutes in the drive being aligned prior to doing the alignment.

A common cause of incompatibility has been found to be incorrect Index/Sector Timing. Checking of this adjustment prior to head alignment may save you from having to do head alignments. This adjustment is done for the average of both heads to be 70 usec, with the maximum deviation ± 10 usec. Readings of 62 and 72 are not acceptable and should be adjusted to be 65 and 75 so the average is 70 and the ± 10 usec is still maintained.

ECO's 36, 37, 39 and 41 change mechanical assemblies within the drive and head alignment should be checked after they are installed. Be aware though, that doing head alignments may cause problems with reading customer packs and it may be necessary to back up customer packs before aligning heads.

The removal or loosening of the screws which hold the plenum cover (this houses the absolute filter) can change the stresses applied to the base casting which in turn can affect head alignment. Always check head alignment and Index/Sector Timing after the plenum cover is secured when changing the absolute filter. This means take your CE Pack with you at PM time if you plan to change the filter.

One final note, if you have any customers who generate disk packs to be used on other drives, they should be reminded of the need for proper temperature stabilization of the pack prior to generation.

Stabilization is spelled out in the Maintenance Manual (under section 2.3 of February 1973 edition) and should be pointed out to customers at installation time.

COMPANY CONFIDENTIAL

digital	FIELD SERVICE TECHNICAL MANUAL				Option or Designator
	12 Bit <input checked="" type="checkbox"/>	16 Bit <input checked="" type="checkbox"/>	18 Bit <input checked="" type="checkbox"/>	36 Bit <input type="checkbox"/>	RK05

Title READ DATA SEPARATOR ADJ. (G180)					Tech Tip Number RK05-TT-17		
All	Processor Applicability				Author ANDY VEROSTIC	Rev 0	Cross Reference
	8	11	15		Approval JIM BARCLAY	Date 10/31/73	

The data separator adjustment on the G180 as stated in the Maintenance Manual has proven to be on the low end of the acceptable range. The adjustment should be done on track zero with an all zero pattern prewritten on this track. R55 should be decreased to 440 NS, not 420 NS, as stated in Step 7. The above is for 16 or 12 bit machines. To use with 18 bit machines, where the packing density is higher, the setting is 390 NS. Tolerance on both settings is ± 10 NS.

Title RUSTY SPINDLES					Tech Tip Number RK05-TT-18		
All	Processor Applicability				Author ANDY VEROSTIC	Rev 0	Cross Reference
	8	11	15		Approval JIM BARCLAY	Date 10/31/73	

Some spindle assemblies have been found to be rusting. The rust can be removed by using Ship Mate Marine Polish # 626. Further rust build up can be prevented by coating the spindle assembly with Dow Corning Stopcock Grease after cleaning. New spindle assemblies will be plated to prevent this problem.

Title SPINDLE MOTOR PULLEY					Tech Tip Number RK05-TT-19		
All	Processor Applicability				Author ANDY VEROSTIC	Rev 0	Cross Reference
	8	11	15		Approval JIM BARCLAY	Date 12/10/73	

Some RK05's exhibit a problem with the spindle motor pulley rubbing on the bottom cover. The cause of this problem is an assembly process during which the shock mounts become permanently distorted to the point where the base casting is not supported high enough for the pulley to always clear the bottom cover.

There are a number of solutions to the problem, one of them is to replace all four shock mounts (PN 12-10843). However, since this is not an easy task for the average person, some alternate solutions are offered below.

1. If sufficient mounting space is available below the drive which exhibits the problem, it is possible to place a strip of foam or other material between the bottom cover and the chassis along the edge where the cover screws secure to the chassis. This should drop the bottom cover sufficiently to allow for free movement of the pulley. However, insure that all four sides of the cover still provide a sufficient seal to the unit after doing this.

2. Another solution is to raise the spindle motor by adding spacers between the motor and the base casting. Caution must be taken in using this method to insure that the belt still rides correctly on the pulley and will not work its way off after running for a period of time. Also, insure that raising the motor does not cause interference with the seating of the cartridge or any other part of the drive.

Title RK11-C ECO #8						Tech Tip Number RK05-TT-20	
Processor Applicability						Author ANDY VEROSTIC Rev 0	
All						Cross Reference	
11's						Approval BILL DIMBAT Date 1/24/74	
						RK05-TT-7	

Tech Tip RK05 #7 references ECO # RK11-C-00008. This ECO was coded non-field effective and therefore not distributed to the field.

When adding an RK05 onto an older RK11-C it may be necessary to install this ECO. The following is a summary of it along with a list of the ADD/DELETES.

PROBLEM: Proper operation of power fail on RK05 requires "DR BUS AC LO" and "DR BUS DC LO" on disk cable.

CORRECTION: Add "DR BUS AC LO" and "DR BUS DC LO" to disk cable.

ADD/DELETE SHEET

SIGNAL	FROM PIN	TO PIN	ADD	DELETE
DR BUS AC LO L	A08L1	B10F1	x	
DR BUS AC LO L	B10F1	B12F1	X	
DR BUS DC LO L	A08N1	B10F2	X	
DR BUS DC LO L	B10F2	B12F2	X	

Title G938 REV L MODULES STAMPED K						Tech Tip Number RK05-TT-21	
Processor Applicability						Author ANDY VEROSTIC Rev 0	
All						Cross Reference	
8 11 15						Approval JIM BARCLAY Date 5/14/74	

Some G938 Rev L modules are stamped Rev K. Revision L modules require readjustment of the servo signals. (A fault condition can occur when first installed prior to adjustment). The following table will aid in identification of correct revs.

	R28	R63	R77	L30	R65	R79
Rev K	3.83K	3.83K	6.81K	8.2K	8.2K	8.2K
Rev L	1.96K	1.96K	1.96K	75K	75K	75K

digital	FIELD SERVICE TECHNICAL MANUAL				Option or Designator
	12 Bit <input checked="" type="checkbox"/>	16 Bit <input checked="" type="checkbox"/>	18 Bit <input checked="" type="checkbox"/>	36 Bit <input type="checkbox"/>	RK05

Title RK05 SHOCK MOUNTS				Tech Tip Number RK05-TT-22	
All		Processor Applicability		Cross Reference	
11's	8's	15's		Author A. Verostic	Rev 0
				Approval G. Redpath	Date 3/28/74

Additional information regarding the shock mounts used on the RK05 has been discovered. The early belief that the spindle pulley rubbing on the bottom cover was caused by an assembly process has turned out to be a problem with certain shock mounts. Redish/Brown shock mounts can become permanently distorted when the shipping brackets are on for extended periods of time. These shocks are made of a soft rubber which may not return to it's original shape when the brackets are made of a harder rubber and will return to their original shape.

Replacement of shocks should be on an as needed basis and Redish/Brown ones in stock should be returned. Other solutions to this problem mentioned in TT-19 still apply.

Also check to see that the 3 bottom shipping brackets are removed. It is surprising how many times they are left on.

-- NOTES --

digital	FIELD SERVICE TECHNICAL MANUAL				Option or Designator
	12 Bit <input checked="" type="checkbox"/>	16 Bit <input type="checkbox"/>	18 Bit <input type="checkbox"/>	36 Bit <input type="checkbox"/>	RK08

Title					RK08 SECTOR TRANSDUCER ADJUSTMENT					Tech Tip Number		RK08-TT-1		
All 8's	Processor Applicability					Author		Schults/Herbener		Rev		0		Cross Reference
						Approval		Bill Cummins		Date		6/01/72		

The Pertec Manual, Chapter 6, Section B, does not say to remove the head alignment adapter before proceeding with the sector transducer alignment. DEC Maintenance Manual for RK8, Chapter 6.13.1, paragraph 4, carefully spells this out.

Disk systems set up inadvertently with the head adapter installed when doing sector transducer alignments will be incompatible with other systems.

Title					RK08 MAINDEC PROBLEM					Tech Tip Number		RK08-TT-2		
All 8's	Processor Applicability					Author		R. Boehm		Rev		0		Cross Reference
						Approval		W. Cummins		Date		06/21/72		

ECO #9 for the RK08 causes test 16 of the RK8 disk and control instruction test (Maindec-08-D5JB-D) to fail.

As a temporary fix change location 27~~8~~ to 232. There is an MCN to reflect this.

Title					PA/WD MODULE INCOMPATIBILITY					Tech Tip Number		RK08-TT-3		
All 8's	Processor Applicability					Author		Ralph Boehm		Rev		0		Cross Reference
						Approval		W. Cummins		Date		08/03/72		

The PA/WD module in the RK01 Drives made by CMD have 33K OHM resistors installed for R2 and R3. The same module made by PERTEC have 5.6K OHM resistors for R2 and R3. The PERTEC module will work in all RK01 drives. The CMD module, identified by the letters CMD etched on the module and the gold fingers, will only work in the CMD drives.

Pertec changed the resistor values because the early revision boards (CMD) would randomly generate spikes and cause errors. By changing the resistors R2 and R3 on the CMD PA/WD to 5.6K OHM the module will work in all RK01 drives. R2 and R3 are located between the two heat sinks.

Title						Cross Talk in CA Register		Tech Tip Number		RK08-TT-4	
All		Processor Applicability				Author		Robert Shelley		Rev 0	
8's						Approval		F. Purcell		Date 11/20/72	
						Cross Reference					

Occasionally the M206 modules used in the Current Address register (CA00-CA11) and Word Count register (WC00-WC11) do not ripple through properly when incremented (example: incrementing from 5777 to 6000). This is caused by cross-talk between jumper-lugs or etch runs on the M206. (Failure rate - once in 16 to 20 hours).

Replacing the M206's in RK08 B03, B04, B08 and B09 with M216's will correct this problem.

ECO #RK08-00012 reflects this change.

Title						2.88 MHz CRYSTAL AVAILABILITY		Tech Tip Number		RK08-TT-5	
All		Processor Applicability				Author		Chuck Sweeney		Rev B	
8's						Approval		Frank Purcell		Date 01/24/73	
						Cross Reference					

At present, all Crystal values between 1 to 10 MHz are classified under stock number 18-05501.

Unfortunately, the 2.88 MHz crystal used in the RK08 was never assigned a discrete number; such as 18-05501-XX.

This situation has since been corrected, and Field Service Stockroom in Maynard will carry the required crystal.

For reference, the parts needed on the M405 are as follows:

2.88MHz Crystal 18-05501-01
(Northern Engineering Labs, model NE-6A)

100 H VIH-100 Choke 16-00633

18MMF 100V capacitor 10-02608

NOTE: DEC currently stocks a 2.88 MHz Crystal under the number 18-10694-03. This crystal cannot be used in this application.

Title						Intermittent Faults		Tech Tip Number		RK08-TT-6	
All		Processor Applicability				Author		J. Stewart		Rev 0	
8		12				Approval		B. Kochman		Date 10/3/73	
						Cross Reference					

On the PA/WD board in the RK01 resistors are crimped or bent to prevent the resistor from sitting on the board after soldering. It is possible that rough handling will break these resistors, and cause faults, as has been seen on some system.

digital	FIELD SERVICE TECHNICAL MANUAL				Option or Designator
	12 Bit <input checked="" type="checkbox"/>	16 Bit <input type="checkbox"/>	18 Bit <input type="checkbox"/>	36 Bit <input type="checkbox"/>	RK8E thru Priority

Title Error in Manual				Tech Tip Number RK8E-TT#1		
All	Processor Applicability			Author Craig Showers	Rev 0	Cross Reference
	8	0	m	bu	Approval G. Chaisson	

At present there is an error in RK8E Manual (DEC-8E-HR3B-D). The problem exists in Table 2-2 or Priority Selection. Should read as follows:

Table 2-2

RK8-E Priority Selection

Priority	Install Jumpers
Priority 0 (highest)	W1 W4
Priority 1	W2 W3 W5

If you follow the manual the way it exists now and are running a system with one or more Break Devices you may end up having two devices jumpered for the same break priorities. An instant error condition is running DEC-X-8. The problem will be corrected in the manual with an addendum.

Title RK05 Disk Controllers				Tech Tip Number RK8E-TT#2		
All 8's	Processor Applicability			Author R. Boehm	Rev 0	Cross Reference
				Approval W.E. Cummins	Date 10/24/73	

There are two versions of the RK05 Disk Controllers for 8 family computers, the RK8e for the 8/e, 8M, 8F and the RK 8/F for the 8/I, 8L and 12. The RK8/F is used in the DW8/e option and uses different modules than the RK8/e.

M7104Yx - RK8F	M7104x - RK8/e
M7105Yx - RK8F	M7105x - RK8/e
M7106x - RK8F	M7106x - RK8/e

X = Particular revision for that module
 A M7104,5Y designated module will not work in a RK8/e neither will a M7104, 5 module work in a RK8F. The M7106 will work in either.

COMPANY CONFIDENTIAL

Title ROL 14 PROBLEM						Tech Tip Number ROL 14-TT-1				
All	Processor Applicability					Author	L. Goelz	Rev	0	Cross Reference
	14					Approval	G. Chaisson	Date	01/24/73	

Upon receiving and storing the contents of the PDP14 output register and filling ROL's storage buffer, ROL-14 would print out the contents of this buffer over and over again without stopping.

Patch Solution:

Below is a patch that will eliminate ROL-14's continual print out of its filled storage buffer.

LOCATION	FORMER INSTRUCTION	PATCH INSTRUCTION
7407	1051 TAD K30	7041 CIA
7410	7710 SPA CLA	1011 TAD INPTR
7411	5214 JMP OTRTNA	7650 SNA CLA
7412	1052 TAD ORBUFF	5371 JMP XECUTI
7413	3010 DCA OUTPTR	1010 TAD OUTPTR
7414	1010 TAD OUTPTR	1051 TAD K30
7415	7041 CIA	7710 SPA CLA
7416	1011 TAD INTPR	5221 JMP OTRTNE
7417	7650 SNA CLA	1052 TAD ORBUFF
7420	5371 JMP XECUTI	3010 DCA OUTPTR

/mt

COMPANY CONFIDENTIAL

PAGE 660	PAGE REVISION 0	PUBLICATION DATE January 1973
----------	-----------------	-------------------------------

digital	FIELD SERVICE TECHNICAL MANUAL				Option or Designator
	12 Bit <input type="checkbox"/>	16 Bit <input checked="" type="checkbox"/>	18 Bit <input checked="" type="checkbox"/>	36 Bit <input checked="" type="checkbox"/>	RP02

Title AMC AND INFOMAG HEAD IDENTIFICATION				Tech Tip Number RP02-TT-1	
All <input checked="" type="checkbox"/>	Processor Applicability		Author John Hyslop	Rev 0	Cross Reference
			Approval Bob Yurick	Date 6/1/72	

Infomag and AMC head arm assemblies are being shipped to the field as replacements for Memorex RP02 heads. The following chart and diagram should be used to cross reference and identify Memorex, AMC and Infomag part numbers.

Head cross reference chart: Find Memorex type in Column 1 and read across for Infomag or AMC replacement number.

Memorex Type No.	DEC Part No.	Infomag Part No.	DEC Part No.	AMC Part No.	DEC Part No.
Type A	29-14113	2202AD	29-19132	ERW313601-2	29-19670
Type B	29-14114	2203BU	29-19133	ERW313601-3	29-19671
Type C	29-14115	2201AU	29-19131	ERW313601-1	29-19669
Type D	29-14116	2204BD	29-19134	ERW313601-4	29-19672

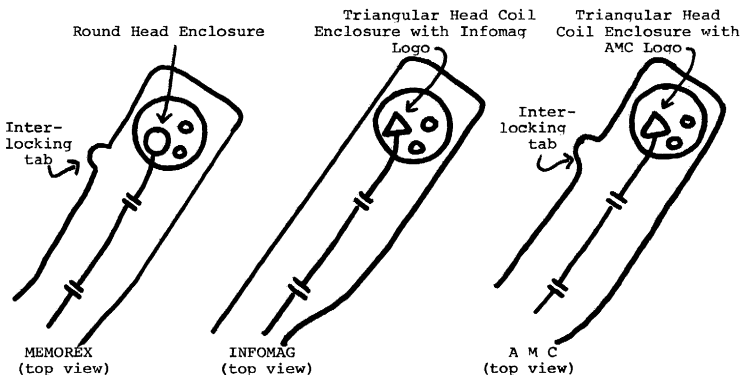

Title RP02 INFOMAG AND AMC REPLACEMENT HEADS						Tech Tip Number RP02-TT-2			
All X	Processor Applicability					Author John Hyslop		Rev 0	Cross Reference
						Approval Bob Yurick		Date 6/1/72	

Infomag and Applied Magnetics head assemblies are being shipped to the field as replacements for Memorex heads. The Infomag head assembly is slightly different mechanically and caution must be exercised if it is used as a surface 18 or 19 replacement.

Memorex and Applied Magnetics heads have a small tab on the side of the head arm (see illustration in Tech Tip RP02-TT-1.) This tab interlocks with the next higher head in the tee block and keeps the surface 19 head from hitting the shroud if the carriage is launched without a pack installed. The Infomag head does not have this tab. If an Infomag head is used in either surface 18 or 19 of an RP02 the surface 19 head must be removed before the carriage can be launched without a pack installed.

Launching a carriage without a pack on and spinning is not a normal procedure since it can cause damage to air bearing surfaces and head gimbels. This should only be done in cases such as cylinder transducer and carriage way alignments. A tool is being designed that will keep air bearing surfaces separated in these procedures. It will also solve the problem of the Infomag head in surfaces 18 and 19. This tool should be available to the field in about 4 weeks.

Title RP02 HEAD ALIGNMENT						Tech Tip Number RP02-TT-3			
All X	Processor Applicability					Author Lou Nay		Rev 0	Cross Reference
						Approval Bob Yurick		Date Sept. 14	

RP02-00046 (MEMOREX EC #1980) changes the head/arm clamps and screws but most significantly changes the torque specifications from 10 inch lbs to 6 inch lbs.

Check for this ECO on an unfamiliar drive before performing head alignment as the new type screws are designed not to bottom and therefore, could be stripped if too much torque is applied. The new type screws are a yellow/brown color and the clamp has a dull sand blasted finish.

digital	FIELD SERVICE TECHNICAL MANUAL				Option or Designator
	12 Bit <input type="checkbox"/>	16 Bit <input checked="" type="checkbox"/>	18 Bit <input checked="" type="checkbox"/>	36 Bit <input checked="" type="checkbox"/>	RP02

Title				NEW HEAD ALIGNMENT PROGRAM		Tech Tip Number		RP02-TT-4	
All	Processor Applicability				Author	ROGER PARTRIDGE	Rev	<input type="radio"/>	Cross Reference
	15	9			Approval	DICK EDWARDS	Date	9/26/72	

This program can be substituted for an off line tester when aligning heads.

Load the following program then follow the procedure in section 5.12.29 Alignment in 15 Tech Tip Manual.

200	LAW-1	777777
201	DPCA	706344
202	DPWC	706364
203	LAS	750004
204	DAC	040220
205	AND	500221
206	ALS	640705
207	XOR	240222
210	DPLA	706304
211	LAC	200220
212	AND	500223
213	XOR	240224
214	DPLF	706464
215	DPSE	706361
216	JMP.-1	600215
217	JMP	600203
220		000000
221		000037
222		222000
223		760000
224		011000

AC Switches 0, 1, and 2 select unit.

AC switches 13 thru 17 select head.

After aligning all heads select AC switch 4 to recall to 0 and back to 73₁₀. Then recheck all heads to be sure you weren't off cylinder.

Title				PART NUMBER FOR 150770 TRANSISTOR				Tech Tip Number		RP02-TT-5	
All X	Processor Applicability				Author	Lou Nay	Rev	0	Cross Reference		
					Approval	Lou Nay	Date	10-27-72			

The 150770 Transistors located on heat sinks 1,2 and 3 in place of the 2N5302 on newer drives has the part number 29-20169 assigned and is currently in stock.

Title RPO2 (MEMOREX) TRANSDUCER OSCILLATOR ADJUSTMENT										Tech Tip Number RP02-TT-6		
All Processor Applicability										Author J. Wentworth Rev 0		Cross Reference
10	11	15								Approval R. Edwards Date 1/17/73		

TRANSDUCER OSCILLATOR ADJUSTMENT

The adjustment of the transducer oscillator given in Tech Manual 5-12-11 is incorrect for tamp modules E.C. Level 487 and above.

The correct adjustment is as follows:

1. Set oscilloscope to 1V/Div, 2 us/Div.
2. Connect probe to Pin 16 of B06 (tamp).
3. Adjust R4 on B06 until output is equal to 7 us from leading edge to leading edge. The voltage level will be approximately 4 volts.

NOTE: With E.C. Level 487 and above, there will be only one pot on module.

Title RP02 Pack Grounding - Random Errors										Tech Tip Number RP02-TT-7		
All Processor Applicability										Author Ray Drueke Rev 0		Cross Reference
X										Approval Lou Nay Date 01/30/73		

Random errors on a Disk Pack Drive may be caused by poor pack grounding at the bottom of the spindle. The grounding contact should be checked for wear every six (6) months and replaced as necessary.

Required parts for an RP02 are:

29-19883 - Carbon button.

/mt

digital	FIELD SERVICE TECHNICAL MANUAL				Option or Designator
	12 Bit <input checked="" type="checkbox"/>	16 Bit <input checked="" type="checkbox"/>	18 Bit <input checked="" type="checkbox"/>	36 Bit <input checked="" type="checkbox"/>	RP02

Title					RP02/RP02S Cables		Tech Tip Number		RP02-TT-8		
All	Processor Applicability					Author	Dick Heckenberg		Rev	g	
	9	10	11	15		Approval	Burt Beyers		Date	02/13/73	
								Cross Reference			

Whenever experiencing flakey problems with your drives, check the bus input cable connector. Problems with this connector have shown up as read/write errors, inability to perform seeks, dropping ready, etc. The pins in the male portion sometimes push back into their receptacle when the drive or cable is vibrated or when the cable is installed.

To check for this condition, power down the drive and controller, remove the cable and push on the pins in the male connector with an eraser. If the pins push back, replace them! These pins are DEC Part Number 29-17688. Also a hardware kit is available which includes these pins, as well as most of the hardware necessary to maintain an RP02. These are stock number 29-13321 for Memorex and 29-17727 for ISS.

/mt

Title					RP02 NOISE AND RELATED FAILURES		Tech Tip Number		RP02-TT-9		
All	Processor Applicability					Author	Ray Drueke		Rev	0	
	9	10	11	15		Approval	Lou Nay		Date	02/14/73	
								Cross Reference			

Recently 6 RP02's on a -10 System showed an interesting problem. When any drive was exercised alone in Random seek mode no failures occurred. But it started failing when the next drive on the power buss started seeking. This was only apparent when the test (in this case, RD Pack) was run on both drives and the errors were soft with usually only 1 retry. However, a low soft error rate under normal monitor conditions (not running the test) had never been solved.

The problem was finally traced to noisey 2N3767 transistors in the Servo Drive Circuit of the Drive doing the seeks. There were 5V noise spikes on logic ground which were coupled over to the next drive's power supply through the power cables.

A well running RP02 should show no more than 2V of noise on Logic ground and should be able to complete 1 pass of random mode RD Pack, or its equivalent with no errors.

RDPack is a DECsystem -10 user mode rotating memory exerciser, originally sent to all regional support offices. It will also be included on the monitor distribution tape with the March release.

COMPANY CONFIDENTIAL

Title						FILE UNSAFE OR SEEK-INCOMPLETE-55V SHORT		Tech Tip Number		RP02-TT-10	
All		Processor Applicability				Author		Mike Flitterman		Rev g	
		9 10 11 15				Approval		Lou Nay		Date 5-2-73	
						Cross Reference					

Two incidents of the power supply cover plate being slightly bent and the upper lip shorting against the +55VDC on the transistor heat sink during seeks, have been reported. This causes multiple problems, ie; file unsafe or seek incomplete. Because the contact is only momentary, it does not blow the 55V fuse.

Insulating the lip of the plate with tape should prevent or solve the problem if it occurs.

Title						NEW CUSTOMER ENGINEERING DISK PACK		Tech Tip Number		RP02-TT-11	
All		Processor Applicability				Author		L.E. BALES		Rev A	
		9 10 11 15				Approval		Lou Nay		Date 6-13-73	
						Cross Reference					

1.0 GENERAL

1.1 Description

The CDC Eleven-High Engineering Disk Pack (D.E.C. Part no. 29-20658) is now available in the Field Service Stockroom. The pack is designed for use in maintenance and set-up procedures with RP02, RP02S and RP03 Disk Drives. The CE Disk Pack is identified by a yellow trimshield and contains the pre-recorded information used for head alignment and index sensor adjustment, and additional pre-recorded information for use as a maintenance aid.

1.2 Interchangeability and Compatibility

- 1.2.1 The "cateye pattern" recorded at cylinder 73/146 for RP02 and RP03 respectively is used to make the read/write head tracking adjustment. A similar "cateye pattern" is recorded on cylinder 20/40 (RP02 and RP03 respectively) for EMERGENCY USE ONLY if cylinder 73/146 becomes defective.
- 1.2.2 The information recorded at cylinder 118/236 for RP02 and RP03 respectively (index to burst time) is used to make the index sensor circumferential adjustment and head angle checks. Similar index to burst patterns are recorded at cylinders 03 and 201/06 and 402 (RP02 and RP03 respectively), and may be used to check carriage-way alignment.

COMPANY CONFIDENTIAL

digital	FIELD SERVICE TECHNICAL MANUAL				CPL Option or Designator
	12 Bit <input checked="" type="checkbox"/>	16 Bit <input checked="" type="checkbox"/>	18 Bit <input checked="" type="checkbox"/>	36 Bit <input checked="" type="checkbox"/>	RPO2

Title				NEW CUSTOMER ENGINEERING DISK PACK (cont.)		Tech Tip Number		RP02-TT-1	
All		Processor Applicability		Author		Rev		Cross Reference	
	9	10	11	15	L.E. Bales		A		
				Approval		Lou Nay		Date 6-13-73	

2.0 CYLINDER FORMAT

- 2.1 Cylinder 73/146 is made up of two concentric cylinders. The centers of the cylinders are spaced a nominal 0.0080 inch apart and the cylinders are written 0.0015 inch eccentric to the pack rotational center. Cylinder 73/146 is composed of a cylinder written 0.004 inch inboard from cylinder 73/146 and a cylinder written 0.004 inch outboard from cylinder 73/146. The two cylinders are written at different frequencies (inner cylinder 2.50 Mhz, outer cylinder 2.45 Mhz). At cylinder 73/146, the two frequencies beat together to yield a series of beat frequency nulls; that is, a series of "figure-eight". Cylinder 73/146 is written at a frequency nearly twice that of other commonly used frequencies to ensure that the clearest possible figure-eight pattern is achieved.
- 2.2 Cylinder 118/236. Surfaces 09 and 10 have a pulse written 3 usec. after the leading edge of the index pulse. Heads 09 and 10 are used at cylinder 118/236 to make the index sensor circumferential adjustment. All other surfaces of cylinder 118/236 have a pulse written 10 usec. after the leading edge of the index pulse. These surfaces are used to check the remaining heads in relation to heads 09 and 10 (head angle check). A burst timing of 10 usec. is used in order that a wider range of head variation (± 10 usec.) may be detected on a drive.
- 2.3 Cylinder 03 and 201/06 and 402
- Surfaces 09 and 10 of cylinder 03 and 201/06 and 402 have a pulse written 3 usec. after the leading edge of the index pulse. These two cylinders may be used to check carriage-way alignment by observing the difference in time from index pulse to the data pulse for the two cylinders.

COMPANY CONFIDENTIAL

TABLE 3-1

ADJUSTMENT OR CHECK

	<u>RP02</u>	<u>RP02S</u>	<u>RP03</u>
1. Read/Write head tracking: Cylinder 73 for RP02 Cylinder 146 for RP03	All crossovers + 2msec from center and all heads within + 1 msec of the average crossover point.		Refer to head adjustment procedure in vendor manual
2. Index Sensor: Surfaces 09 and 10 cyl 118 Surfaces 09 and 10 cyl 236	3 + 2 usec.	3 + 2 usec.	3 + 2 usec
3. Head Angle check: cylinder 118 for RP02 Cylinder 236 for RP03	Excluding heads 09 and 10, index leading edge to data pulse should be approximately 10 usec for "A" heads, and all A or B side heads should be within 10 usec of each other.		
4. Carriage-way Alignment Check: (refer to para 3.0)	5 + 1 usec	2.0 + 2.0 usec.	2.0 + 1.0 usec.

Title				NEW CUSTOMER ENGINEERING DISK PACK (cont)				Teach Tip Number RP02-TR-11	
All	9	10	11	12	13	14	15	Processor Applicability	
								Author I.E. Bales	
								Approval Lon Nay 4 Date 6-13-73	
								Rev A	
								Cross Reference	

CPI

digital	FIELD SERVICE TECHNICAL MANUAL				CPL Option or Designator
	12 Bit <input checked="" type="checkbox"/>	16 Bit <input checked="" type="checkbox"/>	18 Bit <input checked="" type="checkbox"/>	36 Bit <input checked="" type="checkbox"/>	RP02

Title	NEW CUSTOMER ENGINEERING DISK PACK (cont.)			Tech Tip Number	RP02-TT-11	
All	Processor Applicability		Author	L. E. Bales	Rev	A
	9	10	11	15	Approval	Lou Nay <i>h</i> Date 6-13-73
						Cross Reference

3.0 SPECIFICATIONS

Alignment specifications for RP02, RP02S and RP03 are listed in table 3-1. Use the following formulas in performing carriage-way alignment check:

RP02 (Memorex)

$$\frac{(\text{Hd09, Cyl201-Hd09, Cyl103}) + (\text{Hd10, Cyl201-Hd10, Cyl103})}{2} = \text{Alignment}$$

RP02S (ISS)

$$\frac{(\text{Hd09, Cyl-03 - Hd09, Cyl-201}) + (\text{Hd10, Cyl-03 - Hd10, Cyl-201})}{2} = \text{Align.}$$

RP03 (ISS)

$$\frac{(\text{Hd09, Cyl-06 - Hd09, Cyl-402}) + (\text{Hd10, Cyl-06 - Hd10, Cyl-402})}{2} = \text{Align.}$$

Where: HdXX, CylXXX equal the time from the leading edge of index pulse to the data pulse in usec.

4.0 CE PACK OPERATIONAL PROCEDURE

Before any alignment can be attempted, the temperature of the disk drive and disk pack must be stabilized. To stabilize a drive, it must be loaded and running for a minimum of one hour. To stabilize a disk pack that is at room temperature or warmer 15 minutes running time are required. INSURE THAT DISK DRIVE IS IN READ ONLY MODE.

- STEP 1: Align all heads (cylinder 73/146 RP02 and RP03 respectively) per specifications in Table 3-1. Refer to head alignment procedure in vendor manual.
- STEP 2: Check index sensor circumferential alignment and adjust if necessary. Refer to index sensor/transducer adjustment in vendor manual.
- STEP 3: Perform head angle check
- Use same Oscilloscope set-up as index circumferential alignment.
 - Seek to cylinder 118/236 (RP02 and RP03 respectively) and record the time from the leading edge of index pulse to the data pulse for each surface.

COMPANY CONFIDENTIAL

Title						NEW CUSTOMER ENGINEERING DISK PACK (cont.)		Tech Tip Number		RP02-TT-11					
All		Processor Applicability				Author		L.E. Bales		Rev		A		Cross Reference	
	9	10	11	15		Approval		Lou Nay		Date		6-13-73			

Step 3: (cont.)

- c. Take necessary corrective action to meet head angle specification listed in table 3-1. (i.e. replace head, check for proper seating of head arm in "T" block, etc.)
- d. If a head assembly is replaced or distributed, steps 1 and 2 must be repeated.

Perform step 4 if carriage way alignment is suspected.

STEP 4: Check carriage-way alignment.

- a. Use same Oscilloscope set-up as index circumferential alignment.
- b. Seek to cylinder 03/06 (RP02 and RP03 respectively) and record time from leading edge of index pulse to data pulse for surfaces 09 and 10.
- c. Repeat step 4b for cylinder 201/402 (RP02 and RP03 respectively).
- d. Calculate the carriage-way "Alignment" (refer to para 3.0) and compare with specification in table 3-1.
- e. If carriage-way alignment is not within specification (table 3-1), align carriage-way and repeat steps 1 and 2. (refer to Tech Tip 7.3.15 for RP02 (Memorex) carriage-way alignment. Instructions for RP02S/RP03 (ISS) carriage-way alignment are enclosed with carriage-way aligning tool (DEC part# 29-18118).

COMPANY CONFIDENTIAL

digital	FIELD SERVICE TECHNICAL MANUAL				Option or Designator
	12 Bit <input type="checkbox"/>	16 Bit <input checked="" type="checkbox"/>	18 Bit <input checked="" type="checkbox"/>	36 Bit <input checked="" type="checkbox"/>	RP02

Title					MODULE REVISION LEVELS		Tech Tip Number	RP02-TT-12
All	Processor Applicability				Author	L. E. BALES	Rev	0
	9	10	11	15	Approval	Lou Nay <i>ln</i>	Date	4-23-74
								Cross Reference

The following is a list of most current RP02 (MEMOREX) module revision levels.

<u>LOCATION</u>	<u>MEMOREX PN</u>	<u>EC LEVEL</u>
A02	1916	1359
A03	1941	1904
A04	1946	1005
*A05	1926	1113
A06	1901	1316
A07	2001	1005
A08	1921	1005
A09	2006	420
A10	2011	1128
B02	3236	1398
B03	1966	1005
*B04	1746	1225
B05	2111	1527
B06	1976	1289
B07	1931	1694
B08	1936	1854
B09	1936	1854
B10	1951	1031
*C01	1751	1311
C02	1911	1011
C03	1956	1527
C04	1971	1705
RD-WR AMPL (LEFT)	2016	1975
RD-WR-AMPL (RIGHT)	2021	1975

* MEMOREX PN's 3306, 3481, 3296 used in locations A05, B04, C01, respectively for 35ms access drives which can be identified by the model no. 660-LE on the "Red Tag" at the base of the unit. (Refer to RP02 TECH TIP 15)

Title					Possible Miswired or Misassembled Resistor Bracket Assembly on 714 (RP02) and 71S (RP03) Disk Drives		Tech Tip Number	RP02-TT-13
All X	Processor Applicability				Author	ISS Bulletin 35-1005	Rev	0
					Approval	John Hyslop	Date	2/27/74
								Cross Reference
								RP03-TT-13

This Tech Tip is issued for cross reference purposes.

PRINTED IN USA

Title										Tech Tip			
RP02 READ/WRITE ERRORS										Number RP02-TT-14			
All					Processor Applicability					Author Bill Buck/ Bob Packer		Rev 0	Cross Reference
X										Approval Lou Nay	Date 4-29-74		

A possible source of data errors is a broken ground wire connecting the carriage to the heads retracted switch. Even though the spiral shield still provides a ground connection for the carriage, data errors may occur.

The errors may occur only during periods of rapid carriage movement. The error may be present during the reading or writing of data but not both. Data pattern and transfer tests may run error free and if only writing of data is affected, positioner tests will run.

The ground assembly should be carefully inspected at each P.M. The broken wire may be difficult to detect, as it may retract into the shield.

If you have intermittent read/write errors that show up either on all "A" side heads or all "B" side heads, check for a loose ground connection on J17 (R/W deck plate left) or J21 (R/W deck plate right). Refer to figure below.

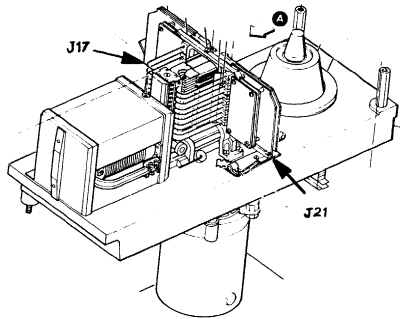

digital	FIELD SERVICE TECHNICAL MANUAL				Option or Designator
	12 Bit <input type="checkbox"/>	16 Bit <input checked="" type="checkbox"/>	18 Bit <input checked="" type="checkbox"/>	36 Bit <input checked="" type="checkbox"/>	RP02
Title FAST ACCESSED MEMOREX DRIVES (ENHANCED SERVO SYS)					Tech Tip Number RP02-TT-15
All	Processor Applicability		Author John Hyslop	Rev β	Cross Reference
X			Approval Lou Nay <i>LN</i>	Date 5-6-74	

This Tech Tip is copied from the "old" PDP10/6 Tech Tip manual.

There are now two types of Memorex RP02's in the field. There is the original 660-1A a 50Ms average access time drive and the new 600-1E a 35Ms average access time drive. The new 35Ms drive can be identified by the Model No. 660-1E on the "Red Tag" at the base of the unit. When working on Memorex drives be sure to identify the type of drive you have and use the documentation supplied with that drive for troubleshooting adjustment procedures and parts ordering. The major areas of difference in the two drives are: Certain parts are not interchangeable, they are:

	50Ms (660-1A)		35Ms (660-1E)	
	Vendor#	DEC #	Vendor#	DEC #
Velocity transducer*	200903	29-13264	201027	29-19281
R5 (on power supply door)	200827	29-16585	154600	29-19985
C3 (on power supply door)	200806	29-10168	150935	29-19986
CR8 (on power supply door)*	150855	29-17025	150855	29-17025
C15	(not used on 50Ms)		202353	29-19987
Diode	(not used on 50Ms)		157498	29-19988
Servo drive PCB C01	1751	29-10173	3296	29-18917
Servo control PCB B04	1746	29-10182	3481	29-18919
Addr and Spd Dcd A05	1926	29-10188	3306	29-18918

An addendum to the maintenance manual entitled Enhanced Servo Adjustment Procedures is supplied with the 35Ms drive. It must be used for the following adjustments:

- Cylinder transducer-to-Pawl setting time relationship check
- Cylinder transducer adjustment
- Detent Plunger Clearance
- Servo Power Supply Adjustments
- Servo Adjustment

The print set accompanying the 35Ms drive must be used for troubleshooting since there have been changes in printed circuit boards, power supplies and drive wiring.

*These parts are down-ward compatible (new part will work on old style drives). The new velocity transducer can be identified by a yellow dot on the plug.

NOTES

digital	FIELD SERVICE TECHNICAL MANUAL				Option or Designator
	12 Bit <input type="checkbox"/>	16 Bit <input checked="" type="checkbox"/>	18 Bit <input checked="" type="checkbox"/>	36 Bit <input checked="" type="checkbox"/>	RP02S

Title				TORSION ROD CHECK		Tech Tip Number		RP02S-TT-1	
All		Processor Applicability		Author		Rev		Cross Reference	
X				Roger Partridge		A			
				Approval		Date			
				Dick Edwards		11/16/72			

Physical damage to read/write heads has resulted from incorrect torsion rod positioning. This situation has occurred after unloading and then reloading torsion rods.

Whenever performing any maintenance on the read/write heads, where unloading/loading is necessary, make sure the torsion rods are all properly positioned by performing the following steps.

1. Move head load links up and down several times. There should be no binding.
2. Reload torsion rods and tighten head load latch holding screws.
3. Using a flashlight and a dental mirror head close to the head(s) (do not touch heads) examine the torsion rod for proper positioning. (See drawings below).
4. Torsion rods must not be out of position.
5. All torsion rod tips must be resting on load buttons.
6. All cam follower surfaces of the head assembly must move freely within the head load cam.

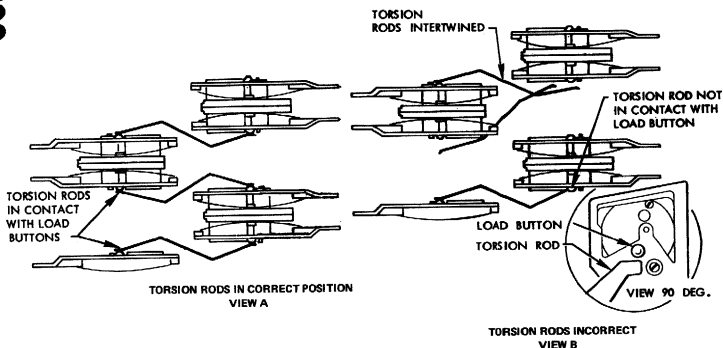

Title RP02S and RP03 Heads						Tech Tip Number RP02S-TT-2		
All Processor Applicability						Author Ray Drueke Rev 0		Cross Reference
X						Approval Lou Nay Date 10/17/72		

Recently, some heads were found to cause very intermittent errors because the signal cable was raised far enough off the Headarm to come into contact with the diskpack surface. Eventually the insulation wore away resulting in shorts.

The point in question is between where the cable exists the spring carrier and the first clamp on the Headarm.

Periodically check for this condition.

Title RP02S/RP03 Pack Grounding - Random Errors						Tech Tip Number RP02S-TT-3		
All Processor Applicability						Author Ray Drueke Rev 0		Cross Reference
X						Approval Lou Nay Date 10/17/72		

Random errors on a Disk Pack Drive may be caused by poor pack grounding at the bottom of the spindle. The grounding contact should be checked for wear every 6 months and replaced as necessary.

Required parts for RP02S and RP03 are:

29-17612 Spindle Contract
29-17613 Contact Retainer

Title New Head Alignment Program						Tech Tip Number RP02S-TT-4		
All Processor Applicability						Author R. Partridge Rev 0		Cross Reference
15 9						Approval Dick Edwards Date 10/31/72		

COMPANY CONFIDENTIAL

DIGITAL EQUIPMENT CORPORATION

digital	FIELD SERVICE TECHNICAL MANUAL				CPI Option or Designator
	12 Bit <input checked="" type="checkbox"/>	16 Bit <input checked="" type="checkbox"/>	18 Bit <input checked="" type="checkbox"/>	36 Bit <input checked="" type="checkbox"/>	RP02S

Title	DELETION OF TOP COVER INTERLOCK SWITCH ON 701, 714 and 715 DISK DRIVES (RP02S/RP03)			Tech Tip Number	RP02S-TT-5
All	Processor Applicability	Author John Hyslop	Rev	Cross Reference	
		Approval Lou Nay <i>LN</i>	Date 11-22-72		

The ITEL/ISS model RP02's and RP03 disk drives manufactured after August 14, 1972, no longer use a top cover interlock switch. ITEL/ISS Engineering has deleted this part. The switch is no longer available as a replacement part. Should this switch fail, remove and discard it. Tie the normally closed lead and the ground lead together to bypass the switch function.

Title	RP02/RP02S CABLES			Tech Tip Number	RP02S-TT-6
All	Processor Applicability	Author Dick Heckenberg	Rev 0	Cross Reference	
	9 10 11 15	Approval Burt Beyers	Date 02/13/73	RP02-TT-8	

Title	DATA ERRORS CAUSED BY INCORRECT DRIVE BELT INSTALLATION			Tech Tip Number	RP02S-TT-7
All	Processor Applicability	Author John Hyslop	Rev 0	Cross Reference	
		Approval Lou Nay <i>LN</i>	Date 03/30/73	RP03-TT-6	

Title	BRUSH RETRACT SWITCH ADJUSTMENT			Tech Tip Number	RP02S-TT-8
All	Processor Applicability	Author Ken Bouchard	Rev g	Cross Reference	
X		Approval Lou Nay <i>LN</i>	Date 5-1-73		

If the brush retract switch is out of adjustment, turning CB1 OFF then ON may prevent the drive from powering up using the switch on the front of the drive. Evidently, turning OFF CB1 causes the brush arm to move slightly, therefore, if the switch is not positioned to allow for some leeway the switch will open and the logic thinks the brush is in the pack and the drive won't power up. The switch should be positioned so a clearance of .02 to .03 inch exists between the switch body and actuating CAM.

COMPANY CONFIDENTIAL

Title NEW CUSTOMER ENGINEERING DISK PACK						Tech Tip Number RP02S-TT-9			
All Processor Applicability						Author L.E. Bales Rev g		Cross Reference	
9 10 11 15						Approval Lou Nay <i>LN</i> Date 6-13-73		RP02-TT-11	

The CDC Eleven-High engineering disk pack has, besides the usual head alignment and index sensor information, additional pre-recorded information for use as a maintenance aid.

Refer to RP02-TT-11 for use and specifications.

Title DEFECTIVE FORWARD STOP ON RP02S & RP03 Disk Drive						Tech Tip Number RP02S-TT-10			
All Processor Applicability						Author John Hyslop Rev g		Cross Reference	
9 10 11 15						Approval Lou Nay <i>LN</i> Date 7-18-73		RP03-TT-8	

The following information is from ISS/ITEL Field Engineering bulletin #35-0004:

The forward stop on all RP02S and RP03 disk drives should be inspected on the next P.M. for horizontal or vertical fractures. The fractures are caused by the mounting cap screw penetrating into the unthreaded portion of the hole. If the forward stop is fractured, replace the carriage assembly immediately to prevent HDI.

Title RP02S HEAD PART NUMBERS						Tech Tip Number RP02S-TT-11			
All Processor Applicability						Author Lou Nay Rev A		Cross Reference	
9 10 11 15						Approval Lou Nay <i>LN</i> Date 8-9-73			

There appears to be some confusion on part numbers for heads on the RP02S and RP03 drives. The correct numbers for RP02-S are:

<u>DRIVE</u>	<u>HEAD TYPE</u>	<u>VENDOR NUMBER</u>	<u>DEC NUMBER</u>
RP02S	AU	99000697-1	29-17647
(714)	AD	99000701-1	29-17648
	BU	99000705-1	29-17649
	BD	99000709-1	29-17650

and NO others.

COMPANY CONFIDENTIAL

CPL

digital	FIELD SERVICE TECHNICAL MANUAL				Option or Designator
	12 Bit <input type="checkbox"/>	16 Bit <input checked="" type="checkbox"/>	18 Bit <input checked="" type="checkbox"/>	36 Bit <input checked="" type="checkbox"/>	RP02S

Title MODULE REMOVAL					Tech Tip Number	RP02S-TT-12	
All	Processor Applicability				Author	Rev	Cross Reference
	9	10	11	15	L. E. Bales	g	
					Approval	Date	
					Lou Nay	9-1-73	

When removing or installing modules, caution should be exercised or damage to components on the module can result.

The AGC (SLOT A21) and Cylinder Detector (SLOT A20) modules are particularly vulnerable. The AGC module has components which are located near the back edge of the module. These components can be easily damaged if the grip type module extractor is used. Use only the extractor tool (DEC #29-17766) recommended by ISS. The paddle connector cable (SLOT A19) interferes with components located on the bottom of the cylinder detector module upon removal or insertion. To eliminate possible damage to components, hold the cable away from the cylinder detector module when removing or inserting.

Title					RP02S/RP03 INDICATOR BOARDS		Tech Tip Number	RP02S-TT-13
All	Processor Applicability				Author	Rev	Cross Reference	
	X				Ed Bruckert	g		
					Approval	Date		
					Lou Nay	3-11-74		

The following was a speed note in the old tech tip manual. A recent incident indicates the need for re-iteration.

Field Service has designed a plug-in module which displays fifty status bits, i.e., FILE UNSAFE, difference counter, head address register, and servo control signals. The board used LED's as indicators and is easily used.

1. Turn off logic power.
2. Open logic door, plug module into socket #10.
3. Apply logic power.

Future site spares will include this special module. All sites with I.S.S. disk pack drives can order it from the Field Service stockroom, P/N 29-19339. At a later date the module will have the number G973.

*****SPECIAL NOTE*****

Be sure the module you receive has the etch cut at pin 52. Since it was designed, a change was made to the drive which brings -48 volts to pin 52. If the test module is inserted without having cut this etch, considerable damage will be caused to the drive (smoke).

Title						REPLACEMENT, MATRIX PWA						Tech Tip Number RP02S-TT-14													
All		Processor Applicability						Author			L.E. Bales			Rev			j			Cross Reference					
x								Approval			Lou Nay			Date			4-18-74								

When replacing a Matrix PWA in an RP02S or RP03 insure that the revision level (dash number of vendor part number) of the replacement module is the same as the one being replaced. Use the following part numbers when ordering a Matrix PWA.

DEC PART #

29-17658

(use vendor part #)

VENDOR PART #

75000065-2

75000065-3

digital	FIELD SERVICE TECHNICAL MANUAL				Option or Designator
	12 Bit <input type="checkbox"/>	16 Bit <input checked="" type="checkbox"/>	18 Bit <input type="checkbox"/>	36 Bit <input checked="" type="checkbox"/>	RP03

Title INCORRECT REFRESHING OF RP03's BY 5.04 and 5.05 MONITORS				Tech Tip Number RP03-TT-1	
All X	Processor Applicability			Author Keith Coye	Rev 0
				Approval Lou Nay	Date 12/8/72
Cross Reference					

URGENT --- SITES WITH RP03's --- URGENT

The 5.04 and 5.05 Monitors have incorrect code in the RP03 Refresh routine in the once-only code. The monitor will type the following message: "DPAX is an RP03 drive, pack was written on RP02" and refuse to continue.

The problem has been evaluated by Software Support and a Monitor Change Order #3203 generated to fix the code.

Contact your local Software Support Office to schedule installation of this code. They are being notified in the large buffer of 9/25 of this fix.

Title RP03 INSTALLATIONS				Tech Tip Number RP03-TT-2	
All X	Processor Applicability			Author Mike Roney	Rev 0
	PDP 10			Approval Lou Nay	Date 12/8/72
Cross Reference					

In order to properly install RP03's it is necessary to install the following ECO's:

1. Installing RP03's mixed with Memorex RP02's:
RP02 ECO Number 54
2. Any RP03 Installation:
RP03 ECO Number 1

It is also advisable to place the RP03's as the first logical units if it is a mixed drive -10 system. This is due to the fact that the new diskpack reliability diagnostic (DARPC or DCRPC) has the unfortunate problem of using the first drive that is ready to base the maximum cylinder address that will be tested if running more than one drive at a time.

COMPANY CONFIDENTIAL

Title RP03 RANDOM READ ERRORS						Tech Tip Number RP03-TT-3		
All	Processor Applicability					Author John Hyslop	Rev 0	Cross Reference
	PDR 10					Approval Lou Nay	Date 12/12/72	

ISS has informed us that random read errors can occur on certain RP03 drives that contain a new style power driver, part #76000613-10 and a standard sum amp pulser, part #75003720-3. In drives that use the new power drivers, ISS has been selecting sum amp pulsers in final test. This means that sum amp pulser cards carrying a 75003720-3 part number may not be interchangeable in later model RP03's.

An ECO is in process to field retro-fit all drives with a new sum amp pulser carrying a 75003720-5 part number. This pulser will work reliably with the new power drivers. Parts and documentation should be available in 90 days.

As an interim solution, ISS has supplied us several tailor-made pulsers with a 75003720-4 part number. These are to be used as replacement parts in RP03's using the new power drivers. They are available only on a Pl basis from the Maynard stockroom. The standard sum amp pulser can still be used with the older style 76000613-8 power drivers.

Some later model drives have been shipped to the field with sum amp pulsers selected in test. If you have one of these drives and it is running reliably, leave it as it is until the ECO'ed pulsers are available. Do not order a 75003720-4 pulser as a standard office or site spare. These are tailor made boards and will be changed by a pending ECO.

Title PROPER WARM UP PERIOD FOR HEAD ALIGNMENT						Tech Tip Number RP03-TT-4		
All	Processor Applicability					Author Jim Kenworthy	Rev 0	Cross Reference
	11/ 43 10					Approval Lou Nay <i>LN</i>	Date 02/12/73	

The CE pack must be run on the drive to be tested at least 2 hours to achieve temperature stability before alignment is attempted.

Title RP03 ACCESS TRANSDUCER POSITION SIGNAL PHASE SHIFT						Tech Tip Number RP03-TT-5		
All	Processor Applicability					Author John Hyslop	Rev 0	Cross Reference
	11/ 43 10					Approval Lou Nay <i>LN</i>	Date 03/30/73	

The following information is from ISS/ITEL Field Engineering Bulletin #035-002.

Model 715 (RP03) Disk Drive Access Transducer position phase shift can be significantly reduced if the glass gratings are aligned between 0.002 and 0.003 inches. Change Access Transducer Adjustments Grating Proximity in all 715 Operation and Service manuals.

COMPANY CONFIDENTIAL

digital	FIELD SERVICE TECHNICAL MANUAL				Option or Designator
	12 Bit <input type="checkbox"/>	16 Bit <input checked="" type="checkbox"/>	18 Bit <input type="checkbox"/>	36 Bit <input checked="" type="checkbox"/>	RP03

Title DATA ERRORS CAUSED BY INCORRECT DRIVE BELT INSTALLATION				Tech Tip Number RP03-TT-6		
All	Processor Applicability			Author John Hyslop	Rev 0	Cross Reference
	11/45	10		Approval Lou Nay <i>L</i>	Date 03/30/73	

The following information is from ISS/ITEL Field Engineering Bulletin #035-003.

Drive Motor Belts which are installed with the smooth side out may cause soft read errors. During the next preventive maintenance check, verify that the drive motor belt is installed with the smooth side in. If the belt is incorrectly installed, remove the belt and clean pulley surfaces. Install a new belt with the smooth side in (e.g., smooth side against the pulley surface).

In addition, the plastic grommet on the motor plate should be checked to insure it is not binding. This can be done by turning the drive motor so as to loosen the belt. The motor and plastic grommet should go back into place easily.

Title NEW CUSTOMER ENGINEERING DISK PACK				Tech Tip Number RP03-TT-7		
All	Processor Applicability			Author L. E. Bales	Rev 0	Cross Reference
	11/45	10		Approval Lou Nay <i>L</i>	Date 6-13-73	

The CDC Eleven-High engineering disk pack has, besides the usual head alignment and index sensor information, additional pre-recorded information for use as a maintenance aid.

Refer to RP02-TT-11 for use and specifications.

Title DEFECTIVE FORWARD STOP ON RP02S & RP03 Disk Drive				Tech Tip Number RP03-TT-8		
All	Processor Applicability			Author John Hyslop	Rev 0	Cross Reference
	11/45	10		Approval Lou Nay <i>L</i>	Date 7-18-73	

The following information is from ISS/ITEL Field Engineering bulletin #35-0004:

The forward stop on all RP02's and RP03 disk drives should be inspected on the next P.M. for horizontal or vertical fractures. The fractures are caused by the mounting cap screw penetrating into the unthreaded portion of the hole. If the forward stop is fractured, replace the carriage assembly immediately to prevent HDI.

PAGE683	PAGE REVISION B	PUBLICATION DATE August 1973
---------	-----------------	------------------------------

Title RP03 HEAD PART NUMBERS						Tech Tip Number RP03-TT-9		
All	Processor Applicability					Author Lou Nay	Rev A	Cross Reference
	11/45	10				Approval Lou Nay <i>LN</i>	Date 4-18-74	

There appears to be some confusion on part numbers for heads on the RP02S and RP03 drives. The correct numbers for RP03 are:

DRIVE	HEAD TYPE	VENDOR NUMBER	DEC NUMBER
RP03	AU	99004027-1	29-19014
(715)	AD	99004026-1	29-19015
	BU	99004025-1	29-19016
	BD	99004024-1	29-19017

There are NO others

Title MODULE REMOVAL						Tech Tip Number RP03-TT-10		
All	Processor Applicability					Author L.E. BALES	Rev β	Cross Reference RP02S-TT-12
	11/45	10				Approval Lou Nay <i>LN</i>	Date 9-1-73	

Modules can be damaged if the wrong removal tool is used. Refer to RP02S-TT-12.

Title RP03 HEAD ALIGNMENT						Tech Tip Number RP03-TT-11		
All	Processor Applicability					Author J. Kelleher	Rev β	Cross Reference
	11/45	10				Approval Lou Nay <i>LN</i>	Date 9-1-73	

When aligning heads on a RP03, there are several things to remember:

- Jumper
A17 - 32 to A17 - 2
A6 - 1 to A6 -19
- The drive has to be warmed up with the IBM pack spinning for 2 hours minimum.
- Heads have to be positioned to cyl. 146₍₁₀₎ 222₍₈₎ for a minimum of 15 minutes prior to alignment.
- Scope inputs are:
Chn1 - A6 - 13
Chn2 - A5 - 1
- Trigger external positive on A6-14

Due to much tighter specifications on the RP03, head alignment is much more critical than on the RP02. The object is still the same. To get the left half of the cats eyes equal in length to the right half, but eyeing the scope for this is not accurate enough for the RP03, so the vendor has supplied a test point (A6-13) which makes alignment much easier to detect.

If head alignment is close but still out of alignment, there will be a pulse with a waterfall type effect. The object is to adjust the head to eliminate this on the trailing edge. Whether this crosses the center of the cats eye is irrelevant, the object is to get the cleanest trailing edge possible.

digital	FIELD SERVICE TECHNICAL MANUAL				Option or Designator
	12 Bit <input type="checkbox"/>	16 Bit <input checked="" type="checkbox"/>	18 Bit <input type="checkbox"/>	36 Bit <input checked="" type="checkbox"/>	RP03
Title Possible Miswired or Misassembled Resistor Bracket Assembly on 714 (RP02) and 71S (RP03) Disk Drives					Tech Tip Number RP03-TT-13
All X	Processor Applicability			Author ISS Bulletin 35-1005 Rev O	Cross Reference
				Approval John Hyslop Date 2/27/74	

From ISS Field Engineering Bulletin No. 35-0005:

The following problems have been encountered in drives in which the resistor bracket assembly (P/N 88000733-X) has either been miswired or contained resistors of the same value: seek incomplete; seek errors; or dropping ready. Should a drive exhibit these symptoms, verify that resistor R13 is 0.5 ohms and connected between PD1-7 and PD1-14, and resistor R14 is 0.8 ohms and connected between PD1-15, and inductor L2. If resistors R13 and R14 are wired in reverse, change the wiring to agree with above instructions. If resistors R13 and R14 are the same value (i.e., 0.5 ohms or 0.8 ohms), replace the resistor bracket assembly.

In addition to the above problems, the parts catalogs for 714 and 71S type drives depict R13 and R14 in the wrong position in the bracket assembly. Replace the Resistor Bracket Assembly figure in the parts catalog with the following figure.

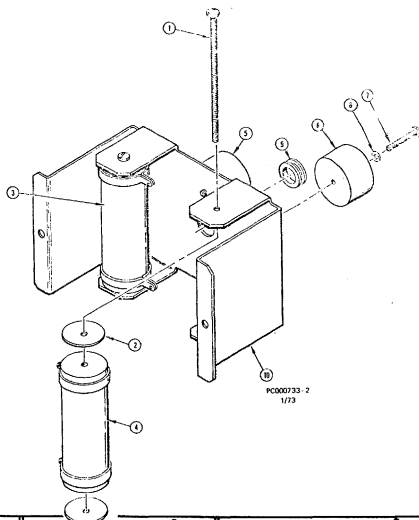

Title NOISE ON READ CABLE						Tech Tip Number RP03-TT-14		
All	Processor Applicability					Author R. Yurko	Rev g	Cross Reference
						Approval Lou Nay <i>LN</i> Date 9-19-73		

Two RP03's received in the field showed an identical problem. This problem showed itself as a failure to format properly the high cylinders and/or random read/write failures on the high cylinders. The problem has been traced to excessively long lead-in wires from pins five and six of socket five to the coaxial cable leading to the units buss, in both cases the black and yellow lead-in wires were in excess of five inches and seemed to allow cross-talk or noise into the read cable.

The vendor has been contacted and has set up procedures to catch this problem.

Title RP02S/RP03 INDICATOR BOARDS						Tech Tip Number RP03-TT-15		
All X	Processor Applicability					Author Ed Bruckert	Rev g	Cross Reference RP02S-TT-13
						Approval Lou Nay <i>LN</i> Date 4-11-74		

Before using an Indicator Board that you personally have not used before, make certain that the etch is cut going to pin 52 per RP02S-TT-13.

Title REPLACEMENT, MATRIX PWA						Tech Tip Number RP03-TT-16		
All X	Processor Applicability					Author L.E. Bales	Rev g	Cross Reference RP02S-TT-14
						Approval Lou Nay <i>LN</i> Date 4-18-74		

When replacing a Matrix PWA refer to RP02S-TT-14.

digital	FIELD SERVICE TECHNICAL MANUAL				Option or Designator
	12 Bit <input type="checkbox"/>	16 Bit <input checked="" type="checkbox"/>	18 Bit <input type="checkbox"/>	36 Bit <input checked="" type="checkbox"/>	RP04A

Title Tachometer Gain Adjustments					Tech Tip Number RP04A-TT-1	
All	Processor Applicability				Author Fred Larson	Rev 0
	10	11			Approval Chris Ball	Date 8/6/74
						Cross Reference ITEL Tech Tip #7

To maintain tachometer gain variations within limits, the glass position signals must be adjusted at the following time intervals:

1. When drive is installed,
2. One month after installation,
3. Four months after installation,
4. Ten months after installation,
5. One year intervals thereafter.

Title Header Compare and Format Errors					Tech Tip Number RP04A-TT-2	
All	Processor Applicability				Author Fred Larson	Rev 0
	10	11			Approval Chris Ball	Date 8/6/74
						Cross Reference

Presently any operation except read header and data or write check header and data will terminate immediately after (HCE) or (FER) is set. This does not allow for a header CRC comparison. Thus, if due to a read problem, we drop or pick the flag bit, we will set (FER) without (HCRC). Additionally, if we drop or pick a bit in the cylinder address or sector/track address words, we will set (HCE) without (HCRC). This may cause some confusion, as a common read problem may appear to be a positioner or DCL problem.

Title Power Driver and Filter Bracket Replacement					Tech Tip Number RP04A-TT-3	
All	Processor Applicability				Author Fred Larson	Rev 0
	10	11			Approval Chris Ball	Date 8/6/74
						Cross Reference ITEL TECH TIP #68

The EMA filter bracket assembly (29-21417) and the power driver assembly (29-21270) should always be replaced as a pair

Title Removing or Insertion of PCB's or Cables						Tech Tip RP04A- Number TT - #4		
All	Processor Applicability					Author Fred Larson	Rev 0	Cross Reference ITEL Tech Tip #58
	0	11				Approval Chris Ball	Date 8/6/74	

Allow at least 15 seconds discharge time after powering off the RP04 before attempting to remove or insert any PCB's or cables.

Title Data Bus Parity Errors						Tech Tip RP04A - Number TT - #5		
All	Processor Applicability					Author Fred Larson	Rev 0	Cross Reference -----
	10	1				Approval Chris Ball	Date 9/16/74	

A Class B error, such as HCE, disables Data Transfer but does not inhibit Sync Clk. If such an error occurs, bad parity will be set on the data bus by the RP04. The resultant error printout will indicate a data bus parity error as well as the original error. This affects the RH10 only. The RH11 is not affected due to its data bus buffering capabilities.

Title Dual Controller Testing						Tech Tip RP04A Number TT - #6		
All	Processor Applicability					Author Fred Larson	Rev 0	Cross Reference -----
	10	11				Approval Chris Ball	Date 9/16/74	

Presently RP04's leaving Westfield as single controller machines are not being tested in their dual controller configuration. Be aware that all dual controller logic has not been tested and that this untested logic may be the source of any problems that arise during the field installation of this feature.

This omission has been corrected and any RP04 leaving Westfield after October 15, 1974, will be fully tested.

Title Switch Function Title Change						Tech Tip RP04A Number TT - #7		
All	Processor Applicability					Author F. Larson	Rev 0	Cross Reference -----
	10	11				Approval Chris Ball	Date 9/16/74	

A Phase-In ECO has been released by ISS which changes the switch function title "Port Lock" to "Controller Select." This is a title change only and does not alter the function of the switch.

Title LOOK-AHEAD REGISTER FAILURE						Tech Tip RP04A Number TT - #8		
All	Processor Applicability					Author Fred Larson	Rev 0	Cross Reference
	10					Approval Chris Ball	Date 9/16/74	

Test "Secnt" in MD-10-DCRPF may fail when running with a 16-bit formatted pack. The resulting error printout indicates that the extension field of the look-ahead register has been reset. This is due to the extension counter being reloaded to 0 at count 608₁₀ instead of 610₁₀. This problem PAGE 688 should not affect customer operation and will be corrected with a phase-in ECO.

digital	FIELD SERVICE TECHNICAL MANUAL				Option or Designator
	12 Bit <input checked="" type="checkbox"/>	16 Bit <input type="checkbox"/>	18 Bit <input type="checkbox"/>	36 Bit <input type="checkbox"/>	RS08

Title	HARDWARE PROBLEMS EXISTING WITH RF08 AND RS08				Tech Tip Number	RS08-TT-1
All	Processor Applicability		Author	C. Cline	Rev	0
			Approval	W. Cummins	Date	7-31-72
						Cross Reference RF08-TT-2

Title	OHM METER TESTING OF DISK HEADS IN RF/RS08-DF32				Tech Tip Number	RS08-TT-2
All	Processor Applicability		Author	W. Freeman	Rev	0
			Approval	W. Cummins	Date	7-31-72
						Cross Reference DF32-TT-7

Title	RS08-TA TRACK WRITER PROBLEM				Tech Tip Number	RS08-TT-3
All	Processor Applicability		Author	B. Freeman	Rev	0
	8I		Approval	W. Cummins	Date	7-31-72
						Cross Reference

A problem has been encountered in the use of the RS08-TA Timing Track Writer. If, after the timing tracks have been recorded, errors indicating a parity error are encountered when running the Disk Data Maindec, the Track A pulses may have been recorded improperly. This can be verified by syncing on a failing address and checking pin B09D in the RS08. If the thirteenth pulse occurs within a shorter time interval than the other twelve, the timing track writer has written the track improperly. The problem can be remedied by re-routing wires in the RS08-TA. The wires on the output of the Track C writers must be moved away from those on the Track A writers. The wires on A21K thru A21R, and B21K thru B21R should be moved away from the wires which run from the logic blocks to the metal plate on which the switches are mounted.

Title	RS08 CLEANING KITS FOR DMI SURFACES				Tech Tip Number	RS08-TT-4
All	Processor Applicability		Author	C. Cline	Rev	0
	8I		Approval	W. Cummins	Date	7-31-72
						Cross Reference

DMI cleaning kits are now available to the field. Each RS08 kit (suitcase) should contain two DMI cleaning kits along with its present complement of paraphernalia. Each time a DMI disk is cleaned discard the used DMI kit completely and order a new one.

COMPANY CONFIDENTIAL

Title RS08 CLEANING PROCEDURE FOR DMI SURFACES						Tech Tip Number RS08-TT-5	
All		Processor Applicability		Author C. Cline		Rev	Cross Reference
8I						Approval W. Cummins	Date 7-31-72

In future RS08 disk units there will be two kinds of surfaces used. One will be the original Techmet surface which is silver and highly polished. The second is a new surface, DMI, generally a dark blue and/or yellowish color. Variations in color and spots need not be of concern.

With the phasing in of a new disk, an entirely new cleaning procedure was developed. Its purpose is to resist corrosion and lubricate the surface. Each disk kit (suitcase) will be supplied with enough DEC cleaning fluid and lint free towels to clean one DMI surface.

NOTE: This cleaning fluid is to be used only on the DMI surfaces, continue using current procedure on Techmet surface.

The DMI cleaning procedure is as follows:

1. Use special DEC cleaning only on DMI disks.
2. Mount the disk on a spin stand. Apply DEC cleaner to a clean lab towel and wipe the surface of the disk. Use the clean side of the towel to wipe the disk surface dry.
3. Apply DEC cleaner on disk surface. Let a thin layer of the solution stand on the disk surface.
4. After the solvent completely evaporates, take another clean lab towel and start buffing the surface, using clean sides of the towels after every few strokes.
5. Continue buffing using new towels whenever necessary until there is no dark spot or stain on the disk surface.
6. Wipe the edges of the disk. The disk is now ready to be mounted on the hub.
7. After mounting the disk, slowly turn it by hand.
8. If it feels hard to turn, remove the disk and rebuff with dry towels. If the disk is properly buffed, the heads will not stick to the disk.
9. Reassembly of the disk is exactly as before.

NOTE: If the disk surface has not been buffed satisfactorily the excess DEC cleaner can get collected on the Ferrite pads. When reassembling the disk units the heads must be cleaned and examined in the usual manner.

COMPANY CONFIDENTIAL

digital	FIELD SERVICE TECHNICAL MANUAL				Option or Designator
	12 Bit <input checked="" type="checkbox"/>	16 Bit <input type="checkbox"/>	18 Bit <input type="checkbox"/>	36 Bit <input type="checkbox"/>	RS08 to RS08TA

Title SENSITIVE TIMING TRACK CABLES				Tech Tip Number RS08-TT-6	
All	Processor Applicability			Author O. Josbacher	Rev 0
X				Approval H. Long	Date 09/20/72
					Cross Reference

Most timing track cables are sensitive to pressure or sharp bends. This shows up by securing the cable by hand or bending the cable while the disk is being exercised, "Hardware Errors" will result. Such errors are only of momentary nature and occur at the instant the pressure is applied. There is no after effect and this phenomenon is not observed under normal operating conditions.

/mt

Title LEAKS AROUND ABSOLUTE FILTERS				Tech Tip Number RS08-TT-7	
All	Processor Applicability			Author J. Kilkenney	Rev 0
X				Approval W. Cummins	Date 09/20/72
					Cross Reference

When replacing the absolute filter, check to see that the rubber strip at the top of the filter makes a good seal with the filter top cover.

If it does not, remove the rubber strips from the old filter and replace in the bottom of the filter holder, so that the new filter will be higher in the filter holder and so provide a good air tight seal.

/mt

COMPANY CONFIDENTIAL

Title Fan Kit for RS08-TA						Tech Tip Number RS08TA-TM-1				
All 8	Processor Applicability					Author	Ron Pelletier	Rev	0	Cross Reference
						Approval	Ray Turcotte	Date	6/11/74	

The Fan Kit is an option offered by DEC for all RS08-TA. It's purpose is to prevent over heating of the logic, over prolonged periods of use. The kit can be ordered under the following number: 7010023-00.

The kit consists of the following items:

1	Fan				12-10719
1	Bracket				74-11989
1	Power Cord				17-00015-6
2	Phillips Head Screws	6-32	x	3/8 lg	90-06037-02
2	Kep nuts	6-32			90-08185
2	Flat Ph. Hd. Screws	8-32	x	3/8 lg	90-06022-01

Cost of the Kits is \$9.00.

For Further information, contact Ron Pelletier, Maynard, EXT. 6102.

digital	FIELD SERVICE TECHNICAL MANUAL				Option or Designator
	12 Bit <input checked="" type="checkbox"/>	16 Bit <input type="checkbox"/>	18 Bit <input type="checkbox"/>	36 Bit <input type="checkbox"/>	SOFTWARE

Title BOMBING OF RIM ON TAPE READ				Tech Tip Software TT#1 Number		
All	Processor Applicability			Author Bob Nunley	Rev 0	Cross Reference
	8	8S	8E	8I	8L	

When using RIM and starting to read the tape before leader/trailer code, hole 8, it is possible to bomb a location of RIM loader and result in an incorrect load or halting the load by putting RIM into a loop. The problem may look like a hardware error, but is actually proper operation of RIM.

When RIM is first toggled into memory, there is some number in 7776 possibly in the area of RIM: or if RIM is in memory and a tape has been read to the end, at the end of tape some number is deposited in 7776 - this happens most with the high speed reader. When the new tape to be read is started before the leader-trailer, the 0000 word read is treated as data and is stored indirectly from location 7776. This happens because RIM, looking for hole 8, (leader-trailer) or hole 7 (address identifier) seeing neither, does the skip at 7764 (SPA-no hole 8) but not the skip at 7772 (SNL-no hole 7) and the instruction in 7773 is DCA-I-7776, therefore, some location gets zeroed. This does not happen with BIN because the location which contains the destination address is set to zero during the first two characters read and incremented until hole 7 is encountered, then set to the correct address to be loaded.

These are cures:

- 1) Insure the read starts on hole 8.
- 2) Set 7776 = 0000 before beginning the read.

Title 8I/8L INSTRUCTION LIST ERROR				Tech Tip Software TT-2 Number		
All	Processor Applicability			Author Chuck Sweeney	Rev 0	Cross Reference
	8I	8L		Approval Bill Cummins	Date 7-31-72	

There is an error in the High Speed Rim Loader listing on the 8I/8L instruction card; location 7765 should contain 5374, not 5357. Although many Rim format tapes will load properly, Checkerboard High will not.

COMPANY CONFIDENTIAL

Title PDP-12 PROGRAMS						Tech Tip Software-TT-3 Number		
All	Processor Applicability					Author	Rev 0	Cross Reference
	12					Approval H. Long	Date 8/17/72	

The Fortran Operating System sent out an LAP6-DIAL V2 will not work and will alter the tape mark track. This program is called "FORSYS" on the index. The paper tape version sent does work. Please inform your customers they can use the PIP program to put the paper tape version on DIAL.

On PDP12 systems that have trouble running the latest demo tape, set the A.C.I.P. delay to 160ms. This is true only if the problem manifests itself as a motion problem in searching for a particular block. Design Engineering is working on the final solution.

Title LAP 6 - DIAL						Tech Tip Software-TT-4 Number		
All	Processor Applicability					Author	Rev 0	Cross Reference
	12					Approval H. Long	Date 8/17/72	

Dial will not mark or copy properly, and has problems while operating. The M901 cable connectors used in the PDP12 have pins U1 and V1 routed through two 10 ohm resistors. Since the holes through the board are no longer plated through a bottom soldering will not ensure good electrical contact for these runs.

The solution is to resolder the resistors on the top of the run on all M901 cables in the field. Cable production will resolder any cables now being built. ECO M901-00001 will assure this does not happen in the future.

Title Focal '69 with API on PDP-12						Tech Tip Software-TT-5 Number		
All	Processor Applicability					Author	Rev 0	Cross Reference
	12					Approval H. Long	Date 8/17/72	

FOCAL '69 (DEC-08-AJAE), while executing its initialization code, issues a 6762 (clear TC01 status register A) which is also used in the new PDP-12 API (Automatic Priority Interrupt) hardware. Therefore, if you are running on a PDP-12 with API this instruction must be NOP'ed.

To correct this problem, do the following:

1. Set left switches = $\beta 2\beta\beta$
2. Set F stop key
3. LO FOCAL4K, β (from DEC-12-SE2E-U0)
4. When the machine halts, set left switches - 4376; right switches equal 7000; press the fill key
5. Make sure the machine is in PDP-8 mode, set the left switches = 0200
6. Press start left switches switch

To correct the DIAL System Tape (DEC-12-SE2E-U0) change the following tape block:

BLOCK = 237 WORD = 376 FROM = 6762 TOP = 7000

digital	FIELD SERVICE TECHNICAL MANUAL				Option or Designator
	12 Bit <input checked="" type="checkbox"/>	16 Bit <input type="checkbox"/>	18 Bit <input type="checkbox"/>	36 Bit <input type="checkbox"/>	SOFTWARE

Title PDP-12 DIAL-MS				Tech Tip Number SFTWR-TT-6		
All	Processor Applicability			Author	Rev 0	Cross Reference
	12			Approval H. Long	Date 09/14/72	

PATCH TO FORCE LINTAPE TO BE THE SYSTEM DEVICE

There are a number of occasions when it is desirable that DIAL-MS not use a disk as the system device, even though one is present on the system. Among these instances are the following cases:

- Using the FPP Assembler on a system with on DF32 disk: the Assembler requires DIAL-MS, but also requires that if DF32's are used as the system device, at least two must be present.
- Using Focal -12 under these same circumstances.
- Initializing a tape on a system with an inoperable or malfunctioning disk.
- Starting up DIAL-MS on a system in which the disk must not be overwritten, e.g., in a CL-12 or PS-12 situation.

The following patch to the DIAL-MS system tape solves this problem by allowing sense switch 0 to affect the choice of a system device. If SS0 is in the 0 position, DIAL-MS is initialized in the same manner as it currently is. If SS 0 is in the 1 position at the time of initialization, however, Lintape will be chosen as the same device regardless of what disk are present on the system.

BLOCK	REL. LOCN.	OLD VALUE	NEW VALUE
310	014	0	0440
310	015	0	6036
310	016	0	0002
310	017	0	5766
310	035	0011	6014

Title CP Test 3 (Linc Mode Instruction Test)				Tech Tip Number SFTWRE-TT-7		
All	Processor Applicability			Author	Rev 0	Cross Reference
	12			Approval H. Long	Date 09/14/72	

CP Test 3 checks for a set teleprinter flag at location 5054; if the flag is cleared, it does a jmp.-1 and waits for it to come up. However, the current page bit is not set (0200) and it end up on page 0 with resulting core gobbling gobbling.

Solution: LOC: 5055 is: 5054
should be: 5254

Title OS-8 DECTAPE FAILURES						Tech Tip Number SFTWRE-TT-8		
All 8's	Processor Applicability					Author D. Herbener	Rev 0	Cross Reference
						Approval F. Purcell	Date 12/01/72	

When using OS-8 DECTape Systems, the bootstrap loads information into field 8 and then 1 and begins executing at 7642 in Field 1. However the bootstrap starts at 7643. If the instruction in 7642 is a jump or IOT strange symptoms will occur. In fact it may appear as an intermittent hardware failure because if you try it two or more times the same results may be obtained. The DECTape may also be destroyed permanently if any DECTape IOT's are issued. A new version of)S-8 is coming out to correct this in a few months.

Title DEC X8 PATCH TO RANDOMIZE ROTATION						Tech Tip Number SFTWRE-TT-9		
All	Processor Applicability					Author D. Herbener/Shelley	Rev 0	Cross Reference
						Approval F. Purcell	Date 01/24/73	

Without a real time clock, DEC/X8 does not do a random job rotation. The following patches will allow rotation to be randomized.

1. If the machine does not have power fail change the following:

<u>Location</u>	<u>Contents</u>	
01617	- 7000	Change to 2177
01621	- 7240	Change to 5225

2. If the machine does not have a time share option, change the following:

<u>Location</u>	<u>Contents</u>	
01625	- 7000	Change to 2177
01627	- 6212	Change to 5232

NOTE: ONLY ONE OF THE ABOVE PATCHES NEED BE PUT IN AT ONE TIME.
IF YOU ANSWER "YES" TO POWER FAIL OR TIME SHARE DURING THE BUILDING PROCEDURE, LOCATIONS 01617 OR 01625 MAY NOT CONTAIN NOPS.

Rev. B of DEC-X8 monitor automatically does randomized rotation and above patches apply only to Rev. A.

digital	FIELD SERVICE TECHNICAL MANUAL				Option or Designator
	12 Bit <input checked="" type="checkbox"/>	16 Bit <input type="checkbox"/>	18 Bit <input type="checkbox"/>	36 Bit <input type="checkbox"/>	SOFTWARE

Title NEW TSS/8 RELEASE				Tech Tip Number SPTWRE-TT-10	
All	Processor Applicability		Author R. Wilson	Rev 0	Cross Reference
	8's		Approval R. Turcotte	Date 7/24/74	

A new version of TSS/8 (EDU-50) will soon be (or has been) released. This version is called 8.24 and replaces version 8.22B. The new monitor does things with the hardware that no other software (including diagnostics) has ever done. Therefore, hardware problems will show up at many sites. These problems should be fairly easy to locate, provided that the machine runs the old monitor dependably. The following comments may help to locate these problems. If problems persist, particularly in wierd configurations, please call Maynard X5901. We may know of someone else who has had the same problem.

A) The new monitor takes advantage of the fact that a DEC tape transport which is deselected while in motion continues to move, so that more than one tape can be moving at a time. When loading/dumping using INIT, all tapes should rewind and unload automatically. If one does not, that transport apparently does not work correctly. Under Monitor control, a bad symptom would be if 2 tapes were being used simultaneously, and one kept stopping for several seconds at a time when the other was selected.

B) The DTRA (6761) instruction is used to transfer the contents of DEC tape status A to the AC. If any bits are missing, TECTapes will behave strangely. Try executing 7240;6766;6761;7402. This loads status A and reads it back. The AC should be 7774 at the HLT. If this sequence is single-stepped, the AC will be 7574 instead.

C) If the system includes RK05, make sure the priorities are right. RF08 (or DF32) must be priority 0. RK8E must be priority 1 (install jumpers W2,W3,W5). DECTape will probably be priority 2. Make sure a priority is assigned! (KD8E-TT-2)

D) The RK8E uses the same device code as terminal line number 20 (16 decimal) in the old monitor. Therefore, in all existing time-share systems (except 8I/DC08A) with at least 17 (decimal) interfaces (KL8/E and such), the device codes for line 20 must be changed. The new device codes are:

LINE NUMBER	DEVICE CODES	LINE NUMBER	DEVICE CODES
K00	03/04	K12	52/53
K01	40/41	K13	54/55
K02	42/43	K14	56/57
K03	44/45	K15	70/71
K04	46/47	K16	36/37
K05	34/35	K17	72/73
K06	11/12	K20	06/07
K07	30/31	K21	14/15
K10	32/33	K22	16/17
K11	50/51	K23	05/65

PAGE 697	PAGE REVISION 0	PUBLICATION DATE July 1974
-----------------	------------------------	-----------------------------------

Title NEW TSS/8 RELEASE					Tech Tip Number SPTWRE-TT-10		
All	Processor Applicability				Author R. Wilson	Rev 0	Cross Reference
	8's				Approval R. Turcotte	Date 7/24/74	

E) For your convenience, here are the other device codes used by TSS/8:

ØØ:	Processor
Ø1-72	Reader/Punch
1Ø	Power Fail
13	Real time clock, except traditional 8.
20-27	Extended memory/time share
30-31	Clock, (traditional 8), and PTØ8/KL8E
4Ø-47	DCØ8A (8I) and PTØ8/KL8E
6Ø-62	RFØ8/DF32
63	Card reader and DF32 maintenance
64	RFØ8
66	Line Printer
67	Card Reader
7Ø-74	689AG modem controller (8I/DCØ8A)
74	RK8E and 689 AG modem controller.
75	RK8F on systems with 689
76-77	TCØ1/TCØ8

F) Just in case someone tries to put an RK8F on a PDP-8/I with a DCØ8A and 689AG, be aware that the RK8F and 689 use the same device codes. The device code of the RK8F must be changed to 75.

G) GDI optical-mark card readers on a PDP-8/I don't go "not ready" gracefully. (Reference Tech Tip CR8I-TT-3) If the customer complains of "hung device" messages on such a card reader, have him place a card in backwards at the end of the deck so that the timing marks will not be read. Monitor, finding zero columns, calls it end-of-deck.

H) For systems with DF32/DF32D disk, and for a card reader, the MAINTENANCE/OPERATE switch must be in the OPERATE position.

I) Some current installations have no high-speed reader. These customers will probably appreciate the use of a PMKØ1 for building the new monitor.

digital	FIELD SERVICE TECHNICAL MANUAL				Option or Designator
	12 Bit <input checked="" type="checkbox"/>	16 Bit <input checked="" type="checkbox"/>	18 Bit <input type="checkbox"/>	36 Bit <input type="checkbox"/>	SUPER COVER

Title	CORRECT USE OF SUPER COVER CABLE CLAMP			Tech Tip Number	SUPR CVR-TT-1
All	Processor Applicability	Author	Jeff Blundell	Rev	g
		Approval	Frank Purcell	Date	02/06/73
					Cross Reference

It is not true that cables need to be unplugged so that they can be threaded back through the hole in the rear of the super cover when you wish to remove the super cover for service.

The correct cable run is shown below:

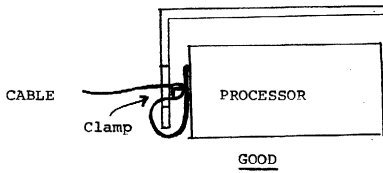
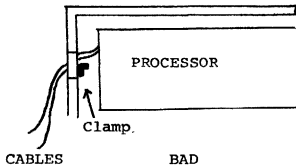

COMPANY CONFIDENTIAL

-- NOTES --

digital	FIELD SERVICE TECHNICAL MANUAL				Option or Designator TC01
	12 Bit <input checked="" type="checkbox"/>	16 Bit <input type="checkbox"/>	18 Bit <input type="checkbox"/>	36 Bit <input type="checkbox"/>	

Title TC01 DECTape Information				Tech Tip Number TC01 TT-1	
All Processor Applicability		Author Craig Showers	Rev 0	Cross Reference	
8E		Approval W. Cummins	Date 7-31-72		

In TC01 DECTape library system tape # DEC-08-SUCO-UB, the "Escape" program can cause two undeterminable locations of Rim Loader to be destroyed. This problem has been corrected on tapes now being issued.

Field Solutions:

1. Recopy Escape program from known good tape.
2. Reload Rim Loader after running "Escape" routine.

Title ERROR IN TC01 BASIC EXERCISER MAINDEC-08-D3BB-D				Tech Tip Number TC01-TT-2	
All Processor Applicability		Author	Rev 0	Cross Reference	
8		Approval W. Cummins	Date 6/6/72		

The error condition affects the write/read test starting at location 0204 with test pattern 6 selected.

Test pattern 6 is a 7070 pattern that is written on the DECTape, then read back to the processor and verified. The error causes the program to execute test pattern 6 only once, then the program selects test pattern 5 (0707) erroneously.

Error printouts could then occur for both test patterns. No significant testing of test pattern 6 can be made.

To correct error change location 4642 from 5630 JMP I GNPAT5
to 5636 JMP I GNPAT6.

Title ADJUSTMENTS FOR DECTAPE SYSTEMS - Family of 8				Tech Tip Number TC01-TT-3	
All Processor Applicability		Author Robert Nunley	Rev 0	Cross Reference CPL	
		Approval F. Purcell	Date 12/06/72	TU56-TT-9	

Title						Tech Tip	
PROBLEM WITH TC01-TU55 DECTAPE FORMATTER						Number TC01-TT-4	
All Processor Applicability			Author K. Wunderlich		Rev 0		Cross Reference
8's			Approval B. Hansen		Date 2/6/74		TU55-TT-7

The program TC01-TU55 Dectape Formatter, DEC-08-EUFB will write the correct mark track and timing track on the dectapes first specified by the user. However, following the statement "set switch to normal" and after the user resets the switch and types carriage return, the first dectape specified will go in reverse for some time and then switch to the forward direction writing the last reverse block number. At this point in time due to the current address not getting reset by the program after writing the Forward End Zone during the write timing and mark track pass location 1557 gets modified from 0040 to 0440. Location 1557 contains parts of the code for writing the Forward End Zone, therefore, any new dectapes puts on the drives after this will not have the correct forward end zone written on the mark track.

The error can be detected by the TD8-E Diagnostic, (Maindec-08-DHTDA) routine for checking the mark track and the routine to search and find all block numbers.

To avoid this the following change can be made:

Location	Old	New
1633	1161	4360
1760		0000
1761		1166
1762		3512
1763		1161
1764		5760

DEC-08-EUFB has been corrected and resubmitted to the Program Library as DEC-08-UDTFA-A.

digital	FIELD SERVICE TECHNICAL MANUAL				Option or Designator
	12 Bit <input checked="" type="checkbox"/>	16 Bit <input type="checkbox"/>	18 Bit <input type="checkbox"/>	36 Bit <input type="checkbox"/>	TC08

Title TC08 - Installing G829				Tech Tip Number TC08-TT-1		
All	Processor Applicability			Author	Rev g	Cross Reference
	8E			Approval W. Cummins	Date 07/31/72	

When installing the G829 for ECO TC08-00014, the module requires a 10 amp fuse.

Title ADJUSTMENT OF G888 (Read/Write Amp Module) TC08				Tech Tip Number TC08-TT-2		
All	Processor Applicability			Author J. Blundell	Rev A	Cross Reference
	8I			Approval F. Purcell	Date 04/19/73	

Due to lack of sufficient documentation, some confusion has developed over how to field-adjust this module.

The modules are set up in the plant by applying a lmv sine wave to input pins DZ and EZ; R7 is then adjusted for a symmetrical (e.g. 50/50) square wave at output pins U2 and V2.

Should it become necessary to field-adjust this module, the following alternate procedure may be used:

1. Refer to the Head Output Check section of the TU55 or TU56 Maintenance Manual (as appropriate) to check that the read head is capable of developing the proper read signals.
2. Install the module to be adjusted in slot A18 of TC08 (Timing Track), or slot A14 of the TU56 (if TD8E).
3. With the transport selected, observe the waveform at pins A18U2 and A18V2 and adjust R7, if necessary, to obtain a symmetrical square wave (a scope loop subroutine such as Test 210 of the DEctape Basic Exerciser may be used for this purpose).

NOTE: Due to the differences of the input signals used (e.g. lmv as compared with 10mv) this method is not as accurate as the ones used in Maynard; but it will provide satisfactory results in regards to field use.

Further general information on the modules and signal flow within the DEctape option is given in the related Maintenance Manuals. SEE especially the sections on theory of operation and maintenance in the TU56 manual and theory of operation, logical operation, checkout and maintenance, and modules in the TC08 manual.

COMPANY CONFIDENTIAL

Title DECTAPE TRANSPORT CABLES						Tech Tip Number TC08-TT-3	
All Processor Applicability				Author C. Sweeney		Rev 0	Cross Reference
8I 8L 8E				Approval W. Cummins		Date 6/6/72	

To connect a TC08 DECTape control to a TU56:

<u>CONNECT FROM</u>	<u>TO</u>	<u>CABLE TYPE</u>
TC08 A24	TU56 A06	70-6223*
TC08 A, B19	TU56 A, B10	74-5152-1

To connect a TU56 to a TU56:

TU56 A07	TU56 A06	BC02X-3
TU56 A, B11	TU55 A, B10	74-5152-1

To connect a TU56 to a TU55:

TU56 A07	TU55 A05	70-6223*
TU56 A, B11	TU55 A, B02	74-5152-1

To connect a TC08 to a TU55:

TC08 A24	TU55 A05	74-5151
TC08 A, B19	TU55 A, B02	74-5152-1

To connect a TC01 DECTape control to a TU56:

TC01 C32	TU56 A06	70-6223*
TC01 C, D19	TU56 A, B10	74-5152-1

To connect a TC01 to a TU55:

TC01 C32	TU55 A05	74-5151-1
TC01 C, D19	TU55 A, B02	74-5152-1

To connect a TU55 to a TU56:

TU55 A06	TU56 A06	70-6223*
TU55 A, B03	TU56 A, B10	74-5152-1

To connect a TU55 to a TU55:

TU55 A06	TU55 A05	74-5151-1
TU55 A, B03	TU55 A, B02	74-5152-1

* 70-6223 CAUTION: It is possible to install this cable backwards; see note on cable terminator to insure cable is installed properly.

digital	FIELD SERVICE TECHNICAL MANUAL				Option or Designator
	12 Bit <input checked="" type="checkbox"/>	16 Bit <input type="checkbox"/>	18 Bit <input type="checkbox"/>	36 Bit <input type="checkbox"/>	TC08

Title					MODULE		PLACEMENT FOR TC08		Tech Tip Number		TC08-TT-4	
All					Processor Applicability			Author		Rev		Cross Reference
								Bob Nunley		A		
								Approval		Date		
								Frank Purcell		07/31/72		

The following is a table of module placement for TC08.

	A	B	C	D
1.	G821	G821	M100/M101*	
2.	Cable	M633/M623*	M100/M101*	Cable
3.	Cable	M633/M623*	M100/M101*	Cable
4.	Cable	M633/M623*	M102/M103*	Cable
5.	Cable	M633/M623*	M102/M103*	Cable
6.	Cable	M111	M111	Cable
7.	M161	M207	M207	M161
8.	M206	M113	M121	M207
9.	M117	M206	M206	M121
10.	M113	M627	M121	M119
11.	M111	M115	M113	M206
12.	M113	M117	M115	M627
13.		M206	M111	M602
14.	M302	M206	M206	M307
15.	M627	M113	M113	M401
16.	M602	M602	M627	M302
17.			M111	M602
18.	G888	G888	M228	M228
19.	W032	W032		
20.	G888	G888		
21.	G888	G8790		
22.	M502	M633		
23.	M633	W005		
24.	Cable			
25.	Cable			
26.	Cable			

*Listed TC08N/TC08P for different busses.

Cables
A02-A06 & D02-D06 = I/O connectors
A19 - (W032) Data Cable to Transport
A24 - Command Cable to Transport
A25 - Indicators - Status A, unit select, etc.
A26 - Indicators - MC, Write, etc.

NOTE: M663 in A23 and B22 are not changed as polarity of IO bus is changed.

COMPANY CONFIDENTIAL

Title ADJUSTMENTS FOR DECTAPE SYSTEMS - Family of 8										Tech Tip Number TC08-TT-5					
All	Processor Applicability									Author Robert Nunley		Rev 0		Cross Reference	
											Approval Frank Purcel		Date 12/06/72		CPL TU56-TT-9

This tech tip is issued for cross reference purposes only.

COMPANY CONFIDENTIAL

DIGITAL EQUIPMENT CORPORATION

digital	FIELD SERVICE TECHNICAL MANUAL				Option or Designator
	12 Bit <input checked="" type="checkbox"/>	16 Bit <input type="checkbox"/>	18 Bit <input type="checkbox"/>	36 Bit <input type="checkbox"/>	TC12

Title DECTAPE - LINTAPE				Tech Tip Number TC12-TT-1		
All	Processor Applicability			Author	Rev 0	Cross Reference
	12			Approval H. Long	Date 8-17-72	

Repeat problems with tape crashes and/or oxide build-up on tape heads may be realted to customer using tape with open-coat oxide. Please ensure that only mylar-sandwich tape is used on DECTAPE or LINTAPE systems.

The backing on open-coat tape is reddish-brown in color while mylar-sandwich tape is tan.

Title MARK 12 FAILURE				Tech Tip Number TC12-TT-2		
All	Processor Applicability			Author	Rev 0	Cross Reference
	12			Approval H. Long	Date 8-17-72	

Problems with "TAPE CHECK FAILURE" in the Mark 12 program are related to the Mark Clock. If this is set to 7.6 uSec. instead of 7.5 uSec., a timing problem in the close window circuit is developed. With tapes moving backwards near block 000, the tape timing should approach 20 uSec. between pulses. If the Mark interval is too long, this time will be about 26-27 uSec., and interfere with MTP set up following a MTB command. Therefore, set the Mark Clock to EXACTLY 7.5 microseconds. EM12-00032 corrects this problem.

Title TC12 DELAYS				Tech Tip Number TC12-TT-3		
All	Processor Applicability			Author	Rev 0	Cross Reference
	12			Approval H. Long	Date 8-17-72	

A new revision (B) of the M307 retriggerable one shot will be available, replacing the jumper range selection by a 5 position switch. This card is pin-for-pin compatible.

Range is selected by screwdriver slot pointing to range 1-5, and fine adjustment by 20 turn pot. Ranges are:

1. 50 mSec - 500 mSec
2. 5 mSec - 50 mSec
3. 500 uSec - 5 mSec
4. 50 uSec - 500 uSec
5. 5 uSec - 50 uSec

This module will be used in TC12 delays

COMPANY CONFIDENTIAL

Title ACIP DELAY						Tech Tip Number TC12-TT-4		
All	Processor Applicability					Author	Rev 0	Cross Reference
	12					Approval H. Long	Date 8-17-72	

For accurate setting of this delay it is important to use the procedure in the PDP-12 adjustment manual. Most other procedures will cause both diagnostic and customer program failures. In some cases erroneous setting of this delay will prevent a true tape failure showing up on the diagnostic. Set the delay to 180 mSec. Any failures that occur are due to some other problem.

Title TAPE DATA FAILURES						Tech Tip Number TC12-TT-5		
All	Processor Applicability					Author	Rev	Cross Reference
	12					Approval H. Long	Date 8-17-72	

A missing wire has been noted in older (SN 400 and prior) EM12's. The symptoms are varied in system programs, but tape data test will show a solid, although undefined, problem.

Signal Name From To
LGP GPCNT 0 (0) H B31F1 C25M1

All EM12's should be checked for this run.

Title TAPE DATA EXERCISER FAILURES						Tech Tip Number TC12-TT-6		
All	Processor Applicability					Author	Rev 0	Cross Reference
	12					Approval H. Long	Date 8-17-72	

Maindec 12-D3DA and later may show untraceable failures in the "Move Toward Block" portion (error 3). Several In-House systems exhibiting this problem were repaired by swapping the M212 in A38 (tape window).

Although the M212 is functioning properly, it has slow propagation time and does not decode the block mark window in enough time to set up the TBN → TAC → AC transfer.

There are two M212 modules used in the MQ register which may be swapped with the mark window. Slow propagation, will in most cases not affect the MUL instruction. It may be checked by running CPTTEST 1.

Title TAPE CONTROL TEST PART 1 & 2 FAILURES						Tech Tip Number TC12-TT-7		
All	Processor Applicability					Author	Rev 0	Cross Reference
	12					Approval H. Long	Date 8-17-72	

TC12 1 and TC12 2 starting procedures specifies "Start 200, 8 mode". Starting either diagnostic at this address may cause an spurious error. Both diagnostics should "Start 20, 8 Mode".

TC 2 in particular, if started at 0200, will type the following

- "LIP TAPE DONE FAILED TO SET".

COMPANY CONFIDENTIAL

digital	FIELD SERVICE TECHNICAL MANUAL				Option or Designator
	12 Bit <input checked="" type="checkbox"/>	16 Bit <input type="checkbox"/>	18 Bit <input type="checkbox"/>	36 Bit <input type="checkbox"/>	TC12

Title ILLEGAL INSTRUCTION SEQUENCE			Tech Tip Number TC12-TT-8
All	Processor Applicability	Author	Rev 0
12		Approval H. Long.	Date 8-17-72
			Cross Reference

Problem Description: With "Hold Motion" set and "No Pause" mode set, it is impossible to do two back to back tape instructions on units 1 and 0 and enable motion on both tape transports simultaneously

Solution: None. This sequence of instructions is illegal due to timing restrictions in the tape control (notably, Mag Tape set-up) and cannot be corrected. Customers desiring this function should be advised that they must delay the second tape instruction by at least 4 uSec. to be assured reliable operation.

COMPANY CONFIDENTIAL

NOTES

CPL

digital	FIELD SERVICE TECHNICAL MANUAL				Option or Designator TC58
	12 Bit <input checked="" type="checkbox"/>	16 Bit <input type="checkbox"/>	18 Bit <input checked="" type="checkbox"/>	36 Bit <input type="checkbox"/>	

Title MAGNETIC TAPE CONTROLS TC58, TC59				Tech Tip Number TC58-TT-1	
All Processor Applicability		Author		Rev	
8's		Approval W. Cummins		Date 06/06/72	
				Cross Reference	

- The EOF character while reading gets stored in memory location specified by the initial address.
- A recent ECO change which informs the program that the selected magnetic tape unit is settling down is OR'ed with the illegal status bit (Bit 3). This added status information is present only during the transport settling period after the drive was instructed to stop. (TU20 settling time - 5 ms) Ref: PDP-8/1 Handbook, Pages 177 and 178. (PDP-8 ECO #279).
- The TC58 extended memory field is loaded by the MTGO command in which AC Bits 6, 7, 8, are loaded in the data field bits 0, 1, 2, respectively.
- Under certain long data blocks using a nine track system, the CRC character and LPCC character may be identical and equal to the end of file code. A space reverse command will consider the LPCC and CRC character as an EOF thus causing tape shut down procedures. This will be corrected in the near future.
- Remember if a record is written in even parity mode (BCD), a zero character will contain no bit in the parity channel. If two consecutive characters contain zeros, the control may begin shut down procedures.

Title CHECKING 9 CHANNEL TC58 MAG TAPE SYSTEM				Tech Tip Number TC58-TT-2	
All Processor Applicability		Author W. Freeman		Rev 0	
8's		Approval W. Cummins		Date 06-06-72	
				Cross Reference	

When checking for data errors on a 9 channel TC58 system, it is necessary to run TC58 Instruction Test 1 (Maindec 08-D9DB) and TC58 Instruction Test 2 (Maindec 08-D9EA) because the CRC data is checked only with these maindecs; it is not checked by Maindec 08-D9FA TC58 Data Reliability Test (9 track). The CRC is calculated and written on tape by hardware in the TC58 control. No hardware checks are made on the CRC, therefore, the CRC must be checked by software during a read operation.

COMPANY CONFIDENTIAL

Title ERROR IN TC58 RANDOM EXERCISER						Tech Tip Number TC58-TT-3		
All	Processor Applicability					Author R. Nunley	Rev 0	Cross Reference
	8	8				Approval W. Cummins	Date 7-31-72	

There is a deficiency in the TC58 Random Exerciser (Maindec-08-D9CC) that causes symptoms which may be interpreted as a TC58 hardware failure because the end-of-tape (EOT) can be missed and the program will continue until the tape runs off the reel. This can happen because the interrupt handling routine does not check for EOT while doing an end-of-file (EOF). During EOF a TC58 interrupt causes its status register to be read, but all bits, except the one representing EOF, are masked out. Any function causing an interrupt from the TC58, other than an EOF, will therefore be missed. The following patch entered manually, after the Maindec has been read into core, will allow recognition of EOT while doing an EOF.

Address New Contents

3326	4340	
3340	0	Enter
3341	7300	CCA CLL
3342	6706	Read Status
3343	6712	Clear Status
3344	0353	Mask for EOT?
3345	7650	SNA SZA - EOT?
3346	5740	Not EOT So Leave
3347	1354	(Set Up to
3350	3500	(Enter EOT
3351	3430	(Routines
3352	5740	Go to EOT routines
3353	0040	
3354	3101	

Title TC58, TC59 Drive Function Timer						Tech Tip Number TC58-TT-4		
All	Processor Applicability					Author Fred Doll	Rev 0	Cross Reference TC59-TT-1 18 Bit Manual
	8					Approval W. Cummins	Date 11/03/72	

Drive Function Timer MAINDEC-9-D4CC, 8-D9BA, 15-D4CC and earlier versions may hang in the bad tape test after installing ECO TC59-14 or TC58-09. To correct, change the following locations which are about 100 locations prior to the bad tape test.

MAINDEC	ADDRESS	OLD CONTENTS	NEW CONTENTS
9-D4CC	2367	LAC /WR BUF-1 203501	LAC/WRBUF+BLENTH-10 203604
15-D4CC	2273	LAC/WRBUF-1 203415	LAC/WRBUF+BLENTH-10 203511
80D9BA	2705	TAD K3777 1063	TAD K6515 1067

COMPANY CONFIDENTIAL

digital	FIELD SERVICE TECHNICAL MANUAL				Option or Designator TD8E
	12 Bit <input checked="" type="checkbox"/>	16 Bit <input type="checkbox"/>	18 Bit <input type="checkbox"/>	36 Bit <input type="checkbox"/>	

Title TD8E DECTape Formatter				Tech Tip Number TD8E TT-1	
All Processor Applicability		Author Ken Quinn	Rev 0	Cross Reference	
8E		Approval W. Cummins	Date 7-31-72		

It is possible to get intermittent mark timing errors when using DEC-8E-EUZH-PB DECTape formatter. The problem is corrected in DEC-8E-EUZH-PB, and this tape should be used. A temporary fix is to change location 1600 of the formatter from 1163 to 7200.

Title TAPE RUNAWAY				Tech Tip Number TD8E-TT-2	
All Processor Applicability		Author Ken Quinn	Rev 0	Cross Reference	
8E	8M	8F	Approval W. Cummins		

Due to the effect of circuit delays in the M868 and the TU56, a tape runaway may be observed on unit 1, 3, 5, or 7 while running the TD8E DECTape Diagnostic (MAINDEC8E-D3AB). This is caused by an instruction sequence of:

- A. SDLC (All 1's)
CAF
- B. SDLC (All 1's)
SDLC (All 0's)

To Correct MAINDEC-8E-D3AB toggle in the following patch after the program has been loaded:

<u>Address</u>	<u>Change To</u>
0314	1365
0365	6400
0405	1364
0564	6777

A new MAINDEC will be available in the Program Library in the near future. The new MAINDEC number is MAINDEC-08-DHTDA-A, and it will incorporate all previous MCN's.

Because the circuit delays may cause this type of a program, a drive should always be stopped by clearing the Stop/Go flip-flop (AC Bit 2) before clearing the unit flip-flop.

COMPANY CONFIDENTIAL

Title						Tech Tip	
DHTDA DECTape Diagnostic						Number TD8E-TT-3	
All	Processor Applicability					Author	Rev
	8E	8F	8M			Bill Connors	0
						Approval	Cross Reference
						Bud Lawrence	Date 1/7/74

During the data transfer portion of the new TD8E DECTape diagnostic MAINDEC-08-DHTDA-A, only one out of every 1008 blocks of the DECTape is exercised; that is, the diagnostic reads and writes 2008 words in blocks 0, 100, 200, ... 2700, 2701, 2501, ... 1 of the first drive, tests the same blocks on the next drive (if another is to be tested), and then starts over again with the first drive and another data pattern.

If you suspect intermittent read-write problems on a TD8E, you will need to read and write more often than the diagnostic presently does. Page 10 of the document lists two changes that will speed up the action; the "block increment" value can be decreased from its initial value of 0100, and the "highest block exercised" value can be decreased from its initial value of 2701. A patch is also included below, which is not listed in the document, to allow you to select a "lowest block exercised" value other than zero.

To change "block increment":

Loc	Old	New	
3154	0100	XXXX	New "block increment" value
3146	7700	XXXX	Two's complement of location 3154

To change "highest block exercised":

Loc	Old	New	
3152	2701	XXXX	New "high block" number
3153	5077	XXXX	Two's complement of location 3152

To change "lowest block exercised":

Loc	Old	New	
3032	3027	4114	
3127	1027	4121	
0114	*	0	
0115	*	1120	Tad low blk
0116	*	3027	DCA blk
0117	*	5714	Return
0120	*	XXXX	New "low block" number
0121	*	0	
0122	*	1120	Tad lo Blk
0123	*	7041	CIA
0124	*	1027	Tad blk
0125	*	5721	Return

digital	FIELD SERVICE TECHNICAL MANUAL				Option or Designator
	12 Bit <input checked="" type="checkbox"/>	16 Bit <input type="checkbox"/>	18 Bit <input type="checkbox"/>	36 Bit <input type="checkbox"/>	Teradyne

Title				CHECK OF TERADYNE J259		Tech Tip Number TT#1	
All	Processor Applicability			Author	W. Freeman	Rev	g
	8			Approval	W.E. Cummins	Date	11/15/73
							Cross Reference

QUICK CHECK OF COMMUNICATIONS BETWEEN TERADYNE J259 AND PDP-8, 81, 8L

3200	7300	CLA CLL
3201	7404	OSR
3202	3217	DCA PATTERN
3203	1217	TAD PATTERN
3204	6351	IOT TO INDICATE A LOAD COMMAND IS NEXT
3205	6341	XFER AC TO J259
3206	6342	SKIP ON J FLAG
3207	5206	JMP *-1
3210	5200	JMP BEGIN
3211	6344	XJ259 TO AC
3212	7041	CMA IAC
3213	1217	TAD PATTERN
3214	7440	SZA
3215	7402	HLT DATA ERROR
3216	5200	JMP BGN
3217	7777	PATTERN

- 1.) Key the above program into memory and start at 3200. Visually inspect the J259 for the following conditions:
 - a) "Load Command" light is on
 - b) The pattern which is displayed in the headquarters data lights should correspond to various settings of the switch register on the computer.
- 2.) Stop the program and change location 3210 to 7000 (NOP). Restart the program at 3200. Program will now cycle, sending into the J259 and reading it back and verifying. Error halt is 3213.
- 3.) Stop the program and change location 3204 to 6352 (IOT to indicate that load value command is next). Restart the program at 3200. Observe that headquarters "Load Value" light is on.
- 4.) Stop the program and change location 3204 to 6353 (IOT to indicate that load crosspoint command is next). Restart the program at 3200. Observe that headquarters "Load Crosspoint" light is on. END OF TEST

COMPANY CONFIDENTIAL

Title		8L CABLING ERROR		Tech Tip Number	Teradyne TT#2
All	Processor Applicability			Author	Rev
	8L			W. Freeman	g
				Approval	Date
				W. E. Cummins	11/15/73
					Cross Reference

Peculiar cabling arrangements between PDP-8L's and BA08 peripheral expanders have been noted in some Teradyne systems. The abnormal routing is 8L to Teradyne interface to BA08; this is incorrect and will lead to intermittent problems.

Correct cabling is PDP-8L to BA08 to Teradyne equipment.

COMPANY CONFIDENTIAL

digital	FIELD SERVICE TECHNICAL MANUAL				Option or Designator
	12 Bit <input checked="" type="checkbox"/>	16 Bit <input checked="" type="checkbox"/>	18 Bit <input checked="" type="checkbox"/>	36 Bit <input checked="" type="checkbox"/>	TERMINALS to TEST EQUIPMENT

Title TERMINAL INTERFACE CONNECTORS				Tech Tip Number TERM-TT-1	
All		Processor Applicability	Author Allan Kent	Rev 0	Cross Reference
			Approval Lou Nay	Date 01/23/73	

The standard pin assignments for the 8-pin mate-n-lock connectors used for 20 mA teletype loops are as follows:

<u>Pin Number of Female Connectors</u>	<u>Description</u>
1	Not used
2	+ Output (of device on which mounted)
3	- Input (to device on which mounted)
4	Reader Run - (33 ASR only)
5	- Output (of device on which mounted)
6	Reader Run +
7	+ Input (to device on which mounted)
8	- 30 V (special application only)

Thus a cable to connect two (otherwise compatible) devices has male mate-n-lock connectors wired as:

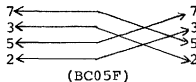

The following correspondences hold

	Terminal Devices (LA30 etc)	Terminal Interfaces (DC11 etc)
"Output" (above)	Keyboard, Reader	Printer, Punch Ckt.
"Input" (above)	Printer, Punch Ckt.	Keyboard, Reader Ckt.

There are two known exceptions to this rule: The VT05 (A & B) and the RT02. They have the inputs and outputs swapped and thus require a cable wired as follows:

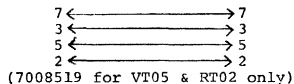

These two cables and their connectors appear identical. Be sure you have the correct one when servicing equipment.

COMPANY CONFIDENTIAL

Title PROBE SLIP-ON COVER TO AID I.C TROUBLESHOOTING						Tech Tip Number T. Equip-TT-1		
All	Processor Applicability					Author H. Fitek	Rev 0	Cross Reference
X						Approval	Date 9/14/72	

There is an attachment available which fits on the oscilloscope probe (Tek 013-0105-00 and P 6010) and prevents short circuiting to the next component lead. It provides insulation and a U-shaped tip which prevent slipping. It will be in the newly issued tool kits, but to order it for existing kits use #29-19553. (Cost \$.05)

Title FAN ASSEMBLY FOR TESTERS						Tech Tip Number Test- Equipment-TT-2		
All	Processor Applicability					Author RON PELLETIER	Rev 0	Cross Reference
X						Approval Ray Turcotte	Date 7/2/74	

There have been thermal problems with testers which are used for extended periods at a time. To remedy this problem, a fan assembly has been built which can be mounted in the chassis of all testers with the exception of UDC-TA and PMR01 which have to have holes drilled in their cases. The fan assembly can be ordered under the following number: 7010023-00. For further information contact Ron Pelletier Ext. 4742.

COMPANY CONFIDENTIAL

digital	FIELD SERVICE TECHNICAL MANUAL				Option or Designator
	12 Bit <input checked="" type="checkbox"/>	16 Bit <input type="checkbox"/>	18 Bit <input type="checkbox"/>	36 Bit <input type="checkbox"/>	TR02

Title ILLEGAL INTER RECORD GAP CHARACTERS				Tech Tip Number TR02-TT-1	
All Processor Applicability		Author C. Sweeney	Rev 0	Cross Reference	
8's		Approval W. Cummins	Date 7-31-72		

Problem - During a normal READ operation, if the program is such that the computer HALTs after reading a record of data; and the computer START key is depressed at this time; a full character frame of bits may be written on tape.

This condition occurs when the computer START key is depressed: because:

- a) The computer originated signal INITIALIZE enters the TR02 interface and derives a signal called \emptyset INIT B L: the latter signal resets the R/W flip-flop (among others). In the reset state, the R/W flip-flop indicates a WRITE function to the PEC transport.
- b) The same INITIALIZE signal leaves the TR02 interface as a pulse called REMOTE RESET: this REMOTE RESET signal is used in the PEC transport to generate a GRS (General Reset) pulse that clears all control flip-flops and the WRITE buffers.
 - 1) If the TR02 R/W flip-flop is reset and a WRITE LOCK ring is on the tape supply reel when a GRS occurs, a character will be written on tape within the Inter-Record Gap.

Solution - The way to correct this problem is to isolate the effects of INITIALIZE from the R/W flip-flop.

Two things are necessary to effect the solution: replacement of the M216 at TR02 location A14 with an M206, and related wiring changes in the area of A14 to allow the new module to operate correctly.

MODULE: Replace M216 in TR02 location A14 with an M206 on which the tabs FF1 and FF2 are jumpered to the K2 tabs; this allows isolation of FFO reset line from the other FF's on the board; the output F2 (\emptyset INIT A L) on the M111 at location A08 is quite capable of handling the additional loads of FF1 and FF2.

WIRING: Because of the layout of the M206, the logic positions of FFO and FF1 must be reversed (see interface print TR02-NP-3); (it is desired that the DIRECT CLEAR input of FFO (A1 of M206) be controlled by the signals \emptyset REWIND L and \emptyset WR LD L; provision must also be made for \emptyset REWIND L to be able to "force" an \emptyset INIT A L)

The following diagrams depict the exact nature of the change.

Title Illegal Inter-record Gap Characters (Continued)						Tech Tip Number TR02-TT-1		
All Processor Applicability						Author C. Sweeney Rev 0		Cross Reference
8's						Approval W. Cummins Date 6/6/72		

Add/Delete Scheme

SIGNAL NAME	RUN	ADD	DEL
∅ WR SET (1) H	A14E1 - A17H2		X
A16N2	A14F2 - A16N2		X
∅ READ L	A10T2 - A14J2		X
∅ READ/WRITE (1) H	A17E2 - A14H2		X
A17F2	A14D1 - A17F2		X
A16N2	A14F2 - B20J1		X
∅ READ/WRITE (1) H	A14H2 - A10M2		X
A11C1	A08E2 - A11C1		X
∅ REMOTE RESET L	A11B1 - A11P1		X
∅ REMOTE RESET L	A11B1 - A24K2		X
A11C1	A08V1 - A11C1		X
∅ REMOTE RESET L	A11P1 - A24K2	X	
∅ WR LD L	A12J2 - A11B1	X	
A16R2	A16R2 - A08E2	X	
∅ REMOTE RESET L	A16P2 - A06K1	X	
A11C1	A08V1 - A11C1	X	
∅ WR SET (1) H	A14H2 - A17H2	X	
A16N2	A14D1 - A16N2	X	
∅ READ L	A10T2 - A14F1	X	
∅ READ/WRITE (1) H	A14E1 - A17E2	X	
A17F2	A14F2 - A17F2	X	
A16N2	B20J1 - A16N2	X	
∅ WR SET (1) H	A10M2 - A14E1	X	
D664 DIODE	(CATHODE AT A11A1;	X	
	(ANODE AT A06K1		

digital**FIELD SERVICE TECHNICAL MANUAL**

Option or Designator

12 Bit 16 Bit 18 Bit 36 Bit TR02 TO
TR05Title **Illegal Inter-record Gap Characters (Continued)**Tech Tip
Number

TR02-TT-1

All
8's

Processor Applicability

Author C. Sweeney

Rev 0

Cross Reference

Approval W. Cummins

Date 06/06/72

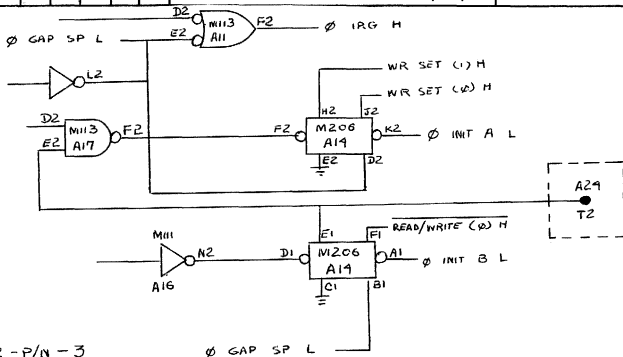

TR02-P/N-3

Page 1 of 4

FUNCTION CONTROL

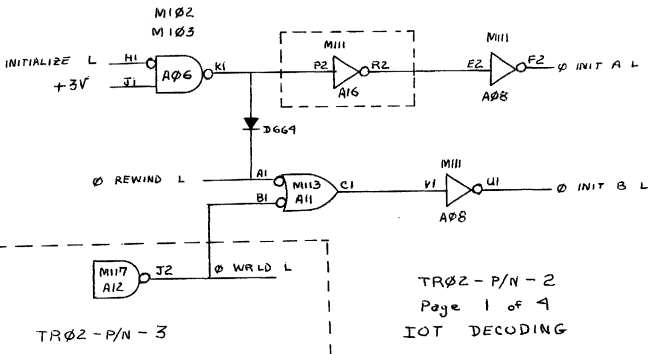

TR02-P/N-3

TR02-P/N-2
Page 1 of 4
IOT DECODING**COMPANY CONFIDENTIAL**

PAGE 721

PAGE REVISION U

PUBLICATION DATE July 1972

Title		INCOMPATIBILITY BETWEEN OLD AND NEW REVISION REEL SERVO BOARDS IN P.C. TRANSPORTS				Tech Tip Number		TR02-TT-2		
All	Processor Applicability					Author	Chuck Sweeney	Rev	0	Cross Reference TU28-TT-1 (CPL)
	8	8I	8L			Approval	Frank Purcell	Date	07/31/72	

Title		RINGING ON M302 OUTPUT				Tech Tip Number		TR05-TT-1		
All	Processor Applicability					Author	Sweeney/MacLeod	Rev	0	Cross Reference M302-TT-1
	8I					Approval	F. Purcell	Date	11/20/72	

This Tech Tip is issued for cross reference purposes only.

COMPANY CONFIDENTIAL

digital	FIELD SERVICE TECHNICAL MANUAL				Option or Designator
	12 Bit <input checked="" type="checkbox"/>	16 Bit <input checked="" type="checkbox"/>	18 Bit <input checked="" type="checkbox"/>	36 Bit <input checked="" type="checkbox"/>	TU10

Title TU10 TERMINATION					Tech Tip Number	TU10-TT-1	
All	Processor Applicability				Author Fred Doll	Rev 0	Cross Reference
X					Approval W. Cummins	Date 06-28-72	

If a system has TU20's and/or TU30's mixed with TU10's it is recommended that a TU10 be the last transport on the bus *. This allows the TU10 to terminate the bus with the three G741 terminator modules placed in A or B 17, 18, and 19.

* Note: Not applicable to DFC-System 10 TU10A. TU10A is use BC10L cables for the device bus, with a H868 transport H bus terminator.

Title TU10 ADJUSTMENTS					Tech Tip Number	TU10-TT-2	
All	Processor Applicability				Author F. Doll	Rev 0	Cross Reference
X					Approval W. Cummins	Date 07/06/72	

Early TU10 Maintenance Manuals tells you to use a skew tape to adjust the rewind speed in Sec. 5.3.4. An all ones tape should be used instead since a skew tape should never be rewound or used in a stop-start test. Refer to Page 5-9 of Maintenance Manual DEC-00-TU10S-DB.

Title TU10/TU20 DISSIMILARITIES					Tech Tip Number	TU10-TT-3	
All	Processor Applicability				Author F. Doll	Rev 0	Cross Reference
X					Approval W. Cummins	Date 07/06/72	

The TU10 unlike the TU20 will presently go off line when a rewind command is issued from the controller if the write enable ring is removed. An ECO is pending to eliminate this condition.

COMPANY CONFIDENTIAL

Title						TU10 TERMINATOR MODULES		Tech Tip Number		TU10-TT-4		
All		Processor Applicability				Author		C. Cline/Fischer		Rev 0		Cross Reference
X						Approval		W. Cummins		Date 7-31-72		

The TU10 Maintenance Manual does not clearly define how or what should be used in termination of TU10's. What is needed is three G741 terminator modules placed in A or B17, 18 or 19 of the last TU10 on the system. Also if you have TU20's mixed with TU10's, it is recommended to have the TU10 last on the bus with the above termination installed.

Title						TU10 Read and Write Slice Levers		Tech Tip Number		TU10-TT-5		
All		Processor Applicability				Author		Cline/Court		Rev A		Cross Reference
X						Approval		W. Cummins		Date 12/06/72		

Pages 5-17 of the TU10 DEC Magtape Maintenance Manual, Section 5.3.9 and adjustment has an error in Step 3, Step 3 should read "Connect Channel to pinB31L2 and not B32L1".

Title						TU10 CONVERSIONS		Tech Tip Number		TU10-TT-6		
All		Processor Applicability				Author		Fred Doll		Rev 0		Cross Reference
X						Approval		Dick Edwards		Date 9/18/72		

- A. To convert 7 channel units to 9 channel:
1. Remove 7 channel head assembly (70-06758-2) and head cables (19-10577-2 and 12-10577-4).
 2. Observe polarity of the erase head cables. The black wire is farthest from the TU10 casting or closest to the operator.
 3. Add 9 channel head assembly (70-06758-1) and head cables (12-10577-1 and 12-10577-3).
 4. Remove 7 channel logo 74-09294-0-0 and add 9 channel logo 74-09373-0-0.
 5. Add jumper from A21J1 to ground A21C2.
 6. Modify M768 as illustrated below.
 7. Deskew unit as per chapter 5 of the TU10 Maintenance Manual.

COMPANY CONFIDENTIAL

DIGITAL EQUIPMENT CORPORATION

digital	FIELD SERVICE TECHNICAL MANUAL				Option or Designator
	12 Bit <input checked="" type="checkbox"/>	16 Bit <input checked="" type="checkbox"/>	18 Bit <input checked="" type="checkbox"/>	36 Bit <input checked="" type="checkbox"/>	TU10

Title TU10 CONVERSIONS (Continued)				Tech Tip Number TU10-TT-6	
All	Processor Applicability		Author F. Doll	Rev 0	Cross Reference
X			Approval D. Edwards	Date 9/18/72	

B. Converting 60 Hz Machines to 50 Hz;

1. Remove 60Hz hourmeter 12-01208 from the H730 power supply and add 50 Hz hourmeter 12-02234.

C. Converting 115V to 230V

1. Remove 115V jumper assembly 70-07175 from the 54-08924 power control module and add 230V jumper assembly 70-07176.
2. This conversion is restricted to H730 supplies with the T91470 transformers. Supplies with the T9147B transformers cannot be converted in this manner.

D. Extreme voltage operation:

Later units with the T9147D transformer have extra primary taps to cover extreme voltage ranges. Simply resolder the wires going to terminals 2 and 4 to 2L or 2H and 4L to 4H respectively.

COMPANY CONFIDENTIAL

Title TU10 CONVERSIONS (CONTINUED)						Tech Tip Number TU10-TT-6	
All X	Processor Applicability				Author Fred Doll	Rev 0	Cross Reference
					Approval Dick Edwards	Date 9/18/72	

95-115 VAC, 190-230 VAC 2L, 4L
105-125 VAC, 210-250 VAC 2, 4
115-135 VAC, 230-270 VAC 2H, 4H

M 768

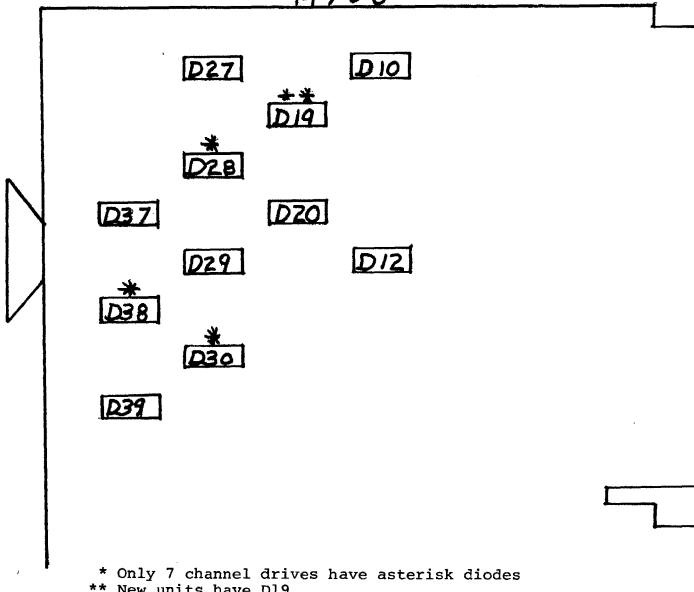

COMPANY CONFIDENTIAL

DIGITAL EQUIPMENT CORPORATION

digital	FIELD SERVICE TECHNICAL MANUAL				CPI Option or Designator
	12 Bit <input checked="" type="checkbox"/>	16 Bit <input checked="" type="checkbox"/>	18 Bit <input checked="" type="checkbox"/>	36 Bit <input checked="" type="checkbox"/>	TU10

Title					TU10 HEAD ASSEMBLY		Tech Tip		Number TU10-TT-07		
All	Processor Applicability				Author	Fred Doll		Rev	0		
X					Approval	Dick Edwards		Date	12/6/72		
								Cross Reference			

The head and tape cleaner are not to be adjusted in the field. The tape guides are not to be adjusted more than 10 degrees from their initial settings. If any of the above are performed the head assembly must be returned to Maynard for realignment.

COMPANY CONFIDENTIAL

Title M895 READ TIMING MODULE						Tech Tip Number TU10-TT-8	
All		Processor Applicability		Author Harry Drab		Rev A	Cross Reference
X					Approval Jim Barclay	Date 6/5/73	

The M895 Read Timing Module has undergone several revisions lately to correct a number of problems. The following points describe the FCOs by number, indicating problems fixed and dates, where applicable.

<u>FCO #</u>	<u>PROBLEM</u>
3	Created CS Rev F, Etch Rev F. Neither of these revisions ever got into production.
4	Created CS "F", Etch "E". Corrected timing algorithm to allow consistent detection of an all-zero CRC character. Prior C.S. revisions will occasionally fail to read in an all-zero CRC, generating CRC errors. Also corrected problem with multiple file-mark strobes (TM8/e problem only).
5	Created CS "H", retrofit only. Corrected rare condition in CS Rev F. This FCO must be installed as a retrofit on all M895's with etch Rev "E".
6	Created CS rev's "D1" and "J", left current etch Rev at "E", retrofit only. Corrected problem in which TU10 on TM11 runs away, writing same character on tape for length of tape. During runaway, signals CWDRH and LPCSH are both asserted. D1 Rev corrects runaway problem, but can still be fooled by an all-zero CRC character. Boards at etch level C, D, or F should be retrofitted to CS Rev D1 whenever the runaway problem is suspected. "E" Rev boards retrofitted to CS Rev "J" correct all known problems at this time.

As of 3/16/73, Puerto Rico is just turning on to build Etch Rev "H" boards. Most ships prior to 5/1/73 of TU10M units will have M895 modules at CS Rev D or D1. Date of FCO #6 is 3/19/73.

Note: TM11 users reference TM11-TT-02

COMPANY CONFIDENTIAL

digital	FIELD SERVICE TECHNICAL MANUAL				CPL Option of Designator
	12 Bit <input type="checkbox"/>	16 Bit <input checked="" type="checkbox"/>	18 Bit <input checked="" type="checkbox"/>	36 Bit <input checked="" type="checkbox"/>	TU10

Title FILTER REPLACEMENT					Tech Tip Number TU 10-TT-0 9	
All	Processor Applicability			Author FRED DOLL	Rev 0	Cross Reference
X				Approval DAVE STARRATT	Date 5/9/73	

The maintenance manual calls for teflon tape when replacing reel motor filters. This tape, a common pipe thread sealant, had DEC # 90-09358 assigned.

Title RUN TIME MEASUREMENTS					Tech Tip Number TU10-TT-10	
All	Processor Applicability			Author FRED DOLL	Rev 0	Cross Reference
X				Approval DAVE STARRATT	Date 5/9/73	

TU10's have two time meters. The meter mounted on the H730 power supply operates whenever the power switch is on. This meter can only be used as a guide for measurement of vacuum on time since the vacuum motor only operates when the power switch is on and the tape is loaded. A small meter mounted below the logic rack (DEC # 12-10721) is connected to the forward flip flop pins (RED LEAD A25R2-BLACK LEAD A25T1) and indicates actual run time.

Title HEAD ASSEMBLY CHANGE					Tech Tip Number TU10-TT-11	
All	Processor Applicability			Author FRED DOLL	Rev 0	Cross Reference
X				Approval DAVE STARRATT	Date 5/9/73	

Two jacking screws have been added to the TU10 head assembly to reduce reverse skew by aligning the head assembly more accurately with the left buffer column. The adjustment procedure for the head assembly is not in maintenance manuals printed before January 1973. New Rev manuals, DEC-00-HTUMM-D-D, are available from Communications Services-Publications Distribution.

COMPANY CONFIDENTIAL

Title						ERRATIC OR EXCESSIVE SKEW		Tech Tip Number		TU10-TT-12	
All		Processor Applicability				Author		Fred Doll		Rev 0	
X						Approval		Fred Doll		Date 5/1/74	
										Cross Reference	

If erratic or excessive skew is observed make the following check:

Mount head cover to transport by manually pressing the cover on till it fully "seats." With the buffer column door open check to see if the cover clears the upper and lower shoulders of the head mounting plate. (These shoulders mount the tape guide assemblies). Be sure the head cover is "bottomed" to the deck casting surface but do not attempt forcing. If at least 1/64 inch appears to exist the cover is o.k. If not install a nylon washer (DEC #90-06710) on the upper and lower stand-off shafts that secure the head cover. The washers are a "press-fit" and will not fall off once installed should the head cover be removed in the field. Tighten cover captivating screws and check again for clearance.

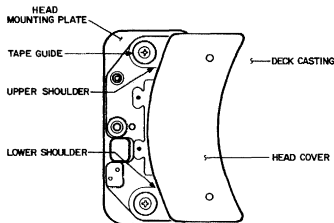

10-1335

Title						TM8E/TU10 (TC58) PM Procedure		Tech Tip Number		TU10-TT-13	
All		Processor Applicability				Author		D. Staupe		Rev 0	
8's						Approval		D. Staupe		Date 5/10/74	
										Cross Reference	
										TM8E-TT-2	

A comprehensive preventive maintenance procedure for the TU10 including adjustments in table form with pictures of the expected signals can be obtained through the publications stockroom.

TM8E(TC58)/TU10 Preventive Maintenance Procedure..DEC-08-HHTMA-D

CPL

digital	FIELD SERVICE TECHNICAL MANUAL				Option or Designator
	12 Bit <input checked="" type="checkbox"/>	16 Bit <input checked="" type="checkbox"/>	18 Bit <input checked="" type="checkbox"/>	36 Bit <input checked="" type="checkbox"/>	TU10

Title Proper Part Numbers for Vacuum Motors & Brushes					Tech Tip Number	TU10-TT-14			
All	Processor Applicability				Author	Jim Lingle	Rev	<input checked="" type="checkbox"/>	Cross Reference TU20-TT TU30-TT
X					Approval	Dick Odem	Date	10/4/74	

Presently, two different vacuum motors are being used in the field and both motors are directly interchangeable with one another.

DEC P/N 29-12263 vacuum motor is being replaced by DEC P/N 12-05944-00. The brushes used by these motors are different and cannot be mounted on the opposite motor type. To identify the new versus the old motor type and the correct brushes, please refer to the chart below.

	<u>DEC P/N</u>	<u>Lamb Elec. P/N #1</u>	<u>H. P. P/N</u>
New Motor	12-05944-00 #2	115792	
Brushes	29-10213	33308	3140-0267
Old Type Motor	29-12263 #2	115475	3162-0003
Brushes	29-12291	33309	3162-0004

Note #1. The Lamb Electric number is printed on each motor.

Note #2. These motors are interchangeable on the TU10, TU20, and TU30.

The Hewlett Packard numbers are supplied for your reference due to the fact that many parts carry their part numbers also.

When ordering brushes for replacement, be sure of the correct P/N needed by verifying the Lamb number on the motor against the brush number listed with that motor.

When ordering new motors, order P/N 12-05944-00 as P/N 29-12263 will be deleted from stock.

Title						MAG TAPE, TU20/TYPE TRANSPORTS REPLACEMENT PINCH ROLLERS		Tech Tip Number		TU20-TT-1	
All		Processor Applicability				Author		Rev		Cross Reference	
8's						Approval W. Cummins		Date 06-06-72			

When ordering replacement Pinch Roller assemblies for 580, TU20 or 545, you will be supplied with the type that are on the TU30. This roller is identical, except for a "lip" which will cause it to rotate continually when power is applied.

This feature improves start/stop timing, and reduces tape damage and end play problems of the roller and bearings. The 3030 rollers do work (field tested by Field Service). The .004" gap remains the same. Because of the superior characteristics of this roller, we are stocking only the 3030 Pinch Rollers.

CPL

Title						MAGNETIC TAPE UNIT TU20, TU20A		Tech Tip Number		TU20-TT-2	
All		Processor Applicability				Author		Rev		Cross Reference	
X						Approval W. Cummins		Date 06-06-72			

1. The drive function time program and specifications have been specified for a seven track system. These values are subject to change with a nine track drive due to head gap spacing. The revised specifications have been provided to Production Engineering and will be available soon.
2. TU20 manual specified rewind time as less than 3ms, should read 3 minutes.
3. The reason for supplying the read and write shutdown delay values in the TU20 specification and in PDP-8I Handbook, page 181 and 183, is to define the minimum time elapses, the drive begins to decelerate and will be given the necessary time to settle down (5 minutes).

NOTE: Continue mode of operation is allowable on the same drive even if a change of direction is given. The control automatically stops the drive and changes direction.

Title						TU20 Pulse Termination		Tech Tip Number		TU20-TT- 3	
All		Processor Applicability				Author Joe Godbout		Rev 0		Cross Reference	
X						Approval W. Cummins		Date 06-06-72			

It has been found that the optimum termination for the RECORD DATA pulse on the TU20, for a multiple transport system, would be one terminator on the first transport on the bus, and one terminator on the last transport on the bus. Currently each transport is equipped with the terminator.

In all future systems only the first and last transports on the bus will be terminated.

digital	FIELD SERVICE TECHNICAL MANUAL				CPI
					Option or Designator
	12 Bit <input checked="" type="checkbox"/>	16 Bit <input checked="" type="checkbox"/>	18 Bit <input checked="" type="checkbox"/>	36 Bit <input checked="" type="checkbox"/>	TU20

Title ADJUSTMENT OF G084 in TU20				Tech Tip Number	TU20-TT-4
All	Processor Applicability		Author	Rev	Cross Reference
X			Approval W. Cummins	Date 08/17/72	

New G084's may require adjustment in the field. G084 adjustment will be required in transports which have heads replaced.

DO NOT RETURN THESE MODULES TO THE PLANT.

DO NOT ADJUST THEM ACCORDING TO THE MAINTENANCE MANUAL.

1. Write a tape of all ones at 556 BPI, odd parity.
2. Look at pins on each G084 module.
3. Adjust each G084 output to 1.8 volts.
4. Run all applicable tests and check for errors.
5. Optimization may be necessary since the brand of tape will affect amplitude.

Title RECOMMENDED SPECIAL TOOLS TU20				Tech Tip Number	TU20-TT-5
All	Processor Applicability		Author	Rev	Cross Reference
X			Approval G.W. Morrison	Date 8-1-72	

Parts List

<u>Note</u>	<u>Dec. No.</u>	<u>Description</u>	<u>Quantity</u>
1	29-13479	Fitting, elbow	1
1	29-13480	Fitting, Tee	1
1	29-13481	Fitting, insert	1
1	29-12268	Gauge, vacuum 0-30" water	1
1	29-12868	Tubing, 1/4 inch I.D.	1
	29-12282	Shim.002, non magnetic	2
	29-19224	Alignment tape, 1200 feet	1
	29-15199	Transport cleaning kit	1
	29-16871	Tape developer	2
	29-15191	Markers EOT/BOT	2

Note¹: These items are required to complete a "kit" for most vacuum measurements. All items recommended as site tools.

COMPANY CONFIDENTIAL

Title TU20 READ/WRITE HEADS										Tech Tip Number TU20-TT-6		
All	Processor Applicability					Author G.W. Morrison			Rev 0		Cross Reference	
X						Approval Lou Nay		Date 9-29-72				

When ordering TU20 Read/Write Heads, use the applicable part number given below:

<u>DEC No.</u>	<u>Vendor No.</u>	<u>Description</u>
29-12541	CO4-13310A Opt 19	7-Track R/W head with tape cleaner
29-12590	CO1-13312A Opt 19	9-Track R/W head with tape cleaner

Note: Do not order any other part number for these R/W heads; all other sources are incorrect.

It is suggested that a copy of this Tech Tip be posted in all TU20 cabinets for future reference.

Title Proper Loading of Tape										Tech Tip Number TU20-TT-7		
All	Processor Applicability					Author Ken Bouchard			Rev g		Cross Reference	
X						Approval Lou Nay		Date 02/13/73				

On the TU20 there are two ways in which to load tape, that is to turn on vacuum and get the tape into the columns:

- (1) Push the "brakes" switch to the left or
- (2) Press the "load" button located at the top of the cabinet.

Method #1 not only loads the tape but also positions the crosstalk shield against the head, method #2 simply loads the tape.

Operators should be instructed to use method #1, the "brakes" switch, as read-after-write errors occur if the cross talk shield is not in place.

digital	FIELD SERVICE TECHNICAL MANUAL				Option or Designator
	12 Bit <input checked="" type="checkbox"/>	16 Bit <input checked="" type="checkbox"/>	18 Bit <input checked="" type="checkbox"/>	36 Bit <input checked="" type="checkbox"/>	TU20

Title ECO TU20-00022, G0870 Rev. C Module				Tech Tip Number TU20-TT-8	
All X	Processor Applicability			Author Lou Nay <i>LN</i>	Rev A
				Approval	Date 6-10-74
					Cross Reference TU30-TT-4

When installing ECO's TU20-00022 or TU30-00024 check the G0870 module supplied in the kit. If etch revision C, check for a jumper between the anode of D1 and resistor R6 as shown in the sketch below. If this jumper is not installed, do so before using the module.

If either of these ECO's have already been installed, check for the above condition.

An ECO is forthcoming creating a new etch (REV D) module and re-work instructions for the REV C boards.

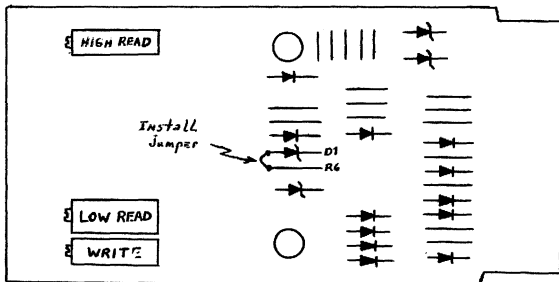

PRINTED IN USA

Title TU20 HEAD POLARITY						Tech Tip Number TT20-TT-9			
All X		Processor Applicability				Author F. DOLL		Rev n	Cross Reference
						Approval W. Freeman		Date 4 /3/74	

Some 9 track drives have been found to have their write head polarity reversed from other drives. This will only cause a problem if records are written by a drive which has one head polarity and additional records are written by a drive with the opposite polarity.

A false character is written when the write head is enabled by the second drive. Normally the write head will polarize the tape in the same direction as the erase head upon initial enabling creating no character on the tape unless the head polarity is incorrect. When the tape is read by either drive a record length or bad tape error will occur due to the one character.

The problem can be found by writing a few records on a drive, moving the tape to the second drive, reading the first two records and writing two additional records. When the third record is read by either drive a bad tape or record length error will occur.

To correct the problem reverse the wires between the head driver module and the connector card for all channels and erase head. Example:

Channel B/2	A02J-A01D	Delete
	A02K-A01E	Delete
	A02J-A01E	Add
	A02K-A01D	Add

Title Proper Part Numbers for Vacuum Motors & Brushes						Tech Tip Number TU20-TT-10			
All X		Processor Applicability				Author Jim Lingle		Rev	Cross Reference
						Approval Dick Odem		Date 10/4/74	TU10-TT-14

This Tech Tip generated for cross reference purposes.

digital	FIELD SERVICE TECHNICAL MANUAL				CPI. Option or Designator
	12 Bit <input checked="" type="checkbox"/>	16 Bit <input type="checkbox"/>	18 Bit <input checked="" type="checkbox"/>	36 Bit <input checked="" type="checkbox"/>	TU22 to TU25

Title TU22/25/28 INCREMENTAL MAG TAPE					Tech Tip Number TU22-TT-1	
All <input checked="" type="checkbox"/>	Processor Applicability			Author R. Vogelsang	Rev 0	Cross Reference
				Approval W. Cummins	Date 06-06-72	

On some units shipped prior to December 1969 no checking was done to determine whether or not the jumpers W2 and W3 on the FUNCTION CONTROL CARD (slot J203, schematic 100786, Section F15 of the PEC manual) were placed in the proper configuration, which is:

Jumper W2 in, Jumper W3 out.

As a result, when writing an END OF FILE, on some units an INTERRECORD GAP gets written preceding the END OF FILE. On a 9-channel unit this causes an unwanted CRC character (octal 327) with its associated LRC character being recorded on tape. On 7-channel units there is no such unwanted effect even with the jumper in the wrong position. Field units should be checked for this possible error.

Title INCOMPATIBILITY BETWEEN OLD AND NEW REVISION REEL SERVO BOARDS IN PEC TRANSPORTS					Tech Tip Number TU22-TT-2	
All <input type="checkbox"/>	Processor Applicability			Author Chuck Sweeney	Rev 0	Cross Reference
	8 8I 8L			Approval Frank Purcell	Date 07/31/72	

Title CAPSTAN MOTOR BRUSH WEAR (TU22/25/28)					Tech Tip Number TU22-TT-3	
All <input type="checkbox"/>	Processor Applicability			Author Chuck Sweeney	Rev 0	Cross Reference
	8 8			Approval Frank Purcell	Date 11/20/72	

The brushes used on the PEC 1000/2000 Series Incremental Tape Transports have a tendency to wear unevenly after prolonged periods of operation in a start/stop mode. A result of this wear can cause either or both of the following symptoms.

1. Incorrect spacing as regards the End of File and Inter-Record Gaps.
2. Random Parity Errors with no apparent logic failure

In either case, bit spacing is adversely affected. This condition can be remedied in the following manner:

- a. Remove power to transport (remove tape if one is mounted).
- b. Remove all PC boards (with the exception of J201, the Reel Servo Module) from the transport.

COMPANY CONFIDENTIAL

Title						CAPSTAN MOTOR BRUSH WEAR (TU22/25/28) (Cont)		Tech Tip Number		TU22-TT-3	
All		Processor Applicability				Author		C. Sweeney		Rev 0	
						Approval		F. Purcell		Date 11/20/72	
										Cross Reference	

- c. Carefully remove the two DC supply wires attached to the + and - posts on the Capstan Motor (note their positions for reassembly).
 - d. Run a wire from TP1 on J201 to the - terminal of the Capstan Motor.
 - e. Run another wire from TP2 of J201 to the + terminal of the Capstan Motor.
 - f. Apply power to the transport and allow Capstan to run for 2-3 hours.
 - g. Remove power from transports, remove wires between J201 and Capstan Motor.
 - i. Reconnect the two DC supply wires to their respective + and - terminals on the Capstan Motor (when securing these wires be certain the brush assemblies are firmly seated in the Capstan Motor housing).
- DO NOT OVER-TIGHTEN THESE NUTS
- j. Reinstall the modules that were removed in Step "b".
 - k. Remount the tape and apply power to the transport.

Prior to running any diagnostics, recheck the alignment of the following circuits: the Write Ramp generator, the Read Ramp generator, the EOF and IRG timing circuits.

Title						INCOMPATIBILITY BETWEEN OLD AND NEW REVISION REEL SERVO BOARDS IN PEC TRANSPORTS		Tech Tip Number		TU25-TT-1	
All		Processor Applicability				Author		Chuck Sweeney		Rev 0	
8		8I 8I				Approval		Frank Purcell		Date 07/31/72	
										Cross Reference TU28-TT-1	

Title						CAPSTAN MOTOR BRUSH WEAR (TU22/25/28)		Tech Tip Number		TU25-TT-2	
All		Processor Applicability				Author		Chuck Sweeney		Rev 0	
						Approval		F. Purcell		Date 11/20/72	
										Cross Reference TU27-TT-3	

COMPANY CONFIDENTIAL

COMPANY CONFIDENTIAL

digital	FIELD SERVICE TECHNICAL MANUAL				<i>CPL</i> Option or Designator
	12 Bit <input checked="" type="checkbox"/>	16 Bit <input type="checkbox"/>	18 Bit <input checked="" type="checkbox"/>	36 Bit <input checked="" type="checkbox"/>	TU28

Title Incompatibility Between Old and New Revision Reel Servo Boards in PEC Transports				Tech Tip Number TU28-TT-1		
All	Processor Applicability			Author C. Sweeney	Rev 0	Cross Reference
	8	8I	8L	Approval Frank Purcell	Date 07/31/72	

At present there are three different revision Reel Servo Boards in use. They are:

- a) 100129-01: Used on earlier module with potentiometer controlled tape tension arms; it cannot be used in place of the following boards:
- b) 100913-01: Used in later models with potentiometer controlled tape tension arms; it cannot be used on units with photo-sensing control of tape tension arms; it can be used as a replacement for the 100129-01 after the following wiring change on the PEC unit:

ADD: J201 pin 18 to J202 pin 20

- c) 100913-01E: Used on models with photo-sensing control of tape tension (it has two additional 100K OHM pots on it, set back from the +5V and -5V pots, for controlling the response of the photo amplifiers); it can be used as a replacement for (b) by setting the two 100K OHMs before installing the board; it can also be used in place of (a) by setting both 100K OHM pots to 5K OHMs and adding a jumper between J201 pin 18 and J202 pin 20.

Failure to follow the above directions when installing a revision 100913-01E in older transports may cause the Reel Servo amplifiers to be overdriven and fuse F201 to blow (SCR may also be damaged.) Once the pots have been adjusted to 5K OHMs, apply a coating of pot dope to set them.

This can be incorporated in the PDP-8/8I/8L Tech Tip Notebook.

Title CAPSTAN MOTOR BRUSH WEAR (Tu22/25/28)				Tech Tip Number TU28-TT-2		
All	Processor Applicability			Author C. Sweeney	Rev 0	Cross Reference TU22-TT-3
				Approval F. Purcell	Date 11/20/72	

-- NOTES --

digital	FIELD SERVICE TECHNICAL MANUAL				Option or Designator
	12 Bit <input checked="" type="checkbox"/>	16 Bit <input checked="" type="checkbox"/>	18 Bit <input checked="" type="checkbox"/>	36 Bit <input checked="" type="checkbox"/>	TU30

Title RECOMMENDED SPECIAL TOOLS FOR TU20 AND TU30				Tech Tip Number TU30-TT-1	
All	Processor Applicability		Author G. Morrison	Rev A	Cross Reference
X			Approval R. Yurick	Date 10/20/72	

This Tech Tip issued for cross reference purposes.

Title TU30 READ/WRITE HEADS				Tech Tip Number TU30-TT-2	
All	Processor Applicability		Author G.W. Morrison	Rev 0	Cross Reference
X			Approval Lou Nay	Date 9-29-72	

When ordering TU30 Read/Write heads, use the applicable part number given below:

<u>Dec. No.</u>	<u>Vendor No.</u>	<u>Description</u>
29-19161	HP#13312A Opt 20	TU30 9-track R/W head <u>without</u> tape cleaner
29-14371	HP#13310A Opt 20	TU30 7-track R/W head <u>without</u> tape cleaner

Note: Do not order any other part number for these R/W heads; all other sources are incorrect.

It is suggested that a copy of this Tech Tip be posted in all TU30 cabinets for future reference.

Title TU30 BALANCE SPRINGS				Tech Tip Number TU30-TT-3	
All	Processor Applicability		Author Lou Nay	Rev β	Cross Reference
X			Approval Lou Nay	Date 4-29-74	

Two styles of Balance Springs have been encountered in the field. Before ordering, determine which type you need by referencing the figures below.

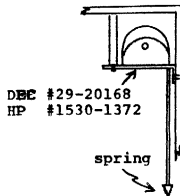
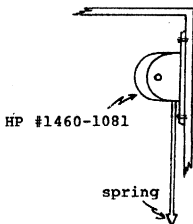

Title ECO TU30-00024, G0870 REV C MODULE						Tech Tip Number TU30-TT-4	
Processor Applicability						Author Lou Nay <i>LN</i>	
All						Rev 8	
X						Approval	
						Date	
						Cross Reference	
						TU20-TT-8	

When installing ECO TU30-00024 or if already installed, check the G0870 module. If ETCH REV. C see TU20-TT-8 for corrective action.

Title Proper Part Numbers for Vacuum Motors & Brushes						Tech Tip Number TU30-TT-5	
Processor Applicability						Author Jim Lingle	
All						Rev 8	
X						Approval Dick Odem	
						Date 10/4/74	
						Cross Reference	
						TU10-TT-14	

This Tech Tip generated for cross reference purposes.

PRINTED IN USA

digital	FIELD SERVICE TECHNICAL MANUAL				Option or Designator
	12 Bit <input type="checkbox"/>	16 Bit <input checked="" type="checkbox"/>	18 Bit <input type="checkbox"/>	36 Bit <input checked="" type="checkbox"/>	TU55

Title				Tech Tip	
Compatability TU55's				Number TU55-TT-1	
All 8's	Processor Applicability		Author E. Luttig	Rev 0	Cross Reference
			Approval W. Cummins	Date 6/7/72	

A. Write enable compatability with TU55's.

There are approximately one hundred and fifty (150) TU56's in the field containing the "B" revision "Switch Control Panel" (assembly 70-06222). Transports containing these control panels will have difficulty enabling the "Write" function if connection in any of the following system configurations.

1. A TC01 or TC02 control, a TU56 w/B Rev. Switch Control Panels and more than two (2) TU55's.
2. A TC01 or TC02 control, a TU56 w/B Rev. Switch Control Panels and more than one additional TU56 w/C Rev. Switch Panels.
3. An additional problem will be generated if the R107 modules in slot B11 of the TU55's have been replaced by S107 modules in which case a TU56 w/B Rev. Switch Control Panels will not operate reliably in conjunction with any TU55's.

If any of these circumstances occur the problem may be resolved by replacing Rev. B panels by Rev. C Panels.

NOTE: C Revision panels are direct replacements for B revision panels.

/mt

COMPANY CONFIDENTIAL

Title					TU55 INFORMATION					Tech Tip Number		TU55-TT-2	
All		Processor Applicability			Author			Rev 0		Cross Reference			
					Approval W. Cummins			Date 6/6/72					

Problem: When a TU55 is set to unit 8 (\emptyset) tape creep is evident when other transports in the system are being used. Tape creeps about 3/4" per hour running DECTREX on one (1) other transport, TU56 or TU55. This problem has been observed only on TC \emptyset 8 controller.

Cause: When Status A or the TC \emptyset 8 changes value, under program control, unit \emptyset is selected momentarily causing the select line for unit \emptyset (8) to "glitch". This glitch appears at the two And gates, at location B \emptyset 6 in the TU55, and is Anded with the Forward (FDW) and reverse (REV) signals causing the Direction F/F at B \emptyset 8 to toggle as the FWD/REV bit in the Status A register is changing.

Because direction is toggling and Brake Enable is true and delay (\emptyset) is true, the two solenoid drivers at B12R and S cause the left and right brakes to toggle. Because there is uneven tape tension, the tape creeps as the brakes are turned on and off.

Fix: Install a D664 diode as follows:

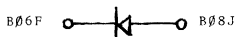

This diode prevents the Direction F/F from changing states when Motion (\emptyset) is true.

This fix in no way hampers operation of the manual switches that wind or rewind tape.

This can be incorporated in the PDP-8/SI/SL Tech Tip Notebook

COMPANY CONFIDENTIAL

digital	FIELD SERVICE TECHNICAL MANUAL				Option or Designator
	12 Bit <input checked="" type="checkbox"/>	16 Bit <input checked="" type="checkbox"/>	18 Bit <input checked="" type="checkbox"/>	36 Bit <input checked="" type="checkbox"/>	TU55

Title	TU55 TAPE GUIDE REPLACEMENT			Tech Tip Number	TU55-TT-3
All	Processor Applicability		Author	Rev	Cross Reference
			Approval W. Cummins	Date 6/6/72	

In Dectape installations which require above average usage, there may be a problem of aluminum from the guides adhering to the tape. The correct procedure for replacing the aluminum guides with an optional, heavy duty, type is as follows:

- 1) Remove all power from the transport.
- 2) Place a protective covering over the head to eliminate any possibility of its being damaged.
- 3) Remove the two hex head screws from the front of each guide and remove the front cover plate assembly.
- 4) Remove the four hex head screws which hold the transport mounting plate in position. Move the transport assembly forward about two inches so that the two hex head screws which secure the guides to the mounting plate can be removed. These screws are accessible from above.
- 5) Each guide is now held to the mounting plate by two roll pins which can be seen from the rear; with a pin punch, drive the pins and guide evenly forward to dismount the guide.
- 6) Check the front surface of the mounting plate where the pins were driven through to be certain that no burring or protrusion of the surface around the holes has occurred. A stone should be used to eliminate any protruding distortion of the surface.
- 7) With pliers, pull the pins from the original guide.
- 8) The pins should then be inserted into the new guide, the mating surfaces cleaned, and the guide positioned against the mounting plate with the pins aligned with the holes. With a non-metallic hammer and/or a protective block of wood or plastic, gently tap the guide evenly so as to begin insertion of the pins evenly into their holes. The screw which is to secure the guide to the plate should be engaged and tightened alternately as the guide is tapped to maintain alignment with the plate as the guide is seated.
- 9) As the screw is finally tightened, there should be no gap between the plate and the guide.
- 10) Replacement of the front cover plate assembly will complete the exchange.
- 11) It is advisable that skew be checked if equipment is available, otherwise a formatting/exercise exchange of tapes between transports will be indicative.

COMPANY CONFIDENTIAL

Title						TU55 "SET UP" SPECIFICATION AND PROCEDURES		Tech Tip Number		TU55-TT-4	
All		Processor Applicability				Author		Rev		Cross Reference	
						Approval W. Cummins		Date 6/6/72			

TU55 "SET UP" SPECIFICATIONS AND PROCEDURES

- 1) Set brake disk-brake coil gap at .004 in. clearance; a single thickness of ASR-33 paper makes an adequate "gauge". Surfaces should be parallel, however, the .004 in. is to be measured where the surfaces are closest when minor disk distortion is present.
- 2) Torque settings (equally valid for 50 and 60 HZ)
 - a) Initial conditions
 - 1) Line voltage at AC receptacle on TU55 = 115 VAC
 - 2) Tape on both reels
 - 3) Brake gap set as described above
 - b) Stop Torque set up
 - 1) Connect VOM to tabs of G850 in slot A12 (right motor) (expect ± 60 VAC)
 - 2) Switch unit to "LOCAL"
 - 3) Push FWD, \rightarrow switch and release
 - 4) Adjust pot nearer the G850 handle for meter reading of 60 VAC
 - 5) Connect VOM to tabs of G850 in slot A11 (left motor)
 - 6) Push REV, \leftarrow switch and release
 - 7) Adjust as in step 4 above
 - c) Trailing Torque set up
 - 1) Connect VOM to tabs of G850 in slot A12 (right motor) (expect ± 85 VAC)
 - 2) Rewind tape so that right reel is nearly full of tape.
 - 3) Push and hold the REV, \leftarrow switch so tape is winding onto the left reel as this adjustment is made.
 - 4) Adjust pot farther from the G850 handle for meter reading of 85 VAC.
 - 5) Connect VOM to tabs of G850 in slot A11 (left motor).
 - 6) Rewind tape so that left reel is nearly full of tape.
 - 7) Push and hold the FWD, \rightarrow switch so tape is winding onto the right reel as this adjustment is made.
 - 8) Adjust pot farther from the G850 handle for meter reading of 85 VAC.
 - d) Stop Delay set up
 - 1) Switch unit to "LOCAL"
 - 2) Scope voltage at pin A04D
 - 3) Press and release FWD, \rightarrow switch
 - 4) Adjust pot on R303 delay for 80 ms. which is the spec.

COMPANY CONFIDENTIAL

CPL

digital	FIELD SERVICE TECHNICAL MANUAL				Option or Designator
	12 Bit <input checked="" type="checkbox"/>	16 Bit <input checked="" type="checkbox"/>	18 Bit <input checked="" type="checkbox"/>	36 Bit <input checked="" type="checkbox"/>	TU55
Title	TU55 SKEW PROBLEMS CAUSED BY TAPE GUIDES			Tech Tip Number	TU55-TT-5
All	Processor Applicability	Author	Rev	Cross Reference	
x		Approval H. Long	Date 08.17.72		

It has been found that a batch of incomplete rear cheek plates got into the shelves of our Field Service Stockroom. These plates do not have the lower outside edge beveled. Also all the corners are pretty sharp which is bad in particular at the points where the tape runs onto the plate.

Be sure to check your local supplies and discard or return to Maynard Field Service stockroom any improper plates with the necessary comment.

If any of the unbeveled cheek plates or any plates with burrs are installed they will cause excessive tape flutter and skew.

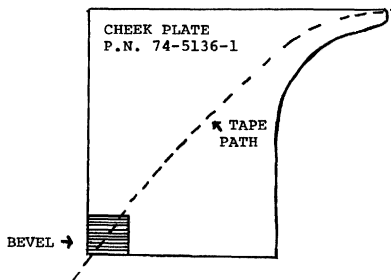

Title	ADJUSTMENTS FOR DECTAPE SYSTEMS - Family of 8			Tech Tip Number	TU55-TT-6
All	Processor Applicability	Author	Rev	Cross Reference	
		Robert Nunley	0	CPL	
		Approval Frank Purcell	Date 12/06/72	TU56-TT-9	

COMPANY CONFIDENTIAL

Title										Tech Tip		
PROBLEM WITH TC01-TU55 DECTAPE FORMATTER										Number		
Processor Applicability										TU55-TT-7		
All										Author	Rev	Cross Reference
8's										K. Wunderlich	g	
Approval										Date		TC01-TT-4
B. Hansen										2/6/74		

Title										Tech Tip		
TU55/56 SPIDER HUB VARIATIONS										Number		
Processor Applicability										TU55-TT-8		
All										Author	Rev	Cross Reference
X										Sweeney/Newbery	0	
Approval										Date		TU56-TT-13
R. Boehm										4-5-74		

This Tech Tip is issued for Cross Reference Purposes.

Title										Tech Tip		
TU55 CONFIGURATION WITH TC01/550/552										Number		
Processor Applicability										TU55-TT-9		
All										Author	Rev	Cross Reference
X										W. Freeman	g	
Approval										Date		
W. Cummins										12/12/73		

The following chart indicates differences which must be resolved when a TU55 is removed from a 550 or 552 and installed on a TC01 or vice versa.

	TC01	550	552
TU55 slot B7 contains	W990*	W513	W513
TU55 -A6K to A9S	100 ohm terminator	None	None
*Jumpers on W990 connect the following pairs of terminals:			
DE - FH - JK - LM - NP - RS - UV			

digital	FIELD SERVICE TECHNICAL MANUAL				Option or Designator
	12 Bit <input checked="" type="checkbox"/>	16 Bit <input checked="" type="checkbox"/>	18 Bit <input checked="" type="checkbox"/>	36 Bit <input checked="" type="checkbox"/>	TU56

Title TU56 Motors - Vendor Compatability				Tech Tip Number TU56-TT-1	
All	Processor Applicability		Author Harry Drab	Rev A	Cross Reference
			Approval	Date May 1973	

There are several vendors for TU56 motors at this time. All of them produce acceptable motors, but it should be noted that it is not recommended to mix vendors within a drive because no detailed engineering analysis has been done to determine any possible side effects. All approved vendor motors meet our purchase specs and are therefore within 10% of each other. This means that the same vendor should supply the motors driving the two hubs for a given head, but is is permissible for example to have two Elinco motors on one drive and two Ashland motors on the other drive within the same TU56.

To identify the different vendors, see the attached drawings of the rear of the motors, and the descriptions below.

Ashland - Initially supplied 50 evaluation units which were BAD. The problem was mechanical vibration induced by the 40 cycle drive waveform from the G848. None of these fifty should have reached the field, but if they do, they can be recognized by a front plate (the one with the shaft sticking through) that looks like the Elinco end plate, minus the four kidney shaped holes round the center. Ashland have since fixed the problem and are now supplying good motors which are now commonly used in production.

EAD Eastern Air Devices have always been good, and were our commonest production source for the last few quarters.

ELINCO Always been good, although they are not currently being used in production.

MOTRONICS Have been approved as a vendor, but have not yet supplied production units.

COMPANY CONFIDENTIAL

Title						Tech Tip	
TU56 Motors - Vendor Compatability						Number	
Processor Applicability						TU56-TT-1	
All					Author	Rev	Cross Reference
X					Harry Drab	A	
					Approval	Date	
						May 1973	

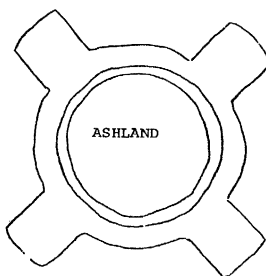
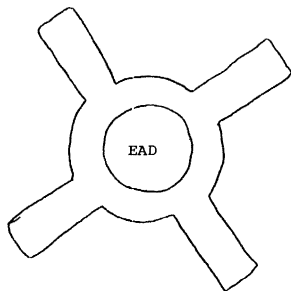
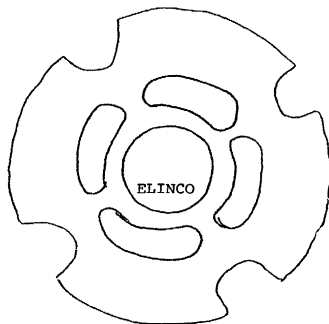
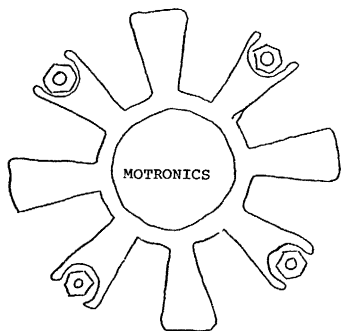

PAGE 750	PAGE REVISION	PUBLICATION DATE
----------	---------------	------------------

COMPANY CONFIDENTIAL

digital	FIELD SERVICE TECHNICAL MANUAL				Option or Designator
	12 Bit <input checked="" type="checkbox"/>	16 Bit <input checked="" type="checkbox"/>	18 Bit <input checked="" type="checkbox"/>	36 Bit <input checked="" type="checkbox"/>	TU56 - TT-2

Title TU56 SWITCH FAILURES				Tech Tip Number		
All	Processor Applicability			Author Derek Oldham	Rev 0	Cross Reference
X				Approval Harold Long	Date 6/6/72	

Problem "Write Enable" switches failing soon after installation.
Correction: Clean the switches with freon or isopropyl alcohol.

Title G847 MODULE --- ECO #6				Tech Tip Number TU56-TT-3		
All	Processor Applicability			Author Harry Drab	Rev 0	Cross Reference
X				Approval Bill Cummins	Date 06/1/72	

The transistors called out in the module ECO referenced above have two (2) possible pin configurations and can be inserted backwards.

The transistors in question are DEC part numbers 151Ø7Ø5 and 151Ø7Ø6. The two (2) presently accepted sources are Motorola (MPSAØ5 and MPSA55, respectively), and General Electric (GPSAØ5 and GPSA55, again, respectively). The pin configurations for the Motorola and G.E. transistors are shown at the end of this memo. Note that the flattened part of the transistor cannot be used as a reference when the transistor is inserted.



COMPANY CONFIDENTIAL

Title TU56 INTERMITTENT ERRORS							Tech Tip Number TU56-TT- 4		
All	Processor Applicability						Author B. Nunley	Rev 0	Cross Reference
	8	8I	8E	8L	11	12	Approval W. Cummins	Date 6/6/72	

There are numerous reports of intermittent errors (timing, mark track, parity or data) on TU56. The resultant investigation led to numerous possibilities for the cause of these errors. Not every TU56 exhibits the errors at this time, but the potential is present for all of them. The most probable cause is poor grounding technique. Grounds are made through painted surfaces and mechanical mountings. This Tech Tip will give temporary methods to cure the problems until ECO's are generated.

Do things in this order:

- 1) Clean guides and head. Disassemble the guides and clean the wear plate, its spring and their respective slots. Check for correct assembly of wear plate and spring.
- 2) Make sure all electrical adjustments are set correctly.
- 3) Ground the front panel by running a 30 gauge terminal jumper from pin C2 in an unused slot in the B row, to one of the screws holding the slide to the right side of the front panel.

These three steps should cure the random problems; however, there is the final step if they did not:

- 1) Remove the TU56 from the cabinet.
- 2) Remove the G848 modules and cut the etch going to pin AC2 and to pin BC2.
- 3) Run a jumper from a common point of the two capacitors in the 725 to the ground lug on the back of the 725 power supply where the logic power comes in.
- 4) Remove one screw from each surface on the power supply and scrape the paint from under it, then replace the screw tightly. Do this also for the AC recepticals on the 725.

If the problem persists, you probably have a skew problem which must be corrected by deskewing the guides or the head or both.

COMPANY CONFIDENTIAL

digital	FIELD SERVICE TECHNICAL MANUAL				Option or Designator
	12 Bit <input type="checkbox"/>	16 Bit <input checked="" type="checkbox"/>	18 Bit <input checked="" type="checkbox"/>	36 Bit <input checked="" type="checkbox"/>	TU56

Title TU56 INTERMITTENT ERROR (Continued)				Tech Tip Number TU56-TT-4				
All	Processor Applicability			Author Robert Nunley	Rev 0	Cross Reference		
	8	8E	8I	8L	15		11	12

Motor slow to come up to speed:

If you have a motor which seems to have a slow dirve in one direction, the cause may not be a bad motor. This motor exerts a force of about 60 inch/ounces, therefore any undue binding because of misalignment of hubs and guides can cause the motor to appear to be bad. To check, run a full reel of tape onto the forward reel watching the inside edges of the spool to see that there is some clearance between the spool interior sides and the tape edges. If this clearance is not present, the tape will ride up one side or the other, indicating a misalignment which can cause the drag. Do the same in the reverse direction. If, in either direction, there is the build up on the edge remove that hub and adjust it so that there is clearance between the tape and spools.

For information only:

The drag may also be caused by the bushings or spring mounted on the motor shaft. These bushings are there to give a balancing drag and to prevent the tape from creeping to the full reel when no motion is ordered either in local or remote. The bushings are oil impregnated and no cleaning of them should be attempted. If after all else fails to eliminate the slow motor and you feel you must replace the motor also replace the bushings and spring. So with each motor (12-9602) order also the following:

Bushing 12-9926 2 each
Spring 12-9917 1 each
Connector Pins 12-9370 4 each

Also check for loose connections in the motor mate-n-lock connectors.

Title DECTAPE TRANSPORT CABLES				Tech Tip Number TU56-TT-5		
All	Processor Applicability			Author C. Sweeney	Rev 0	Cross Reference TC08-TT-3
	8I	8L	8E	Approval W. Cummins	Date 6/6/72	

Title Compatability TU55's				Tech Tip Number TU56-TT- 6		
All X	Processor Applicability			Author E. Luttig	Rev 0	Cross Reference TU55-TT-1
				Approval W. Cummins	Date 6/7/72	

Title						TU56 PROBLEMS		Tech Tip Number		TU56-TT-7	
All						Processor Applicability		Author		Rev 0	
X								Approval		Date 08/08/72	
										Cross Reference	

Investigating the following four areas can save you much time when investigating problem reports involving slow turn around and/or up to speed discrepancies.

A. Dry bushings in anti-creep clutch.

1. The bushings, part number 12-09926, are ordered as oil impregnated. In the past one order of bushings was received which were plain brass, not oil impregnated. It appears that a few (approx. 100) of these were installed in TU56's before the error was caught. These plain brass bushings are easy to spot.

- a. They will not have any oily film on their surface.
- b. In appearance they will be very shiny and will have grooves worn into the surface of the bushing that contacts the hub.

2. Solution: Replace with new bushings which are oil impregnated. The new oil impregnated bushing will have many small black pits in its surface.

B. Incorrect size of springs (DEC Part Number 12-09917) used in the anti-creep clutch.

1. The easy way to check for this problem is to first make sure that both bushings in the anti-creep clutch assembly are oil impregnated.
 - a. With the anti-creep clutch installed and the hub correctly installed (use gauge) put the Remote-Local-Off switch to the Local position allowing motor time to get up to speed and then turn switch to "Off". If the hub comes to an abrupt stop, less than two revolutions, you may have an oversize spring. The part of the spring that is most critical is the tip that fits into the lock ring in the mounting surface of the motor. If you do not have a new spring it is possible to bend this tip slightly, effectively reducing its length. Do not attempt to bend the spring material too much as it will fracture.

C. Hub Set Screws

1. If, for any reason, you remove a plastic reel hub from a DECTape transport replace the set screws with new ones and be sure that the set screws are DEC Part #90-08382-10. NO OTHER TYPE WILL CORRECTLY HOLD THE HUB!

COMPANY CONFIDENTIAL

digital	FIELD SERVICE TECHNICAL MANUAL				Option or Designator
	12 Bit <input checked="" type="checkbox"/>	16 Bit <input checked="" type="checkbox"/>	18 Bit <input checked="" type="checkbox"/>	36 Bit <input checked="" type="checkbox"/>	TU56

Title TU56 PROBLEMS (Continued)				Tech Tip Number	TU56-TT-7
All	Processor Applicability			Author	Rev 0
X				Approval H. Long	Date 08/08/72
					Cross Reference

D. M307 Instability

1. The M307 one shot module is rate sensitive when set to its shortest time constant range. This can cause a sufficient "rate delay" or "up to speed" error to cause the DECTape to miss a block. In severe cases the system can oscillate back and forth past the block for which it is searching without ever finding it. Check your control and see if this module is used and checks its operation.
 - a. A quick way to resolve this problem is to set the M307 to the second range and readjust for the correct one shot timing.

Summary

Corrective action has been taken to eliminate all of the above problem possibilities. However, you should investigate your unit with the thought in mind that your problem unit may have been made before the corrections were made.

COMPANY CONFIDENTIAL

Title						INTERMITTENT ERRORS ON TU56		Tech Tip Number		TU56-TT-8	
All		Processor Applicability				Author		Rev		0	
X						Approval		Date		10/18/72	
						W. Cummins				Cross Reference	

There are numerous reports of intermittent errors (timing, mark track, parity or data) on TU56. The resultant investigation led to numerous possibilities for the cause of these errors. Not every TU56 exhibits the errors at this time, but the potential is present for all of them. The most probable cause is poor grounding technique. Grounds are made through painted surfaces and mechanical mountings. This Tech Tip will give temporary methods to cure the problems until ECO's are generated.

Do the following procedure in this order:

1. Clean guides and head. Disassemble the guides and clean the wear plate, its spring and their respective slots. Check for correct assembly of wear plate and spring.
2. Make sure all electrical adjustments are set correctly.
3. Ground the front panel by running a 30 guage termipoint jumper from pin C2 in an unused slot in the B row, to one of the screws holding the slide to the right side of the front panel.

These three steps should cure the random problems, however, there is the final step if they did not:

1. Remove the TU56 from the cabinet.
2. Remove the G848 modules and cut the etch going to pin AC2 and pin BC2.
3. Run a jumper from a common point of the two capacitors in the 725 to the ground lug on the back of the 725 power supply where the logic power comes in.
4. Remove one screw from each surface on the power supply and scrape the paint from under it, then replace the screw tightly. Do this for the AC receptacles on the 725.

If the problem persists you probably have a skew problem which must be corrected by deskewing the guides or the head or both.

Motor slow to come up to speed:

If you have a motor which seems to have a slow drive in one direction, the cause may not be a bad motor. This motor exerts a force of about 60 inch/ounces, therefore, an undue binding, because of misalignment of hubs and guides can cause the motor to appear to be bad. To check, run a full reel of tape onto the forward reel watching the inside edges of the spool to see that there is some clearance between the spool interior sides and the tape edges. If this clearance is not present, the tape will ride up one side or the other, indicating a misalignment which can cause

COMPANY CONFIDENTIAL

GENERAL EQUIPMENT CORPORATION

digital	FIELD SERVICE TECHNICAL MANUAL				Option or Designator TU56
	12 Bit <input checked="" type="checkbox"/>	16 Bit <input checked="" type="checkbox"/>	18 Bit <input checked="" type="checkbox"/>	36 Bit <input checked="" type="checkbox"/>	

Title INTERMITTENT ERRORS ON TU56 (Continued)				Tech Tip Number TU56-TT-8		
All X	Processor Applicability			Author	Rev 0	Cross Reference
				Approval W. Cummins	Date 10/18/72	

the drag. Do the same in the reverse direction. If, in either direction there is the build up on the edge, remove that hub and adjust it so that there is clearance between the tape and spools.

For information only; the drag may also be caused by the bushings or spring mounted on the motor shaft. These bushings are there to give a balancing drag and to prevent the tape from creeping to the full reel when no motion is ordered either in local or remote. The bushings are oil impregnated and no cleaning of them should be attempted. If after all else fails to eliminate the slow motor and you feel you must replace the motor also replace the bushings and spring. So with each motor (12-9602) order also the following:

Bushing 12-9926 - 2 each
Spring 12-9917 - 1 each
Connector Pins
12-9370 - 4 each

Also check for loose connection in the motor mate-n-lock connectors.

COMPANY CONFIDENTIAL

NOTES

digital	FIELD SERVICE TECHNICAL MANUAL				Option or Designator
	12 Bit <input checked="" type="checkbox"/>	16 Bit <input checked="" type="checkbox"/>	18 Bit <input checked="" type="checkbox"/>	36 Bit <input checked="" type="checkbox"/>	TU56

Title ADJUSTMENTS FOR DECTAPE SYSTEMS - FAMILY OF 8				Tech Tip Number TU56-TT-9	
All	Processor Applicability		Author R. Nunley	Rev g	Cross Reference
			Approval F. Purcell	Date 12/06/72	

ADJUSTMENTS FOR DECTAPE SYSTEMS

There are several various sources of adjustment procedures for DECTape some of each of which are incorrect. To correct the deficiencies, this paper is a consolidation and condensation of the various sources and has as its objective to establish procedure and value for the different delays and oscillators.

Listed in the outline are different adjustments, the procedure to adjust, the value to adjust to, test points and pot/module location. Tools necessary:

454 oscilloscope or equivalent = (scope)
 Volt-OHN-Ammeter = (VOH)
 Pot Tweaker
 24 gauge termipoint jumper - TC01
 30 gauge termipoint jumper - TC08

At least 1 known good certified or formatted reel of certified DECTape (supplied by customer).

1 set of Allen Wrenches

Programs:

#1

0000	1224	TAD 24
0001	6766	DTCA DTXA
0002	7300	CLACLL
0003	1023	TAD 23
0004	3020	DCA 20
0005	2021	ISZ 21
0006	5005	JMP.-1
0007	2020	ISZ 20
0010	5005	JMP.-3
0011	1025	TAD 25
0012	6764	DTXA
0013	5002	JMP. BEG +2
0020	0000	
0021	0000	
0022	0000	
0023	7700	Wait loop about 1.2 sec.
0024	0000	Unit 0, move forward
0025	0000	Change direction each DTXA

COMPANY CONFIDENTIAL

Title ADJUSTMENTS FOR DECTAPE SYSTEMS - Family of 8 (Continued)						Tech Tip Number TU56-TT-9		
All Processor Applicability						Author R. Nunley Rev g		Cross Reference
						Approval F. Purcell Date 12/06/72		

Programs (continued)

#2

0030	1237	TAD 37
0031	6764	DTXA
0032	7000	NOP
0033	7000	NOP
0034	7000	NOP
0035	7200	CLA
0036	5230	JMP 30
0037	0400	Unit 0, Reverse, HALT.

TRANSPORTS ADJUSTMENTS TU55:	PROCEDURE	VALUE
Brake Disk Gap	Power off. Brake gap is set by loosening the set screws in the hub of the disk and spacing the disk from the braking surface (on the motor)	The gap should be about .004 inches (one thickness of TTY paper). Disk should fly parallel to the brake surface.
Brake Oneshot	Power on. Local. Equal tape on each reel. Forward or reverse switch rapidly pushed or released. SCOPE.	TP. - A4D Nominal 80 msec. Pot R303 AB4.
Drag & Stop Torque Voltage	Local. Equal tape on each reel. Connect black lead from meter to red AC input faston connector on back of TU55 (above motor). Right motor - connect red lead from meter to faston tab of cap below right motor (as viewed from the front). Do drag and stop adjustment for right motor before moving the red lead. Left motor - connect red lead from meter to faston tabs on cap below left motor (as viewed from the front). Do drag and stop adjustment before removing leads. Caution should be taken not to connect meter leads to the G850's for they are easily shorted and destroyed.	Right: Connect meter as described. Power on. Stop: Push and Release → FWD Push button. Adjust pot nearest the handle on G850 in A12 for 60 VAC. Drag: Push Hold (REV) ← Pushbutton, adjusting pot farthest from the module handle on G850 in A12 for 85V AC. Power Off: Connect leads for left motor. Power on left. Push and Release (REV) ← pushbutton, ADJ pot nearest the handle of G850 in A11 for 60 VAC.

COMPANY CONFIDENTIAL

DIGITAL EQUIPMENT CORPORATION

digital	FIELD SERVICE TECHNICAL MANUAL				Option or Designator
	12 Bit <input checked="" type="checkbox"/>	16 Bit <input checked="" type="checkbox"/>	18 Bit <input checked="" type="checkbox"/>	36 Bit <input checked="" type="checkbox"/>	TU56

Title ADJUSTMENTS FOR DECTAPE SYSTEMS - FAMILY OF 8 (Continued)				Tech Tip TU56-TT-9 Number	
All	Processor Applicability		Author R. Nunley	Rev 0	Cross Reference
			Approval F. Purcell	Date 12/06/72	

ADJUSTMENTS FOR DECTAPE SYSTEMS (Continued)

TRANSPORTS ADJUSTMENTS TU55:	PROCEDURE	VALUE
Drag & Stop Torque Voltage (continued)	<p>Power ON. Local. Actuate in turn forward and REV. Pushbutton, tape should run freely in each direction and stop with no backlash or slapping. If any slapping is in evidence, the brake oneshot may be fine tuned to remove the slap.</p>	<p>Drag: Push and hold → (FWD). Pushbutton adjusting pot furthest from the handle on G850 in A11 85V AC. Power OFF. Remove meter leads.</p>
TRANSPORTS ADJUSTMENTS TU56:	PROCEDURE	VALUE
Brake Oneshot	<p>Power ON. Equal tape on each reel. Local - Rapidly push & release FWD or REV push-buttons. Scope.Fine adjust so there is no tape slap.</p>	<p>M3#2 B#8 Left transport, TP, B08F2 top pot. Right transport TP B08T2, bottom pot. Nominal 85 msec.</p>
40 Hz Oscillator	<p>Scope. Power ON.</p>	<p>A03 M2 or A03 N2 Adjust oscillator for 25 msec (40 Hz)</p>
HUBS	<p>Hubs are to be positioned so that there is .#17 inches clearance between back of hub and shaft channel in mounting plate. The set screws are to be adjusted to 18 inches/ounces. However the gauge and torque wrench necessary for hub adjustment are not always available, so the following is the procedure:</p>	

Title ADJUSTMENTS FOR DECTAPE SYSTEMS - FAMILY OF 8 (cont)						Tech Tip Number	TU56-TT-9			
All	Processor Applicability					Author	R. Nunley	Rev	0	Cross Reference
						Approva	P. Purcell	Date	12/06/72	

ADJUSTMENTS FOR DECTAPE SYSTEMS (Continued)

TRANSPORTS ADJUSTMENTS (TU56)	PROCEDURE	VALUE
HUBS (continued)	<p>In lieu of .#17 guage:</p> <p>Position hub so that there is no tape pile up on either wall of the reel when tape is wound onto that reel. Hub should fly parallel to the front panel with no wobble.</p> <p>In lieu of Torque wrench:</p> <p>Adjust set screws only with a free Allen wrench (not the type which folds into a knife case - like handle or ones which have screw driver handle) This limits the amount of mechanical advantage but allows the set screw to be torqued enough to sufficiently set the screw. CAUTION: The serrated cup of the set screw (DEC #90-8382-10) is soft and will become smooth after several tighten-loosen cycles and must be replaced.</p> <p>Toggle in Programs</p>	

COMPANY CONFIDENTIAL

DIGITAL EQUIPMENT CORPORATION

digital	FIELD SERVICE TECHNICAL MANUAL				Option or Designator
	12 Bit <input checked="" type="checkbox"/>	16 Bit <input checked="" type="checkbox"/>	18 Bit <input checked="" type="checkbox"/>	36 Bit <input checked="" type="checkbox"/>	TU56

Title ADJUSTMENTS FOR DECTAPE SYSTEMS - Family of 8 (Continued)				Tech Tip Number	TU56-TT-9
All	Processor Applicability	Author	Rev	Cross Reference	
		Robert Nunley	0		
		Approval Frank Purcell	Date	12/06/72	

ADJUSTMENTS	PROCEDURE	TC#1	TC#8
TPO Crosstalk Delay	Toggle in Programs Scope. Transport remote, Unit 0, equal tape on each reel. Tape has to be either certified or formatted Load Start 0000.	DTE20M. ADJ top pot, R302DTE 20 for 10 μ sec. Positive going square wave.	A14F2. ADJ top pot M302 A14 for 10 μ sec. Positive going square wave.
TPI Crosstalk Delay	Same as TPO. Halt Computer	None	A14T2. ADJ bottom pot M302 A14 for 10 μ sec Positive going square wave.
Unit & Motion Delay	Scope. Transport Remote, Unit 0, equal tape on each reel. Tape must be either certified or formatted. Load and start 0000.	DTE25D. ADJ R303 DTE25 for 120 msec positive going square wave.	D14E2. ADJ top pot M307 D14 for 140 msec. Negative going square wave.
Rate Delay (TC01)	As in U & M Delay. Halt computer.	DTE15E. ADJ Pot M303 DTE15 for 70 μ sec positive going square wave.	
Speed Delay (TC08)	Remove G888 from A18. Termpoint jumper between D14K2 & D14U1. Transport, remote, unit 0. Run program #2. Restore TC08 when finished.		D14F2. Adjust bottom pot. M307 D14 for 70 μ sec. Negative going square wave.
XSA Delay	Transport remote unit 0. Load start 0030, program #2.	DTE20V ADJ Bottom pot. R302 DFE20 for 5 μ sec. Negative going square wave.	With ECO TC08-0021 D16T2. Bottom pot. ADJ M302 D16 for 3 μ sec.

COMPANY CONFIDENTIAL

Title ADJUSTMENTS FOR DECTAPE SYSTEMS - Family of 8 (Continued)						Tech Tip Number	TU56-TT-9			
All	Processor Applicability					Author	Robert Nunley	Rev	0	Cross Reference
						Approval	Frank Purcell	Date	12/06/72	

ADJUSTMENTS	PROCEDURE	TC01	TC08
XSA Delay (con't)			Without ECO TC08-0021 D16T2. Bottom Pot adjust M302 D16 as follows: PDP8-I 6.5 μ sec PDP8-E 6.5 μ sec PDP8-L 7.0 μ sec PDP8 6.5 μ sec Positive square.
Write Clock	HALT COMPUTER Scope. 24 Gauge termipoint jumper - TC01 30 gauge termipoint jumper - TC08 transport local. No tape over head. Computer halted.	Jumper between ground and DTD22P. TP. DTC25D. ADJ pot R401 DTC25 for 8.33 sec. Pulse repition rate. (120 KHz) Remove jumper.	Jumper between ground and D15K2 TP. D15D2 ADJ pot M401 D15 for 8.33 sec (120 KHz). Pulse repition rate. Remove jumper.
SYNC-PL Delay (TC08)	Make following changes to program 1: 0024= 0310-Unit 0, FWD, search. Continous. 7754=WC=0000 7755=CA=0177' Transport, Remote, Unit 0, equal tape on each reel. Tape must be either certified or formatted. Load and Start 0000. Scope. HALT COMPUTER	None	TP D16F2. ADJ top pot M302, D16 for .2 μ sec. Positive going square wave. (This ADJ added by ECO TC08- 00018).

COMPANY CONFIDENTIAL

DIGITAL EQUIPMENT CORPORATION

digital	FIELD SERVICE TECHNICAL MANUAL				Option or Designator
	12 Bit <input checked="" type="checkbox"/>	16 Bit <input checked="" type="checkbox"/>	18 Bit <input checked="" type="checkbox"/>	36 Bit <input checked="" type="checkbox"/>	TU56

Title ADJUSTMENTS FOR DECTAPE SYSTEMS - FAMILY OF 8 (Continued)				Tech Tip Number TU56-TT-9	
All Processor Applicability				Author Robert Nunley Rev 0	
				Approval Frank Purcell Date 12/06/72	
				Cross Reference	

At this time all adjustments have been made. Scratch tapes should now be formatted and Basic Exerciser parts 201, 203, 204 and 205 should be run to test the DECTape system. On multiple transport systems the just formatted tapes should be swapped between the various transports to help detect any skew problems which will be manifested as random errors after the tapes have been swapped. If a skew problem is uncovered obtain a G500 TU55/56 skew tester module and following the cautions and procedures outlined, deskew the drives.

Read instructions completely before using.

CAUTION: If system has several transports which must be deskewed, be sure to recover data from tapes written with skew before deskewing all transports!

After much research and testing, it has been concluded that tapes marked "ZERO SKEW" and really have zero skew, are almost non-existent. As the tape ages and has undergone various handlings and abuses, such as dirty drives, misadjusted hubs, etc. the tape loses its physical specifications and thereby its usefulness as a "ZERO SKEW" reference. Also the oxide portion of the tape have not been applied with tight quality control and the tape itself may induce some skew even if formatted on a drive which has been conscientiously deskewed to zero time difference between tracks 0 and 10, therefore, **BWARE OF TAPES MARKED "ZERO SKEW" - THEY MAY NOT NECESSARILY BE!**

The only true, honest and accurate method of measuring skew is to format a tape and turn it over, so that oxide side is up and read this tape on the drive on which it has been formatted. The time difference between the two signals (track 1 and 10) is twice the actual skew of the transport.

CAUTION: Unless a tape has been marked "certified" by DEC, its operation and skew holding characteristics cannot be guaranteed. All DECTape skew work shall be done only with "certified" tape.

GLOSSARY: **SKEW:** Time difference between the signals on the timing tracks (track 1 and track 10), due to the head being other than perpendicular to the chassis mounting surface and path of tape travel.

REAL

SKEW: The value obtained when measuring the skew of a head against a zero skew tape.

Zero A tape on which there is zero time difference
SKEW between the timing tracks.

TAPE:

COMPANY CONFIDENTIAL

Title ADJUSTMENTS FOR DECTAPE SYSTEMS - Family of 8 (Continued)						Tech Tip Number TU56-TT-9		
All	Processor Applicability					Author Robert Nunley	Rev 0	Cross Reference
						Approval Frank Purcell	Date 12/06/72	

- TO USE:
- (1) Plug in skew tester AFTER selecting source of V plus, see NOTES on S3 and TO USE: (5), S3.
 - (2) Calibrate. See NOTES on S1 and TO USE: (5), S3.
 - (3) Select correct split winding, see NOTES on S2 and TO USE: (5), S2.
 - (4) Skew Test
 - A. Zero Skew Tape Available: (Certified DECTapes are not zero skew. They may have a 1 μ sec skew.) Run tape across head in normal manner. Gain of tester is enough to give clipped sine wave out. About 10V P/P. Go to step 4C. This skew is real.
 - B. No Zero Skew Tape Available. Clean tape head and guides. (4-E) Format Tape. Reverse tape so oxide side is up. (4-F) Now thread this tape from take-up reel across head with oxide up onto original supply reel. Move tape in local mode. Go to step 4C. The skew indicated is twice real skew.
 - C. Skew is measured by measuring the time difference between the two signals crossing a given reference line. Figure 1. To test skew; with tape in motion, depress lightly on the back edge of the tape on the right or left sides of the head. Record which side causes the skew to increase when pressure is applied to one side or the other. If the real skew is greater than 2 μ sec, the head should be deskewed. This tolerance will apply to both TU55 and TU56 transports to gain an added factor of interchangeability of tapes. If the head is to be deskewed, it should be taken as close to zero as possible. If a non-zero skew is used, it must be formatted after each attempt to deskew.
 - D. To deskew:
 1. Remove head and thoroughly clean back of head and mounting surface of all dirt, glue, skew shims, etc. Remount head and redo 4A or 4B as applicable.
 2. If shimming is necessary, magtape reflective marker (DEC #29-15191) is acceptable. Place the marker on the back of the head on the edge of the side which caused the skew to increase in step 4C. (For TU56 heads, the reflective tape must be placed only below the mounting screw.) Remount head being careful not to curl the ship tape edge and redo step 4A or 4B.

COMPANY CONFIDENTIAL

DIGITAL EQUIPMENT CORPORATION

digital	FIELD SERVICE TECHNICAL MANUAL				Option or Designator TU56
	12 Bit <input checked="" type="checkbox"/>	16 Bit <input checked="" type="checkbox"/>	18 Bit <input checked="" type="checkbox"/>	36 Bit <input checked="" type="checkbox"/>	

Title ADJUSTMENTS FOR DECTAPE SYSTEMS - Family of 8				Tech Tip Number	TU56-TT-9
All	Processor Applicability		Author Robert Nunley	Rev 0	Cross Reference
			Approval Frank Purcell	Date 12/06/72	

E. To Clean:

1. Heads and Guides: Use DECTape cleaning solution generously on the head, wiping dirt with clean, lint free towel (Kimwipe).
2. Guides: Disassemble guide from plate and thoroughly clean with solution all parts including wear plates, studs, springs, spring holes and guides themselves.
3. Tape: Place doubled clean, lint free towel over head; thread tape over towel; place free end of towel over tape.

Run tape from end-to-end at least once in each direction.

F. Reversing Tape: (Oxide side up)

Figure 4-F-1

Mount normally full reel of tape on right hub and empty reel on left. Thread tape from bottom of full spool onto top of empty reel. In local move all tape to left reel. This places oxide side up for skew test.

CAUTION: Maintain manual pressure on the supplying reel to prevent tape runaway.

(5) Switches: NC = DOWN NO = UP

S1 (Middle Switch) Calibrate - NO/Normal - NC

NO Select signal to lower amp to compensate for internal drift and phase shift of op amps. To calibrate, put switch in NO position, scope in Add, tape oxide side up and move tape in local. The two signals are 180° phase and should cancel. ADJ 10KPOT for smallest resultant signal. Return switch to NC position.

NC Signal from other half split winding is applied to lower amp for skew test. Do not adjust pot for any difference in amplitude. This difference is a result of low signal from one half of split winding due to skew.

COMPANY CONFIDENTIAL

Title ADJUSTMENTS FOR DECTAPE SYSTEMS - FAMILY OF 8 (continued)					Tech Tip Number TU56-TT-9	
All Processor Applicability			Author Robert Nunley	Rev 0		Cross Reference
			Approval Frank Purcell	Date 12/06/72		

TO USE: (5) Switches (continued)

S2 Top Switch: Select split winding, due to different vendors assigning different pins for head connection. If switch is in wrong position, S1G2 will be twice amplitude of S1G1 in normal position of S1, when oxide side up. If oxide side is down, a phase shift plus skew will result.

S3 Bottom Switch: For compatibility to R series transports NC-- +5V if applied to V plus.

NO-- +10V is divided to +5 for V plus.

CAUTION: This selection is to be made before voltages are applied.

TU55/56 Skew Tester may be placed in any empty slot which has +5 (or +10), -15, and ground in pins A2, B2 and C2 respectively.

Attach female data cable from head to male of tester.

PARTS LIST:

MC1709CG	19-9344 - E1 through E4
220 OHM 1/4W 5%	13-0271
4.7K 1/4W 5%	13-0447
1.5K 1/4W 5%	13-0391
22K 1/4W 5%	13-1808
10K POT	13-9143-10
470K 1/4W 5%	13-2398
330 OHM 1/2W 5%	13-0296
1N753A	11-2421
22pF 100V 5%	10-0021
10pF 100V 5%	10-0006
.01mf 100V 5%	10-1610
6.8 mf 35V 20%	10-0067
1 PST 6 AT1-T2	12-1168
Amphenol	
133-022-03	12-2909
680 OHM 1/2W 5%	13-0347

NOTES:

- Amphenol Pin Assignments
 - Pin A Skew Tap.
 - Pin D Center Tap.
 - Pin B solid winding on Western Magnetic head.
Split winding on Brush head.
 - Pin C Split winding on Western Magnetic or General Instrument.
Solid Winding on Brush.
Split winding for skew measurement.

digital	FIELD SERVICE TECHNICAL MANUAL				Option or Designator TU56	
	12 Bit <input checked="" type="checkbox"/>	16 Bit <input checked="" type="checkbox"/>	18 Bit <input checked="" type="checkbox"/>	36 Bit <input checked="" type="checkbox"/>		
Title ADJUSTMENTS FOR DECTAPE SYSTEMS - Family of 8 (Continued)					Tech Tip Number TU56-TT- 9	
All	Processor Applicability			Author Robert Nunley	Rev 0	Cross Reference
				Approval Frank Purcell	Date 12/06/72	

Notes: (continued)

2. M series use NC position of S3 (+5 applied to A2).
R series use NO position of S3 (+10 V applied to A).
3. E1-E4 MC1709 CG. Pin 4 = V minus Pin 7 = V plus.

Unless otherwise noted resistors are in OHM, 1/4W. 5%
4. MC1709 CG. 
Pin side.
5. S1 = calibrate/normal
S2 = select split winding
S3 = select V plus source

COMPANY CONFIDENTIAL

Title					ADJUSTMENTS FOR DECTAPE SYSTEMS - FAMILY OF 8					Tech Tip Number		TU56-TT-9	
(Continued)					Author					Robert Nunley		Rev 0	
All					Processor Applicability					Approval		Frank Purcell	
										Date		12/06/72	
												Cross Reference	

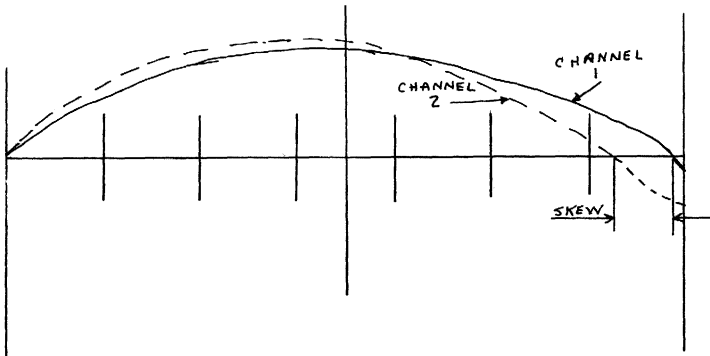

FIGURE 1

Input Coupling: AC; Sync: AC HF REJ; ADJ both CH to \emptyset level

Sync on channel 1. Put start of sweep at left end of X axis. Position seep 2 to start at same point. The difference in time where the two sweep across the X axis is the skew.

NOTE: Signals shown are for reference only to show skew measurement. They may be square wave (step 4A) or negative portion of this signal depending on tape direction (step 4B).

COMPANY CONFIDENTIAL

digital**FIELD SERVICE TECHNICAL MANUAL**

Option or Designator

TU56

CPL

12 Bit 16 Bit 18 Bit 36 Bit THE ADJUSTMENTS FOR DECRYPTE SYSTEMS - FAMILY OF 8
(Continued)Tech Tip TU56-PT-9
Number

All Processor Applicability

Author Robert Nunley

Rev 0

Cross Reference

Approval Frank Purcell Date 12/06/72

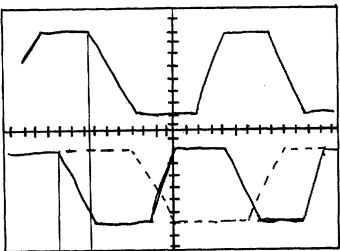
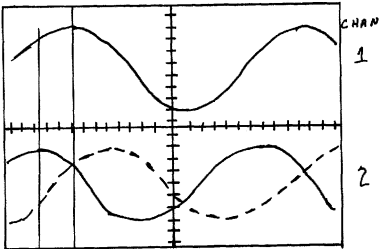
OXIDE SIDE DOWN
6500 OUTPUT ABOUT 10V P/POXIDE SIDE UP
6500 OUTPUT ABOUT 2V P/P

These pictures are for reference only, however can be used to illustrate a point.

Given: Tape: Moving Forward
Channel 2 leads channel 1 as shown.

If tape is reversed, channel 2 should lag channel 1, as shown with dotted lines, the same amount as it leads going forward. If this condition is not met, either amount is different or does not swap from lead to lag, It indicates faulty guides which must be cleaned or replaced.

COMPANY CONFIDENTIAL

REF. ONLY

FIC LRF 1A

PAGE 771

PAGE REVISION 0

PUBLICATION DATE

December 1972

Title ADJUSTMENTS FOR DECTAPE SYSTEMS - FAMILY OF 8 (Continued)					Tech Tip Number TU56-TT-9		
All	Processor Applicability				Author Robert Nunley	Rev 0	Cross Reference
					Approval Frank Purcell	Date 12/06/72	

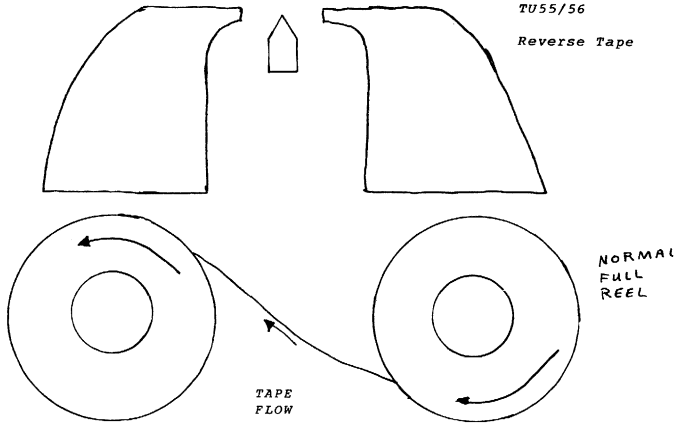

Link Tape: Put normal full reel on left hub, empty on right hub. Thread from bottom of left to top of right. In local wind all tape onto right reel.

FIGURE 4.F.1

COMPANY CONFIDENTIAL

DIGITAL EQUIPMENT CORPORATION

digital	FIELD SERVICE TECHNICAL MANUAL				Option or Designator
	12 Bit <input checked="" type="checkbox"/>	16 Bit <input checked="" type="checkbox"/>	18 Bit <input checked="" type="checkbox"/>	36 Bit <input checked="" type="checkbox"/>	TU56
Title ADJUSTMENTS FOR DECTAPE SYSTEMS - Family of 8 (Continued)				Tech Tip Number	TU56-TT-9
All	Processor Applicability	Author Robert Nunley	Rev 0	Cross Reference	
		Approval Frank Purcell	Date 12/06/72		

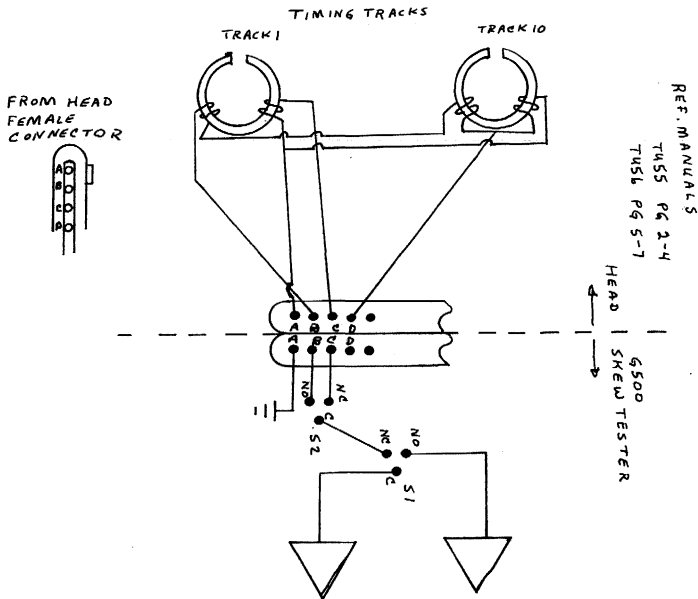

COMPANY CONFIDENTIAL

digital	FIELD SERVICE TECHNICAL MANUAL				Option or Designator
	12 Bit <input checked="" type="checkbox"/>	16 Bit <input checked="" type="checkbox"/>	18 Bit <input checked="" type="checkbox"/>	36 Bit <input checked="" type="checkbox"/>	TU56

Title	G848 MODULE REVISIONS				Tech Tip Number	TU56-TT-10
All	Processor Applicability		Author	Bill Kochman	Rev	β
X			Approval	Jeff Blundell	Date	02/21/73
						Cross Reference
						G848-TT-1

The "new" (triple height CS Rev. J) G848 module is not to be mixed with earlier CS Revisions within any TU56.

It follows therefore that only "old" (double height) G848's with ECO G848-008A may combine with triple height modules within a transport.

"Old" modules have been seen on the field with their handles stamped CS Rev. J (indicating that ECO G848-0008A has been installed), but without the ECO having been installed.

Play safe when you have to replace a "new" module with an "old" one, and check for the ECO #G848-008A rework, which consists of two 680 OHM resistors added to the base circuits of Q1 and Q3. One of them is positioned at the edge of the board near Pin BV, and the other is across the board about one inch from pins AB and AH.

Title	DECTape Reels Falling Off Drive				Tech Tip Number	TU56-TT-11
All	Processor Applicability		Author	Harry Drab	Rev	β
X			Approval	J. Blundell	Date	6/12/73
						Cross Reference

A batch of DECTapes wound onto oversized reels has escaped into the field. The total quantity of such reels is under 1,000, and the reels will cause problems only when mounted on hubs which are at the very low end of their dimensional tolerance.

Should customers complain of loose or falling DECTapes, check the following dimensions:

- I.D. of reel should be 2.495" to 2.505"
- O.D. of hub should be 2.510" to 2.525"

(The worst over-sized reel measured was 2.508")

If a customer has a large library containing suspected oversized reels, a gauge is available for loan from your regional support group to check these reels. Acceptable spare reels (part number 12-9331) can be obtained through normal field service spares channels.

This is not a blanket offer to replace all worn out DECTape reels in the field, you should be honestly convinced your customer really did receive oversize reels from Maynard before contemplating gauging and replacing reels.

COMPANY CONFIDENTIAL

Title TU56 Ground Problem						Tech Tip Number TU56-TT-12		
Processor Applicability						Author / W. Freeman Rev 0		Cross Reference
All X						Approval W. Cummins Date 12/5/73		

Problem: Poor data reliability; usually on transport in front of the power supply.

A possible reason for this problem may be improper ground connections in the TU56 or 725 power supply (usually in the power supply). The TU56 has two separate ground systems. One for the external supplies (+5 or +10 and -15) and one for the reel motor power supply (725). These ground systems are designed so that motor current does not return on the external supplies ground line. The two ground systems are commoned at a virtual current node on the G848 "Motor Drive" modules. If the two grounds were shorted within the 725 power supply or if one of the grounds was open sufficient noise could be generated to cause data errors.

To check for this problem perform the following steps:

1. Remove all (4) G848 modules from the TU56.
2. Measure the resistance between the two ground connectors on the front of the 725 power supply. The resistance should be infinite.
3. Measure the resistance between each harness connector (pin 3) which you have disconnected from a G848 and the ground side of each filter capacitor in the 725 power supply. This resistance should be zero (a short circuit).

If 2 above is not true find the short and repair.

If 3 above is not true find the open and repair. Usually this is caused by a poor stripping of wire or a poor crimping of the AMP connectors.

Title TU55/56 SPIDER HUB VARIATIONS						Tech Tip Number TU56-TT-13		
Processor Applicability						Author Sweeney/Newbery Rev 0		Cross Reference
All X						Approval R. Boehm Date 4-5-74		

Recently there has been some confusion over the set-screw placement in the "spider hubs" used on the TU55 and TU56. (hub part #74-07390)

Initially, the set screws were aligned at 180° apart on the hub. This positioning created an excessive amount of stress on the hub threads, which usually resulted in the hubs becoming loose and unusable after a short period of time.

The problem has currently been rectified by re-lay out of the set-screws. The set-screws are now mounted 120° apart, and this seems to have alleviated the earlier problem of thread/hub damage.

In an effort to use up existing stock, the old units (with the 180° spacing) had their original holes bored out oversize so that insertion of set screws is impossible (unless you go through the trouble of purchasing oversize screws locally). These old units were then re-bored and tapped at the new displacement. (e.g. 120° apart). There are about 800 of these re-worked spider hubs in existence, so don't panic if you come across some with four holes in them.

All new units will have the 120° spacing.

Offsetting the screws in this fashion has not created any wobble effects from the slight hub weight imbalance.

digital	FIELD SERVICE TECHNICAL MANUAL				CPI Option or Designator
	12 Bit <input checked="" type="checkbox"/>	16 Bit <input checked="" type="checkbox"/>	18 Bit <input checked="" type="checkbox"/>	36 Bit <input checked="" type="checkbox"/>	TU56

Title TU56 TAPE BOUNCE/EARLY TAPE WEAR				Tech Tip Number TU56-TT-14	
All Processor Applicability			Author Bill Connors Ray Alvarez	Rev #	Cross Reference
X			Approval Dick Russell	Date 6/19/74	

A number of TU56's have been installed in the Field that wear out tapes in an unreasonably short time. Most of the tape failures occur around the beginning of tape, where the directory and system areas are located. Investigation of the problem has shown that the errors are caused by tape physically lifting off the head, or "bouncing," when a section of dectape has worn narrow by enough to fit between the backplate and the wear plates without touching them. The "bouncing" of the unrestricted tape is a characteristic of the TU56's square wave-driven motors, the severity of the bounce being a function of capacitor l/motor mismatch, but the bounce is suppressed as long as the wear plates are in contact with the edge of the tape. Situations may exist where a guide is spaced out away from the mechanical front panel or a wear plate doesn't ride properly, causing dectape to bounce on a TU56 which is otherwise in top condition.

The following sections describe a method for determining if bounce is present or if a TU56 is wearing tape out and how to correct the problems.

A. TAPE BOUNCE

The bounce that lifts tape is caused by the change in motor torque produced when the G848 switches applied motor voltage. To see the effects of the bounce on a scope, shim the wear plate back and load a basic tape motion routine into the processor and exercise only the first few blocks at the beginning of tape.

SET UP THE SCOPE AS FOLLOWS:

external (use Signal "Fwd H" A7H1
10ms/Div
"B" DLYD
AC or DC
auto-trigger
chopped
chan 1 .5V/Div
chan 2 10V/Div

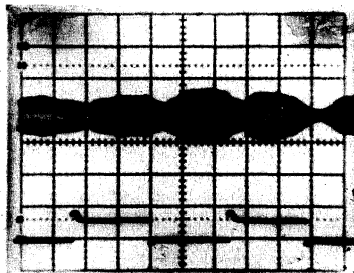

Place channel 1 on any power transistor case on the G848 driving the right hand motor, and place channel 2 on the analog output of the timing track amplifier, examp: A14 pin H2 on the G888.

Title TU56 TAPE BOUNCE/EARLY TAPE WEAR (CONT.)					Tech Tip Number TU56-TT14	
Processor Applicability			Author Bill Connors Ray Alvarez		Rev ϕ	
All			Approval Dick Russell		Date 6/19/74	
X						

When the tape lifts off the head, the TT amplitude goes to zero. It may be necessary to trigger from the square wave driver (channel 1) to see a clearer picture. Tape bounce occurs only under the following conditions:

- 1) The tape is free to move vertically; ie., whenever tape is worn narrowly enough to fit between the back plate and wear plates without touching either of them, or when the wear plates are shimmed out away from the tape.
- 2) The driving motor is turning on empty reel (forward tape motion at BOT or reverse tape motion at EOT).
- 3) The driving motor and capacitor are not perfectly matched (which is almost always the case).

The severity of the bounce is directly related to the degree of mismatch between the driving motor and its capacitor. Drag motor mismatch will not cause or prevent bounce. A normal TU56 with proper wear plate contact, even with severe driving motor mismatch, will show up to a 20% reduction in the peak to peak timing track analog output voltage. A 40% - 50% loss of amplitude due to bounce will cause random marktrack errors, and greater than 50% loss of amplitude will cause fairly frequent marktrack and data errors. These figures are for a de-skewed TU56; bounce can be aggravated by out of skew guider and heads. Once a particular dectape has worn width-wise to the point that it is free to move vertically, bounce is inevitable and the tape must be discarded. Bounce is also related, occasionally, to power supply grounding problems. Before you suspect tape wear problems and order expensive tape guide parts, its probably a good idea to install ECO #725-12. This is particularly the case if marktrack errors occur with equal frequency throughout the life of the tape, or if marktrack errors occur more frequently when both drivers are on-line, instead of one on-line. ECO #725-12 has cured more than one intermittent TU56.

NOTE: Timing track output during start/stop sequence when tape is accelerating/decelerating should not be confused with tape bounce. This is due to normal gain changes during direction changes.

50msec/div
Chan 1 .5V/div
Chan 2 10V/div

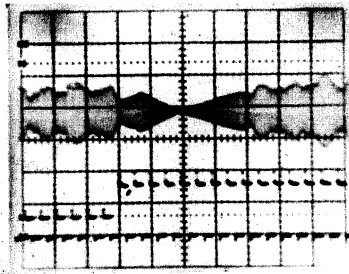

CPL				
digital	FIELD SERVICE TECHNICAL MANUAL			Option or Designator
	12 Bit <input checked="" type="checkbox"/>	16 Bit <input checked="" type="checkbox"/>	18 Bit <input checked="" type="checkbox"/>	36 Bit <input checked="" type="checkbox"/>
				TU56

Title TU56 TAPE BOUNCE/EARLY TAPE WEAR (CONT.)			Tech Tip Number TU56-TT-14	
All Processor Applicability		Author BILL CONNORS RAY ALVAREZ	Rev #	Cross Reference
X		Approval Dick Russell	Date 6/19/74	

B. TAPE WEAR:

The rate at which a dectape wears width wise depends on the following:

- 1) The finish of the ceramic wear plate.
- 2) The finish of the black-oxide coated rear cheek plate (back-plate).
- 3) The amount of spring tension applied to the wear plate.
- 4) The depth of the wear plate pocket, which determines how much of a wear away before it is free to bounce.

The amount of spring tension applied to the wear plate also has a great effect on how fast the edge of a dectape will wear. The former springs were stiff and not ideally located, putting 100 grams pressure on the high side of the wear plate and \approx 200 grams pressure on the low side.

ECO#700-6320-001 installs a new style spring which applies \approx 40 grams pressure to the wear plate on each side. The lighter spring pressure reduces tape wear, but it isn't as tolerant of out of skew guides or of misaligned or wobbly reel hubs. If a TU56 has the lighter wear plate-springs, make sure the hubs don't wobble excessively and the guides are on straight. Check ECO write-up for parts for compatibility considerations. The minimum specified width for dectape is 744 mils, while the maximum distance from the back of the old tape guide to the front edge of its wear plate pocket is 742 mils. Under worst case tolerance, a dectape should "overlap" the wear plate pocket by 2 mils; a tape should have to wear 2 mils narrower before it begins to fail. ECO#700-6320-001 increases the wear plate pocket depth by 4 mils, making the minimum overhang 6 mils under worst case tolerance; this will increase tape life by giving the wear plates another 4 mils of tape edge to wear down before tape failures. Consider the two implications of this "overhang" dimension:

- 1) Any small burr under a tape guide, or a locating pin that doesn't fit smoothly in its hole, can space the guide out to the point that the "overhang" doesn't exist; instant bounce! With only 2 mils to play with it is critical that the guides fit flush against the TU56 base casting.
- 2) If a dectape is used extensively on a TU56 with the deeper plate pocket and it wears to the point that the "overhang" dimensions is less than 4 mils, the tape will fail, due to bounce, it will also fail if it is put on a TU56 with shallow wear plate pockets. This difference in wear plate pocket depths can cause a storm of compatability complaints if all TU56's in a system are not updated at the same time--please educate your customers!

Title						Tech Tip	
TU56 TAPE BOUNCE/EARLY TAPE WEAR (CONT.)						Number TU56-TT-14	
Processor Applicability						Author Bill Connors	
All						Rev ϕ	
X						Approval Dick Russell Date 6/19/74	
						Cross Reference	

C) QUICK FIELD CHECKS

- 1) Scope TT output to confirm the bounce.
- 2) Check the "overhang" on a new tape and on the failing tape; minimum 2 mils for old guides, 6 mils for new use feeler guage against back plate. Reseat/Replace guides as necessary to get the proper dimension.
- 3) Insure that the wear plates are free to move and follow the tape. Clean/replace the wear plates and springs as necessary; also check the surface finish of the rear cheek plates on the TU56. Cheek plates which are rough, scratched, or worn can contribute heavily to tape wear problems. As a general rule, if a customer is having tape wear problems which are serious enough to require installation of new tape guides and coverplate, the cheek plates should be replaced at the same time.
- 4) Make sure that tape is being handled smoothly by the drive; guides straight, hubs aligned and straight.
- 5) If bounce is still particularly severe with one motor, use a lower value capacitor. Values >100 μ f cause bounce; values < 80 μ f don't provide enough torque.

Title						Tech Tip	
TU55/56 SPIDER HUB STORAGE						Number TU56-TT-15	
Processor Applicability						Author Harry Drab	
All						Rev ϕ	
X						Approval Jeff Blundell Date 6/25/74	
						Cross Reference	
						TU55-TT-10	

The following procedure, unorthodox as it seems, has been found to be an effective fix for the problem of dectape reels and dectape hubs intermittently parting company at inopportune moments.

It has been found that replacement hubs are being shipped with an insufficient moisture content. Plastic does absorb some moisture, and this effects not only its absolute dimensions, but also its elasticity.

By keeping replacement hubs in a sealed plastic bag together with a moistened paper towel, this moisture deficiency will be corrected, resulting in a slightly larger hub which has a firmer grip on any reel which is mounted on it.

Customers who experience reel/hub fit problems due to apparently under-size hubs should have new hubs installed which have received the above moisturizing treatment.

(The Field Service stockroom has been advised to use this procedure, so the wet towelling received with your 74-07390's is intentional):

CPL

digital	FIELD SERVICE TECHNICAL MANUAL				Option or Designator
	12 Bit <input checked="" type="checkbox"/>	16 Bit <input checked="" type="checkbox"/>	18 Bit <input type="checkbox"/>	36 Bit <input type="checkbox"/>	TU60

Title	Coupling, Cassette Drive			Tech Tip TU60
				Number TT #1
All	Processor Applicability	Author Ken Quinn	Rev 0	Cross Reference
	11 8	Approval Chris Ball	Date 9-10-74	

The couplings that drive the tape are bonded to the shaft of the tension motor and the spindle assembly. If for any reason the coupling becomes loose the complete assembly should be replaced using the following part numbers;

Spindle Assembly: 70-09146-00
 Motor Assembly, Tension: 70-10277-00

The 2nd printing of the TU60 Illustrated Parts Breakdown (DEC-TU60-IPB-2) has an incorrect part number for the Tension Motor Assembly and it should be corrected with the above part number.

Title DANGER OF BURN TO SKIN						Tech Tip TYPESET HARDWARE Number TT-1		
All 8	Processor Applicability					Author Fred Miller	Rev 0	Cross Reference
	11	10				Approval Fred Miller	Date 5/17/73	

DANGER OF BURN TO SKIN ON TYPESET

READER/PUNCH CONTROLS

A bleeder resistor was attached to the 798 power supply by an ECO many years ago. The resistor was mounted on the top of the power supply and the supply was then mounted on the back door of the cabinet that housed the respective controller. If the system has been on for awhile, and if you are working on some logic in the controller cabinet by accessing it via the back door, and the door swings shut on you the chance of a skin burn from the now "Hot" bleeder resistor exists.

If this has happened to you or you want to prevent it from possibly happening the following is a list of controllers the danger may exist on and to the right is the ECO which tells you how to prevent it by moving the resistor to a safer location inside the power supply.

<u>Option</u>	<u>ECO To Use</u>
PA 61	04
PA 68A	06
PA 63	16
PA 68P	18
PA 611	06

All new systems will have the above ECOs incorporated.

COMPANY CONFIDENTIAL

CPL

digital	FIELD SERVICE TECHNICAL MANUAL				Option or Designator
	12 Bit <input type="checkbox"/>	16 Bit <input checked="" type="checkbox"/>	18 Bit <input type="checkbox"/>	36 Bit <input type="checkbox"/>	TYPESET SOFTWARE

Title			STARTING TYPESETTING PROGRAMS WITHOUT A TELETYPE		Tech Tip TYPSET Number SFTWRE-TT-1	
All 8's	Processor Applicability		Author	Bezeredi/Tinkham	Rev	0
			Approval	W. Cummins	Date	7-31-72

The typesetting system loader requires teletype input to start any of the typesetting programs. For example, an "A" for the Auto Loader Program, etc. If for some reason, such as teletype malfunctions or computer failure, teletype input is not available, it would be impossible to start any typesetting programs.

The following instructions will give the user a method to temporarily patch the typesetting system loaders. This will enable him to bypass the teletype input routing and input the desired information through the switch register.

For non-disk Dectape only programs:

- 1) Load and start the bootstrap loader at 7730. When the DECTape stops moving, stop the computer using the STOP key.
- 2) Load address 7054
 - Press examine - MB lights should indicate 6031
 - Press examine - MB lights should indicate 5254
 - Press examine - MB lights should indicate 6036

This is the teletype flag loop in which the system loader waits for an input from the keyboard.

- 3) Load address 7056 - deposit 7604.
- 4) Load address 7056.
- 5) Set switch register to the ASCII octal code for the letter normally used to select the program which you want to be loaded. (See Table 1).
- 6) Press start - the program will accept the code from the SR; the selected program will be loaded and started, and normal operation can resume.

For Disk Dectape Programs:

- 1) Same as above.
- 2) Load address 6256.
 - Press examine - MB lights should indicate 6031.
 - Press examine - MB lights should indicate 5256.
 - Press examine - MB lights should indicate 6036.
3. Load address 6260 - deposit 7604.

COMPANY CONFIDENTIAL

Disk DECTape Systems (Continued)

- 4) Load address 6260.
- 5) Same procedure as five above.
- 6) Same procedure as six above.

Disk Alone Systems:

- 1) Load and start the program at 7730. The computer lights will flash and in approximately five seconds the computer can be stopped using the stop key.
- 2) Load address 7027
 Press examine - the MB lights should indicate 6031.
 Press examine - the MB lights should indicate 5227.
 Press examine - the MB lights should indicate 6036.
- 3) Load address 7031 - deposit 7604.
- 4) Load address 7031.
- 5) Same procedure as five above.
- 6) Same procedure as six above.

TABLE 1 - ASCII OCTAL CODES

A = 0301 E = 0305 J = 0312 N = 0316 T = 0324 Y = 0331 4 = 0264
 B = 0302 F = 0306 K = 0313 P = 0320 U = 0325 Z = 0332 5 = 0265
 C = 0303 H = 0310 L = 0314 R = 0322 W = 0327 7 = 0267
 D = 0304 I = 0311 M = 0315 S = 0323 X = 0330

NOTE: Some letters i.e., programs, may not be available on all systems.

Title					Tech Tip		TYPSET		
TYPESETTING LOADERS					Number	SFTWRE-TT-2			
Processor Applicability					Author	John Gleeson	Rev	g	Cross Reference
All	8's	//s			Approval	Bill Cummins	Date	7-31-72	

There are eight loaders for use with typesetting programs. They are:

- 1) Typesetting RIM Loader
- 2) 552 Typesetting Bootstrap Loader (DECTape only)
- 3) 552 Typesetting Bootstrap Loader (DECTape with or without Disk).
- 4) TC01 Typesetting Bootstrap Loader (DECTape only)
- 5) TC01 Typesetting Bootstrap Loader (DECTape with or without Disk).
- 6) DF32 Typesetting Bootstrap Loader (Disk only)
- 7) DF32 Typesetting Disk Refresh Program
- 8) Eight Level Typesetting RIM Loader (Teletype).

COMPANY CONFIDENTIAL

digital	FIELD SERVICE TECHNICAL MANUAL				Option or Designator
	12 Bit <input type="checkbox"/>	16 Bit <input checked="" type="checkbox"/>	18 Bit <input type="checkbox"/>	36 Bit <input type="checkbox"/>	TYPESET SOFTWARE

Title TYPESETTING LOADERS (Continued)				Tech Tip Number	TYPSET SFTWRE-TT-2
All	Processor Applicability		Author J. Gleeson	Rev 0	Cross Reference
8's	/	/	Approval W. Cummins	Date 7-31-72	

In summary, the RIM loader is toggled into memory by way of the console keys or Hard Wired RIM. In a basic system, i.e., one without DECTape or Disk, the RIM loader is used directly to read in the typesetting program which is on 6 level paper tape. In an expanded system, where the program is either on DECTape or Disk, the RIM loader is used to read in a bootstrap loader (one of programs 2 through 6), which then calls down a monitor program from the tape or disk. This monitor program is then used to call down the typesetting program required. The Disk Updater (for use with a non-DECTape, disk only system) is used to load typesetting programs onto the disk during installation, after maintenance or if lost due to malfunction; the programs are then available to be called down as required.

The eight level RIM loader is used to read in any one of programs 2 thru 6, in eight level form, through the teletype; the teletype may be more convenient for use than a typesetting reader in an installation where the readers are situated on another floor, or at an inconvenient distance from the computer.

1. TYPESETTING RIM LOADER - (See "Typesetting Rim and Binary Loader" Section 14, Page 13 of this manual for a detailed description). This will only read tape punched in six level RIM coding through a PR68A Typesetting Reader or PC02 High Speed Reader. The Typesetting RIM loader is as follows:

7756/	ØØØØ	7763/	71Ø6	*777Ø/	4356
7757/	6Ø14	7764/	6Ø12	7771/	3373
776Ø/	6Ø11	7765/	742Ø	7772/	4356
7761/	536Ø	7766/	5357	7773/	ØØØØ
7762/	71Ø6	7767/	5756	7774/	ØØØØ

* Starting Address

This loader, as listed, will only load through reader zero. If reader zero is inoperative, or if it is desirable to use a different reader, modify the loader as follows:

7773 -	76Ø4	OSR
7774 -	6312	RDS
7775 -	73ØØ	CLA CLL
7776 -	537Ø	JMP.-6

Starting Address = 7773

Load 7773; set the number of reader to be selected in the switch register (bits 8, 9, 10, 11) and press start. The use of these addresses for these instructions will not interfere in any way with

Title TYPESETTING LOADERS (Continued)						Tech Tip Number	TYPSET SFTWR-TT-2	
All 0's	Processor Applicability					Author J. Gleeson	Rev 0	Cross Reference
	1/1					Approval W. Cummins	Date 7-31-72	

any typesetting program which DEC supplies; depositing a similar program modification at some other location might.

The Typesetting RIM loader is used to read in the following program tapes:

- A Hot Metal or Photo-Comp Six Level Program Tape
- A Wire Stripping Program Tape
- A TTS Punch Routine (Core Dump)
- A 552 Typesetting Bootstrap Loader
- A TC01 Typesetting Bootstrap Loader
- A DF32 Typesetting Bootstrap Loader
- DF32 Typesetting Disk Refresh Program

Typesetting Bootstrap Loaders (Programs 2-5, DECTape Systems)

These are often referred to by other names such as Unit 4 Bootstrap or Bootstrap or UNIT 4 System Loader, or Typesetting Loader; they all mean the same. Each is a program similar in nature to the DEC Library Systems Bootstrap Loader and is very similar in operation. It is stored from 7730 to 7755 in memory field 0, and it is usually found in six level RIM format on six level tape although it could be on eight level tape when the system has eight level reader capability (holes 6 and 7 are not used). Its purpose is to rewind the customer's typesetting program tape on Unit 4 to end zone then turn around and read a much larger program into memory at 7400, then jump to that program, (the monitor program which prints out "SELECT PROGRAM TO BE LOADED"). This allows the user to select a particular typesetting program by the use of a "program designator". The applicable designators are documented in the system software or System User's Guide which is part of the customer's typesetting program documentation.

2. The 552 Typesetting Bootstrap Loader (DECTape only)

*7730	1347	TAD K1
31	6757	MMLF MMLF MMLM (MMM)
32	4350	JMS WAIT
33	4350	JMS WAIT
34	1346	TAD K2
35	6756	MMLF MMLM
36	4350	JMS WAIT
37	1345	TAD K3
7740	6766	MMMC MMLC (MML)
41	4350	JMS WAIT
42	6756	MMLF MMLM
43	4350	JMS WAIT
44	5745	JMP I K3

-- NOTES --

-- NOTES --

digital	FIELD SERVICE TECHNICAL MANUAL				Option or Designator TYPESET SOFTWARE
	12 Bit <input checked="" type="checkbox"/>	16 Bit <input checked="" type="checkbox"/>	18 Bit <input type="checkbox"/>	36 Bit <input type="checkbox"/>	

Title TYPESETTING LOADERS (Continued)				Tech Tip TYPESET Number SFTWRE-TT-2	
All Processor Applicability		Author J. Gleeson	Rev 0	Cross Reference	
8's	/s	Approval W. Cummins	Date 7-31-72		

2. The 552 Typesetting Bootstrap Loader (DECTape Only) (Continued)

7745	7400	K3,	7400
46	0022	K2,	0022
47	0430	K1,	0430
7750	0000	WAIT,	0
51	6761		MMSF
52	5351		JMP.-1
53	6772		MMCF
54	5750		JMP I WAIT
55	7400		HLT

This unit 4 loader was first used in February '66 and served until the addition of DF32's to the Typesetting configuration. This loader included the DF32's "Word Count" and "Current Address" locations and, since those locations would be modified by the operation of the disk, required frequent reloading. This loader may be used on a 552, disk-less system and may be replaced with the 552 Disk Typesetting Bootstrap Loader.

3. 552 TYPESETTING BOOTSTRAP LOADER (DECTape with disk, or non-disk)

Disk-552 Loader

* 7730	1347	TAD K1	7743	4351	JMS WAIT
7731	6757	MMMM	7744	5745	JMP I K3
7732	4351	JMS WAIT	7745	7400	K3, 7400
7733	4351	JMS WAIT	7746	0022	K2, 0022
7734	1346	TAD K2	7747	0430	K1, 0430
7735	6756	MMLF MMLM	7750	0000	
7736	4351	JMS WAIT	7751	0000	WAIT 0
7737	1345	TAD K3	7752	6761	MMSF
7740	6766	MMML	7753	5352	JMP.-1
7741	4351	JMS WAIT	7754	6772	MMCF
7742	6756	MMLF MMLM	7755	5751	JMP I WAIT

This loader was created when the DF32 was added to Typesetting. Customers who have a 552 control and add a DF32 to their present configuration will require this loader.

COMPANY CONFIDENTIAL

Title TYPESETTING LOADERS (Continued)						Tech Tip Number		TYPSET-TT-2 SETWRE	
A" Processor Applicability				Author J. Gleeson		Rev 0		Cross Reference	
B's				Approval W. Cummins		Date 7-31-72			

4. TCØ1 TYPESETTING BOOTSTRAP LOADER (DEctape only)

/STARTING ADDRESS = 773Ø

6 771	DTSF=6771		/SKIP ON DECTAPE FLAG
6762	DTCA=6762		/CLEAR STATUS REGISTER "A"
6764	DTXA=6764		/XOR STATUS REGISTER "A"
6774	DTLB=6774		/LOAD STATUS REGISTER "B"
7754	WC=7754		/3-CYCLE BREAK WORD COUNT
7755	CA=7755		/CURRENT ADDRESS REGISTER
			for DEctape
773Ø	*773Ø		
*773Ø	6774	START,	DTLB /CLEAR "B" (EXTENDED MEM BITS)
7731	1347	TAD MOVREV	/MOVE IN REVERSE
7732	4341	JMS DWAIT	
7733	724Ø	CLA CMA	
7734	1351	TAD ADDR	/SET CA FOR DATA TRANSFER
7735	3355	DCA CA	
7736	135Ø	TAD READF	
7737	4341	JMS DWAIT	/START READ FORWARD
774Ø	5751	JMP I ADDR	
7741	ØØØØ	DWAIT, Ø	/WAIT FOR DECTAPE FLAG
7742	6766	DTCA DTXA	/CLEAR AND LOAD STATUS "A"
7743	3354	DCA WC	/RESET WORD COUNT
7744	6771	DTSF	
7745	5344	JMP -1	
7746	5741	JMP I DWAIT	
7747	46ØØ	MOVREV, 46ØØ	/STATUS "A" MOVE REVERSE
775Ø	422Ø	READF, 422Ø	/ READ FORWARD
7751	74ØØ	ADDR, 74ØØ	/STARTING ADDRESS OF TRANSFER

This loader was first used in October 1967 and served until the DF32 was added to Typesetting. It also included the DF32's "Word Count" and "Current Address" locations and required frequent reloading. It is suitable only for a TCØ1, non-disk system.

COMPANY CONFIDENTIAL

CPL

digital	FIELD SERVICE TECHNICAL MANUAL				Option or Designator
	12 Bit <input checked="" type="checkbox"/>	16 Bit <input checked="" type="checkbox"/>	18 Bit <input type="checkbox"/>	36 Bit <input type="checkbox"/>	TYPESET SOFTWARE

Title TYPESETTING LOADERS (Continued)				Tech Tip TYPSET Number SFTWRE-TT-2	
All Processor Applicability	Author J. Gleeson	Rev 0	Cross Reference		
8's <i>1/3</i>	Approval W. Cummins	Date 7-31-72			

5. TCØ1 TYPESETTING BOOTSTRAP LOADER (DECTape with disk, or non-disk)

```

                                /STARTING ADDRESS = 773Ø
6771      DTSF=6771              /SKIP ON DECTAPE FLAG
6762      DTCA=6762            /CLEAR STATUS REGISTER "A"
6764      DTXA=6764            /XOR STATUS REGISTER "A"
6774      DTLB=6774            /LOAD STATUS REGISTER "B"

7754      WC=7754              /3-CYCLE BREAK WORD COUNT } for
7755      CA=7755              /CURRENT ADDRESS REGISTER } DECTape

773Ø      *773Ø

* 773Ø 6774 START, DTLB        /CLEAR "B" (EXTENDED MEM BITS)
7731 1347 TAD MOVREV          /MOVE IN REVERSE
7732 4341 JMS DWAIT
7733 724Ø CLA CMA
7734 1353 TAD ADDR           /SET CA FOR DATA TRANSFER
7735 3355 DCA CA
7736 1352 TAD READF
7737 4341 JMS DWAIT          /START READ FORWARD
774Ø 5753 JMP I ADDR

7741 ØØØØ DWAIT, Ø           /WAIT FOR DECTAPE FLAG
7742 6766 DTCA DTXA          /CLEAR AND LOAD STATUS "A"
7743 3354 DCA WC             /RESET WORD COUNT
7744 6771 DTSF
7745 5344 JMP .-1
7746 5741 JMP I DWAIT

7747 46ØØ MOVREV, 46ØØ      /STATUS "A" MOVE REVERSE
775Ø ØØØØ                   /WC for disk

```

COMPANY CONFIDENTIAL

digital	FIELD SERVICE TECHNICAL MANUAL				Option or Designator
	12 Bit <input checked="" type="checkbox"/>	16 Bit <input checked="" type="checkbox"/>	18 Bit <input type="checkbox"/>	36 Bit <input type="checkbox"/>	TYPESET SOFTWARE

Title TYPESETTING LOADERS (Continued)				Tech Tip Number	TYPSET SFTWRE-TT-2
All	Processor Applicability			Author	J. Gleeson
8'S	/ s			Rev	0
				Approval	W. Cummins
				Date	7-31-72
					Cross Reference

8. 8 LEVEL TYPESETTING RIM LOADER (Teletype) continued

	Present characters on Bootstrap tape	Change to
1st six	26	remains the same
	17	"
	14	16
	32	remains the same
	17	"
	10	12
last six	26	remains the same
	17	"
	14	16
	32	remains the same
	15	"
	10	"

2. Convert the modified 6 level bootstrap (in reader θ) to an 8 level (TTY) by the following program:

```

2000/ 6016 RRB, RFC
1/ 6011 RSF
2/ 5201 JMP.-1
3/ 6046 TLS
4/ 6041 TSF
5/ 5204 JMP.-1
6/ 7200 CLA
7/ 5200 JMP.-7

```

3. The typesetting rim loader can then be replaced by the following loader, to read in this 8 level bootstrap:

COMPANY CONFIDENTIAL

Title						TYPESETTING LOADERS (Continued)			Tech Tip	
All						Processor Applicability			Author J. Gleeson	
8's						Approval W. Cummins			Rev 0	
s						Date 7-31-72			Cross Reference	
									TYPSET-TT-2 SOFTWARE	

8. 8 LEVEL TYPESETTING RIM LOADER (Teletype) continued

3.	7756/	----	char, 0
	7/	6031	KSF
	60/	5357	JMP.-1
	1/	7106	CLL RTL
	2/	7106	CLL RTL
	3/	6034	KRS
	4/	3377	DCA TEMP
	5/	6032	KCC
	6/	1377	TAD TEMP
	7/	7420	SNL
	70/	5357	JMP CHAR+1
	1/	5756	JMP I CHAR
*	2/	4356	JMS CHAR /START ADDRESS
	3/	3375	DCA ASSEM
	4/	4356	JMS CHAR
	5/	----	ASSEM, 0
	6/	----	0
	7/	----	TEMP, 0

NOTE: In programs shipped before April 1970 (approximately) location 7773 is used as a "Reader #" store, hence the instruction 3375 gets wiped out when the program is running. To avoid redepositing this instruction every time the loader is used, programs can be patched to use location 7776 instead of 7773.

COMPANY CONFIDENTIAL

CPL

digital	FIELD SERVICE TECHNICAL MANUAL				Option or Designator
	12 Bit <input checked="" type="checkbox"/>	16 Bit <input checked="" type="checkbox"/>	18 Bit <input type="checkbox"/>	36 Bit <input type="checkbox"/>	Typeset Software

Title TYPESETTING RIM AND BINARY LOADER				Tech Tip TYPSET		
				Number SFTWRE-TT-3		
All	Processor Applicability			Author John Gleeson	Rev 0	Cross Reference
	g's / /s			Approval W. Cummins	Date 7-31-72	

Introduction - In a basic typesetting system, i.e., one without DECTape or Disk, the typesetting program is on 6 level paper tape. Reading of the tape is begun using the Typesetting RIM Loader. The first part of the tape contains a binary loader which is read in and assembled by the RIM loader. When assembly of the binary loader is complete, control transfers from the RIM loader to the binary loader which then reads in the rest of the tape containing the typesetting program.

Tape Format - Each instruction or data word is on tape as three 4 bit characters. The first character of each also has hole Ø4 perforated which is used to set the link when a word assembly is complete. From the beginning the first characters read are:

26 17 14, 32 17 1Ø, 26 1Ø Ø, 36 14 Ø, 26 1Ø Ø1, 26 13 14,
 26 1Ø Ø2, 3Ø 12 Ø4, 26 1Ø Ø3, 37 Ø2 1Ø, 26 1Ø Ø4, 32 1Ø Ø2, --

Three passes through the assembly routine in the RIM loader are necessary for each word. Reading of the character into the AC follows the CLL RTL instructions, hence for each word assembly, the first character is rotated left 8 places, the second character 4 places, and the third character zero places. Taking the characters shown above, these are assembled into the following instructions:

26	32	26	36	26	26	26	30	26	37	26	32
17	17	1Ø	14	1Ø	13	1Ø	12	1Ø	Ø2	1Ø	1Ø
14	1Ø	Ø	Ø	Ø1	14	Ø2	Ø4	Ø3	1Ø	Ø4	Ø2
* 3374	537Ø	32ØØ	73ØØ	32Ø1	3274	32Ø2	4244	32Ø3	745Ø	32Ø4	52Ø2

- * Ø ØØØ ØØØ Ø1Ø 11Ø - 2b read in
 - Ø ØØØ 1Ø1 1ØØ ØØØ - 26 rotated 4 places left
 - 1 Ø11 Ø11 11Ø ØØØ - 17 read in/AC rotated 4 places left
 - 1 Ø11 Ø11 111 1ØØ - 14 read in-word assembly completed
- 1 3 3 7 4

The end of the binary loader is:

Beginning of Program

26	2Ø	26	2Ø	26	26	2Ø	26	32	2Ø	13
13	Ø2	13	Ø3	13	Ø7	14	1Ø	17	1Ø	Ø
15	Ø	16	17	17	17	Ø	Ø	14	Ø	Ø1
3275	ØØ4Ø	3276	ØØ77	3277	Ø177	33ØØ	Ø2ØØ	3374	52ØØ	ØØØ1
									54Ø3	

COMPANY CONFIDENTIAL

CPL

digital	FIELD SERVICE TECHNICAL MANUAL				Option or Designator
	12 Bit <input checked="" type="checkbox"/>	16 Bit <input checked="" type="checkbox"/>	18 Bit <input type="checkbox"/>	36 Bit <input type="checkbox"/>	TYPESET SOFTWARE

Title TYPESETTING RIM AND BINARY LOADER (Continued)				Tech Tip TYPESET-TT-3	
Processor Applicability				Author J. Gleeson	Rev 0
All 8's <input type="checkbox"/> 11's <input type="checkbox"/>				Approval W. Cummins	Date 7-31-72
				Cross Reference	

Binary Loader

/6 CHANNEL BINARY LOADER

0000 OPEN=0000
7600 *7600

7600	7300	BEGIN,	CLA CLL	7641	5222	JMP B
7601	3274		DCA CKSUM	7642	7402	HLT
7602	4244		JMS READ	7643	5200	JMP BEGIN
7603	7450		SNA	7644	0000	READ, OPEN
7604	5202		JMP , -2	7645	3271	DCA TEMPB
7605	7106	A,	CLL RTL	7646	6014	RFC
7606	7106		CLL RTL	7647	6011	RSF
7607	4244		JMS READ	7650	5247	JMP , -1
7610	7106		CLL RTL	7651	6012	RRB
7611	7106		CLL RTL	7652	0275	AND K40
7612	4244		JMS READ	7653	7640	SZA CLA
7613	3270		DCA TEMPB	7654	5261	JMP EXIT
7614	4244		JMS READ	7655	6012	RRB
7615	3272		DCA TEMPB	7656	0276	AND K77
7616	1270		TAD TEMPB	7657	1271	TAD TEMPB
7617	7420		SNL	7660	5644	JMP I READ
7620	5237		JMP C	7661	1274	EXIT TAD CKSUM
7621	3273		DCA CA	7662	7041	CIA
7622	1270	B,	TAD TEMPB	7663	1270	TAD TEMPB
7623	0276		AND K77	7664	7440	SZA
7624	3271		DCA TEMPB	7665	7402	HLT
7625	1270		TAD TEMPB	7666	7300	CLA CLL
7626	7012		RTR			
7627	7012		RTR	7667	5700	JMP I R200
7630	7012		RTR	7670	0000	TEMPA, 0
7631	0277		AND K177	7671	0000	TEMPB, 0
7632	1271		TAD TEMPB			
7633	1274		TAD CKSUM	7672	0000	TEMPC, 0
7634	3274		DCA CKSUM	7673	0000	CA, 0
7635	1272		TAD TEMPB			
7636	5205		JMP A	7674	0000	CKSUM, 0
7637	3673	C,	DCA I CA	7675	0040	K40 0040
7640	2273		ISZ CA	7676	0077	K77, 0077
				7677	0177	K177, 0177
				7700	0200	R200, 0200

COMPANY CONFIDENTIAL

Title TYPESETTING RIM AND BINARY LOADER (Continued)					Tech Tip Number TYPSET-TT-3 SFWRS	
All Processor Applicability			Author J. Gleeson	Rev 0		Cross Reference
Approval W. Cummins			Date 7-31-72			

SIMPLIFIED FLOW CHART

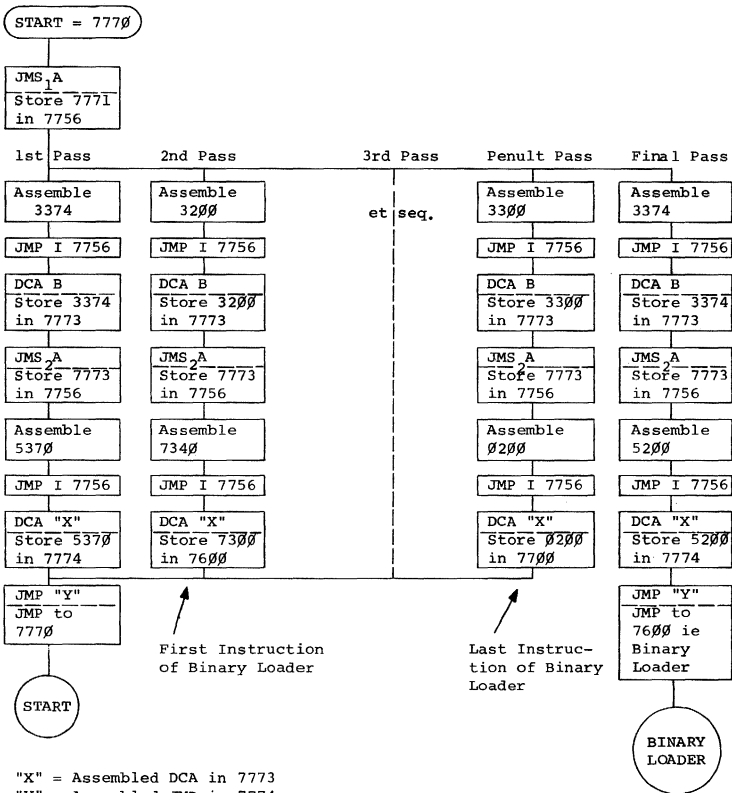

"X" = Assembled DCA in 7773
 "Y" = Assembled JMP in 7774

COMPANY CONFIDENTIAL

CPL

digital	FIELD SERVICE TECHNICAL MANUAL				Option or Designator TYPESET SOFTWARE
	12 Bit <input checked="" type="checkbox"/>	16 Bit <input checked="" type="checkbox"/>	18 Bit <input type="checkbox"/>	36 Bit <input type="checkbox"/>	

Title BOOTSTRAP LOADER - TC01/Disk or Non-Disk				Tech Tip Number	TYPSET SFTWRE-TT-4
All 8's	Processor Applicability		Author P. Hart	Rev 0	Cross Reference
	/ s		Approval W. Cummins	Date 7-31-72	

It may be either desirable or necessary to get the typesetting program started without the use of a bootstrap tape. The TC01 Disk or Non-Disk loader can be toggled in as follows:

Address	Contents	Address	Contents
7730	6774	7742	6766
7731	1347	7743	3354
7732	4341	7744	6771
7733	7240	7745	5344
7734	1353	7746	5741
7735	3355	7747	4600
7736	1352	7750	0000
7737	4341	7751	0000
7740	5753	7752	4220
7741	0000	7753	7400

When these instructions have been correctly deposited, load address 7730 and press START; the Teletype will print out "Select Program to be loaded".

Title BOOTSTRAP LOADER - 552/Disk or Non-Disk				Tech Tip Number	TYPSET SFTWRE-TT-5
All 8's	Processor Applicability		Author P. Hart	Rev 0	Cross Reference
	/ s		Approval W. Cummins	Date	

The 552/Disk or Non-Disk loader can be toggled in as follows:

Address	Contents	Address	Contents
7730	1347	7743	4351
7731	6757	7744	5745
7732	4351	7745	7400
7733	4351	7746	0022
7734	1346	7747	0430
7735	6756	7750	0000
7736	4351	7751	0000
7737	1345	7752	6761
7740	6766	7753	5352
7741	4351	7754	6772
7742	6756	7755	5751

When these instructions have been correctly deposited, load address 7730 and press START; the Teletype will print out "Select Program to be loaded".

Title PA63/PA68F Typesetting Configuration Tests						Tech Tip Number	TYPSET SFTWRE-TT-6
Processor Applicability						Author p. Bezeredi	Rev 0
All 8's	1/3				Approval W. Cummins	Date 7-31-72	Cross Reference

An apparent problem has occurred when running program 01 of the family of 8 Typesetting Configuration Tests (Maindec-08-D2HC) on the PA63/PA68F controller. The problem occurs when a PCF (6022) is issued after a PLS (6026) causing the punch to hand up on a PSF (6021). This is due to the fact that the PLS sets the punch flag, the punch active F/F, and loads the buffer and punches, and the PCF clears the punch flag, the punch active F/F, and clears the punch buffer causing the PSF not to skip. This pseudo problem is caused by the M710 punch control module clearing out the punch active flip-flop when a PCF is issued. THIS IS NOT A HARDWARE PROBLEM!!

Program example:

```

LOOP, CLA CMA           /-to AC
  PLS                   /set and punch
  PCF                   /clear out flag and active F/F
  PSF                   /skip if flag set
  JMP.-1                /no flag-punch will hang here
  JMP LOOP              /we will never get here

```

Title SYSTEM EXERCISER (Old Version - Maindec-08-D7A0)						Tech Tip Number	TYPSET SFTWRE-TT-7
Processor Applicability						Author J. Gleeson	Rev 0
All 8's	1/3				Approval W. Cummins	Date	Cross Reference

Patch for 50 Cycle and PA68F, PA63 Controls

It has been found that the 1 second delay time-out in the System Exerciser is too short for 50 cycle punches and also all punches used with the PA68F and PA63 controls. This condition can be present when the Exerciser prints the message EOVS1 PUNCH 0000 NO RESPONSE. In order to make the time-out delay compatible with all systems, the delay has to be changed to 3 seconds.

- To make the patch, first load the overlay that is to be used.
- Stop the computer and made the following patch:
 If OV0S1 is used change location 2456 from 5664 to 2110
 If OV1S1 is used change location 2661 from 5664 to 2110
 If OV3S1 is used change location 2661 from 5664 to 2110
- Load Address 200 and Start, then type CTRL/C.
- The Exerciser is now ready for commands.

CPL

digital	FIELD SERVICE TECHNICAL MANUAL				Option or Designator
	12 Bit <input checked="" type="checkbox"/>	16 Bit <input checked="" type="checkbox"/>	18 Bit <input type="checkbox"/>	36 Bit <input type="checkbox"/>	TYPESET SOFTWARE

Title RESTORING TYPESET LOADERS FROM LIBRARY SYSTEM				Tech Tip Number	TYPSET SFTWRE-TT-8
All Processor Applicability		Author J. Gleeson	Rev 0	Cross Reference	
8's	11's	Approval W. Cummins	Date 7-31-72		

A situation may arise on installation of a typesetting system where a copy of the "Loader" program may not be available to copy onto the customers LIBRARY SYSTEM tape.

A "Loader" program can be put on the customers tape by toggling in the following program, then using "UPDATE" to load it on the customers tape. The START ADDRESS should be specified as 0200.

- 0200/ 7200
- 1/ 1215
- 2/ 3010
- 3/ 1216
- 4/ 3011
- 5/ 1217
- 6/ 3012
- 7/ 1410
- 10/ 3411
- 11/ 2012
- 12/ 5207
- 13/ 5614
- 14/ 7730
- 15/ 217
- 16/ 7727
- 17/ 7735

COMPANY CONFIDENTIAL

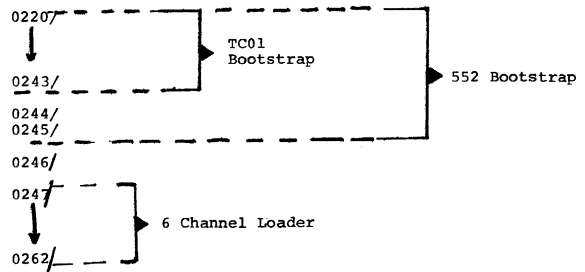

Title TYPESETTING BOOTSTRAP LOADERS						Tech Tip TYPSET	
						Number SFTWRE-TT-9	
Processor Applicability			Author		Rev 0		Cross Reference
All 8's	11's		Approval W. Cummins	Date 7-31-72			

The bootstrap loaders for both 552 and TC01 have been translated so that bootstrap tapes can be prepared easily on site with any TTS perforator. A sequential typing of the following characters will punch a tape with the indicated octal codes and the result will be a bootstrap loader tape.

552 Bootstrap Loader (Disk and Non-Disk Systems)

OCTAL

J	26	J	26	J	26	J	26
7	17	8	15	U	16	U	16
I	14	8	15	3	03	ADD THIN	11
F	32	EN SPACE	35	N	30	RETURN	20
7	17	U	16	U	16	TAPE FEED	00
SPACE BAND	10	U	16	ADD THIN	11	TAPE FEED	00
J	26	J	26	J	26	J	26
8	15	8	15	U	16	U	16
SPACE BAND	10	U	16	ELEVATE	04	S	12
D	22	N	30	QUAD LEFT	33	EN SPACE	35
U	16	U	16	U	16	7	17
\$	07	ADD THIN	11	PF-LM	05	THIN	01
J	26	J	26	J	26	J	26
8	15	8	15	U	16	U	16
ADD THIN	11	7	17	PF-LM	05	EM SPACE	13
EN SPACE	35	D	22	QUAD RIGHT	37	F	32
U	16	U	16	TAPE FEED	00	U	16
7	17	PF-LM	05	TAPE FEED	00	S	12
J	26	J	26	J	26	J	26
8	15	U	16	U	16	U	16
S	12	TAPE FEED	00	A	06	I	14
N	30	EN SPACE	35	RETURN	20	EN SPACE	35
U	16	7	17	THIN	01	7	17
ADD THIN	11	A	06	E	02	S	12
J	26	J	26	J	26	J	26
8	15	U	16	U	16	U	16
EM SPACE	13	THIN	01	\$	07	8	15
N	30	N	30	"	21	QUAD LEFT	33
U	16	U	16	THIN	01	U	16
ADD THIN	11	ADD THIN	11	SP BAND	10	ADD THIN	11
J	26	J	26	J	26	J	26
8	15	U	16	U	16	7	17
I	14	E	02	SP BAND	10	I	14
D	22	EN SPACE	35	RETURN	20	F	32
U	16	U	16	TAPE FEED	00	8	15
A	06	U	16	TAPE FEED	00	SPACE BAND	10

COMPANY CONFIDENTIAL

Title FOTOTRONIC PUNCH ALLOTING					Tech Tip Number TYPSET SPTWRE-TT-10	
All 8's//S	Processor Applicability			Author Doug DeBarge	Rev \emptyset	Cross Reference
				Approval W. Cummins	Date 7-31-72	

A standard allotting scheme has been instituted for systems which include 8 level punches for Fototronic program output.

Configuration	Punch \emptyset	Punch 1	Punch 2	Punch 3	Punch 4-17
only two punches on system	6 level	8 level	N/A	N/A	N/A
one punch output for Fototronic	6 level	8 level	6 level	6 level	6 level
two punch out- puts for Foto- tronic	6 level	8 level	6 level	8 level	6 level

COMPANY CONFIDENTIAL

digital	FIELD SERVICE TECHNICAL MANUAL				Option or Designator
	12 Bit <input checked="" type="checkbox"/>	16 Bit <input checked="" type="checkbox"/>	18 Bit <input type="checkbox"/>	36 Bit <input type="checkbox"/>	TYPESSET SOFTWARE

Title READING FOTOTRONIC 1200 TAPES				Tech Tip Number	TYPESSET SFTWRE-TT-11
All 8's	Processor Applicability	Author John Gleeson	Rev β	Cross Reference	
//S		Approval W. Cummins	Date 7-31-72		

1. INTRODUCTION

The purpose of this Tech Tip is to enable the user to read computer output tapes accepted by the Fototronic 1200 photo-composition machine.

2. TAPE FORMAT

When referencing octal values, binary values and bits, the tape is held as shown:

```

0 0 0 0 0 0 0 0 0
      o
      o
1 2 3 4 5 0 6 7 8 Fototronic Bit #
      o
MSD          o      LSD   DEC Octal Values
0          0 0 0 0 0 0 Example: 233

```

3. DISK/RING SELECTION

Octal codes for disk/ring selection are:

Disk	1	2	3	4	5
Code	$\emptyset 61$	$\emptyset 51$	$\emptyset 45$	$\emptyset 43$	$\emptyset 55$

Inner Ring = $2\emptyset 5$; Outer Ring = $2\emptyset 3$

4. POINT SIZE SELECTION

Point size selection needs two frames of tape. The first frame is the Auto Point Size Code (A.P.S.C.) = 31. The second frame contains the point size value as follows:

Fototronic Bit #	1	2	3	4	5	0	6	7	8
Point Size Value	1/2	1	2	4	8	0	16	32	64

Examples:	<u>1st</u>	<u>2nd</u>	=	<u>Point Size</u>
	31	$36\emptyset$	=	7 1/2
	31	$\emptyset 22$	=	36

Title READING FOTOTRONIC 1200 TAPES (Continued)						Tech Tip Number	TYPSET SFTWRE-TT-11			
All	Processor Applicability					Author	Gleeson/Walker	Rev	0	Cross Reference
8's	115					Approval	W. Cummins	Date	7-31-72	

5. END OF LINE

Each line ends with an EOL group containing six (6) codes. The first code is the EOL Type and has the following significance:

<u>Code</u>	<u>Type</u>	<u>Function</u>
121	Accept	Causes the Fototronic to justify the line.
123	Accept	As code 121 but Fototronic will lead the specified amount in "reverse".
111	Reject	Causes the Fototronic to ignore the line.
141	Multi-Just	Causes the Fototronic to ignore leading and carriage return, so that the next line begins immediately after the line just finished.
1Ø5	Non-Justify	Causes the Fototronic to flush left the line. Replaces JWS codes with a fixed space (12 units).
1Ø7	Non-Justify	As code 1Ø5, but Fototronic will lead the specified amount in "reverse".

The remaining five (5) frames contain information for the Fototronic to "LEAD" and justify the line.

6. LEADING

Leading information is contained in the two (2) frames immediately following the EOL code. The first frame contains the number of 1/4 pts as follows:

Fototronic Bit #	5	6
Points	1/4	1/2

Examples: ØØØ = No 1/4 points
 Ø1Ø = 1/4 points
 ØØ4 = 1/2 points
 Ø14 = 3/4 points

COMPANY CONFIDENTIAL

PAGE 806	PAGE REVISION 0	PUBLICATION DATE July 1972
----------	-----------------	----------------------------

digital	FIELD SERVICE TECHNICAL MANUAL				Option or Designator
	12 Bit <input checked="" type="checkbox"/>	16 Bit <input checked="" type="checkbox"/>	18 Bit <input type="checkbox"/>	36 Bit <input type="checkbox"/>	TYPSET SOFTWARE

Title READING FOTOTRONIC 1200 TAPES (Continued)				Tech Tip Number	TYPSET SFTWRE-TT-11
All Processor Applicability	Author	Gleeson/Walker	Rev	0	Cross Reference
8's //s	Approval	W. Cummins	Date	7-31-72	

6. LEADING (Continued)

The second frame contains the number of full points as follows (bits 7 and 8 are not used):

Fototronic Bit #	1	2	3	4	5	o	6
Points	1	2	4	8	16	o	32

Examples: 35 points = 3Ø4
 24 points = Ø3Ø
 11 points = 32Ø

7. JUSTIFICATION

The remaining three (3) frames in the EOL group contain the necessary information for the Fototronic to justify the line.

Each interword space in the line contains a JWS code (241). The first of these three (3) frames contains a 6 bit count of the number of JWS's used in the line, as follows (the count is the # of JWS's-1):

377 = Ø JWS's	1ØØ = 3 JWS's
ØØØ = 1 JWS	
2ØØ = 2 JWS's	374 = 64 JWS's

The 1200 program calculates the total amount of space used up by characters and fixed spacing on the line, and then subtracts it from the overall column measure. This remainder is then output to the Fototronic in the last two (2) frames of the EOL group.

The first frame is a 6 bit count of the number of piclets (see column measure) remaining. The code output is the number of piclets minus 1.

Examples: ØØØ = 1 piclet
 2ØØ = 2 piclets
 374 = 64 piclets

The second frame is a true 6 bit count of the number of picas remaining.

ØØØ = no picas
2ØØ = 1 pica
374 = 63 picas

Title						Tech Tip TYPSET				
READING FOTOTRONIC 1200 TAPES (Continued)						Number SFTWRE-TT-11				
All 8's	Processor Applicability					Author	John Gleeson	Rev	0	Cross Reference
	/s					Approval	W. Cummins	Date	7-31-72	

7. JUSTIFICATION (Continued)

The Fototronic uses these last three (3) frames of information to calculate the amount of interword spacing required for the line; unlike other photo-comp., machines which require the program to output the exact amount of spacing desired.

8. COLUMN MEASURE

As stated above, the Fototronic requires the remainder of the measure to be output in piclets and picas, where a piclet is 1/64 of a pica.

This remainder can be calculated as follows (assume one point size used for the line):

- Calculate the total amount of relative units used for all of the characters and fixed spacing on the line.
- Apply the formula:-

$$\frac{\text{Total Relative Units} \times 2X \text{ point size}}{12} = \frac{\text{Total Piclets Used}}{\text{Piclets Used}}$$

- Divide by 64 to find picas and piclets and subtract from the overall column measure.

Note that two (2) picas remainder would be output as 64 piclets and 1 pica.

Also note that where point sizes are mixed within a line, the calculation has to be performed for individual characters.

9. SKIPTAPE CODE

The SKIPTAPE cost $\text{\textcircled{7}}$ acts like a rub-out and causes no action in the Fototronic. It has the following functions:

- The minimum length of coded information between EOL sequences must be nineteen (19) codes. At the beginning of the tape this is achieved by using SKIPTAPE codes.
- Successive lines are brought up to the nineteen (19) minimum by using combinations of $\text{\textcircled{7}}$ and 377 (rub-out).

COMPANY CONFIDENTIAL

PAGE 808	PAGE REVISION 0	PUBLICATION DATE July 1972
----------	-----------------	----------------------------

digital	FIELD SERVICE TECHNICAL MANUAL				Option or Designator
	12 Bit <input checked="" type="checkbox"/>	16 Bit <input checked="" type="checkbox"/>	18 Bit <input type="checkbox"/>	36 Bit <input type="checkbox"/>	TYPESET SOFTWARE

Title READING FOTOTRONIC 1200 TAPES (Continued)				Tech Tip Number	TYPESET SFTWRE-TT-14
All	Processor Applicability		Author Walker/Gleeson	Rev \emptyset	Cross Reference
8's // 's			Approval W. Cummins	Date 7-31-72	

Quadded lines are achieved as follows:

- a. Quad Left - Line is output with a NON-JUST EOL group. Fixed spaces are output for interword spacing. The NON-JUST EOL causes the Fototronic to ignore justification information.
- b. Quad Right - Line is output with one JWS before the text. Fototronic will then replace this space with the full amount of space remaining.
- c. Quad Centre - Similar to Quad Right except the space remaining, output in the EOL group, is 1/2 the true amount.

11. OTHER FUNCTIONS

<u>Code</u>	<u>Function</u>
\emptyset 25	Cut Film - used to cut the film at any desired point, but must not appear in the middle of a line.
\emptyset 13	Kern - used to reduce the escapement of a character. Following the character to be kerned (which always escapes its full amount), the kern code is placed in the tape. This causes the carriage to reverse direction. The kern code is followed by a code containing a true count of the number of 1/32 EM spaces to Kern (example 3 \emptyset - 3/32 EM). This code is then followed by the kern code again, which switches the carriage to the forward direction.
\emptyset 15	Monitor Stop - causes the Fototronic to stop reading tape.
\emptyset 23	Leader Insert - causes the Fototronic to switch to the leader window. Monitor action is required to restart and flash the character; if stop code is output.
211	Non-Space - this causes the following character to be flashed but not escaped (used for accents, etc.)
221	Tab - this causes the carriage to advance to the next 1/2 pica position. Used for spacing out in Tabular setting without flashing fixed spaces.

Title READING FOTOTRONIC 1200 TAPES (Continued)					Tech Tip Number	TYPESET SFTWRE-TT-11	
All	Processor Applicability				Author Gleeson/Walker	Rev 0	Cross Reference
8's	/s				Approval W. Cummins	Date 7-31-72	

12. FOTOTRONIC CODES (Grouped)

a.	2ØØ	Ø	Ø56	JWS	241
b.	1ØØ	1	1Ø6	EM	376
c.	3ØØ	2	Ø46	EN	176
d.	Ø4Ø	3	146	FIGURE	276
e.	24Ø	4	Ø26	FIXED	Ø76
f.	14Ø	5	126	THIN	336
g.	34Ø	6	Ø66	1/32 EM	136
h.	Ø2Ø	7	166		
i.	22Ø	8	Ø16	Disk 1	61
j.	12Ø	9	116	Disk 2	51
k.	22Ø			Disk 3	45
l.	Ø6Ø	.	33Ø	Disk 4	43
m.	26Ø	,	Ø7Ø	Disk 5	55
n.	16Ø	-	17Ø	Outer Ring	2Ø3
o.	36Ø	;	37Ø	Inner Ring	2Ø5
p.	Ø1Ø	:	374		
q.	21Ø	!	174	EOL ACCEPT	121
r.	11Ø	¢	ØØ4	EOL REJECT	111
s.	31Ø	›	2Ø6	EOL MULTI-JUST	141
t.	Ø5Ø	(156	EOL NON-JUST	1Ø5
u.	25Ø)	356		
v.	15Ø	?	27Ø	A.P.S.C.	Ø31
w.	35Ø	§	Ø36	MONITOR	Ø15
x.	Ø3Ø			SKIPTAPE	ØØ7
y.	23Ø			KERN	Ø13
z.	13Ø			CUT FILM	Ø25

PAGE 810	PAGE REVISION 0	PUBLICATION DATE July 1972
----------	-----------------	----------------------------

COMPANY CONFIDENTIAL

digital	FIELD SERVICE TECHNICAL MANUAL				Option or Designator
	12 Bit <input checked="" type="checkbox"/>	16 Bit <input checked="" type="checkbox"/>	18 Bit <input type="checkbox"/>	36 Bit <input type="checkbox"/>	TYPSET SOFTWARE

Title	READING FOTOTRONIC 1200 TAPES (Continued)			Tech Tip Number	TYPSET SFTWRE-TT-11
All	Processor Applicability	Author	Gleeson/Walker	Rev	g
8's	/s	Approval	W. Cummins	Date	7-31-72
					Cross Reference

12. FOTOTRONIC CODES (Continued)

NON-SPACE 211

TAB 221

Upper case codes are
lower case plus $\beta\beta 4$ (bit 6)

Small cap codes are
lower case plus $\beta\beta 2$ (bit 7)

Bits 6 and 7 added to lower
case code indicates figure,
WD space or ligature.

Title READING FOTOTRONIC 1200 TAPES (Continued)						Tech Tip Number	TYPSET SFTWRE-TT-11	
All	Processor Applicability					Author	Gleeson/Walker	Rev g
8's						Approval	W. Cummins	Date 7-31-72
								Cross Reference

13. FOTOTRONIC CODES (Numerical Order)

ØØ4	6	112	R*	232	Y*
ØØ7	SKIPTAPE	114	R	234	Y
Ø1Ø	p	116	9	24Ø	e
Ø12	P*	12Ø	j	241	JWS
Ø13	KERN	121	EOL ACCEPT	242	E*
Ø14	P	122	J*	244	E
Ø15	MONITOR	123	EOL ACCEPT,	25Ø	u
Ø16	Ø		with reverse	252	U*
Ø2Ø	h		lead	254	U
Ø22	H*	124	J	26Ø	m
Ø24	H	126	5	262	M*
Ø25	CUT FILM	13Ø	z	264	M
Ø26	4	132	Z *	270	?
Ø3Ø	x	134	Z	276	FIGURE SPACE
Ø31	A.P.S.C.	136	1/32 EM	3ØØ	c
Ø32	X*	140	f	3Ø2	C*
Ø34	X	141	EOL Multi-	3Ø4	C
Ø36	\$		JUST	31Ø	s
Ø4Ø	d	142	F*	312	S*
Ø42	D*	144	F	314	S
Ø43	Disk 4	146	3	320	k
Ø44	D	15Ø	v	322	K*
Ø45	Disk 3	152	V*	324	K
Ø46	2	154	V	33Ø	.
Ø5Ø	t	156	(336	THIN
Ø51	Disk 2	16Ø	n	34Ø	g
Ø52	T*	162	N*	342	G*
Ø54	T	164	N	344	G
Ø55	Disk 5	166	7	35Ø	w
Ø56	Ø	17Ø	-	352	W*
Ø6Ø	l (lower case L)	174	!	354	W
Ø61	Disk 1	176	EN	356]
Ø62	L*	2ØØ	a	36Ø	o
Ø64	L	2Ø2	A*	362	O*
Ø66	6	2Ø3	OUTER RING	364	O
Ø7Ø	,	2Ø4	A	37Ø	;
Ø76	FIXED SPACE	2Ø5	INNER RING	374	:
1ØØ	b	2Ø6	'	376	EM
1Ø2	B*	21Ø	q		
1Ø4	B	211	NON-SPACE		
1Ø5	EOL NON-JUST	212	O*		
1Ø6	l	214	Q		
1Ø7	EOL NON-JUST,	220	i		
	with reverse	221	TAB		
	lead	222	I*		
11Ø	r	224	I		
111	EOL REJECT	23Ø	y		

COMPANY CONFIDENTIAL

Title READING FOTOTRONIC 1200 TAPES (Continued)						Tech Tip TYPSET			
						Number SFTWRE-TT-11			
All		Processor Applicability		Author Gleeson/Walker		Rev 0		Cross Reference	
8's		11's		Approval W. Cummins		Date 7-31-72			

14. EOL GROUP EXAMPLES (continued)

b.

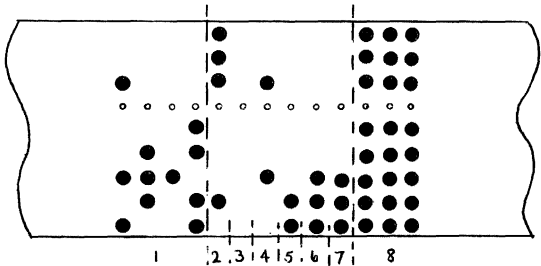

1. Part of preceding text = E n d .
2. Code 107 = EOL NON-JUST Group with reverse lead
3. # of 1/4 points to reverse lead = 0
4. # of full points to reverse lead = 36
5. # of JWS's used in line = 4. Since this is a NON-JUST line, these will be replaced with fixed spaces (12 units)
6. # of pictets remaining in line = 8
7. # of picas remaining in line = 7
8. Rub-out codes.

COMPANY CONFIDENTIAL

PAGE 814	PAGE REVISION 0	PUBLICATION DATE July 1972
----------	-----------------	----------------------------

digital	FIELD SERVICE TECHNICAL MANUAL				Option or Designator
	12 Bit <input type="checkbox"/>	16 Bit <input checked="" type="checkbox"/>	18 Bit <input type="checkbox"/>	36 Bit <input type="checkbox"/>	TYPESSET SOFTWARE

Title	PHOTON 560 INPUT TAPES	Tech Tip Number	TYPSET SFTWRE-TT-12
All	Processor Applicability	Author J. GLEESON	Rev 0
8'd11		Approval G. CHAISSON	Date 02/02/73
			Cross Reference

1. INTRODUCTION

The purpose of this tech tip is to enable the user to read computer output tapes accepted by the Photon 560 photo-composition machine. An understanding of the Photon code structure is helpful when trying to determine if a bad output from the 560 is due to Photon malfunction or Typeset-8 malfunction.

2. TAPE FORMAT

The Photon 560 utilizes a 16 bit code structure but is able to accept "multi-frame" 6 or 8 level paper tape input. The frames are broken down into "First Frame codes" and "Second Frame Codes".

"First Frame Codes" are given letter assignments for each hole and are used for machine set-up, selection of disk characters, etc. "Second Frame Codes" are given binary assignment for each hole and are used for Leading, Escapement and Point Size values and Type Face Selection.

Eight level input requires two frames of information and 6 level requires three (see Figures 1 and 2). Because of the overlap of "First Frame Codes" and "Second Frame Codes" in the middle frame of 6 level input it is difficult to represent machine functions in octal, hence letter and binary assignments are used in the tables.

3. SYNCHRONIZING CODE HOLE

A synchronizing code hole (Z) always appears in the low order bit of the second frame. A block of Text following a tape feed must always be preceded by either a minimum of one Z (8 level) or by 2 Z codes (6 level).

COMPANY CONFIDENTIAL

Title PHOTON 560 INPUT TAPES (Continued)						Tech Tip Number	TYPESET SFTWRE-TT-12
All	Processor Applicability				Author J. Gleeson	Rev 0	Cross Reference
8's	11				Approval G. Chaisson	Date 02/02/73	

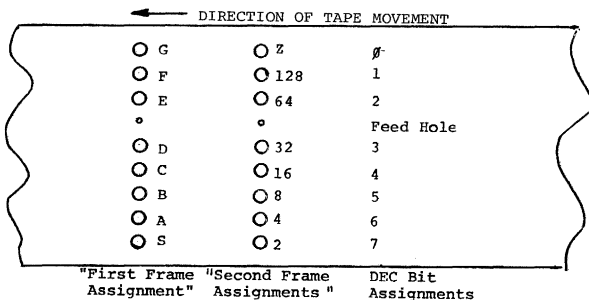

FIGURE 1 TWO FRAME - 8 LEVEL TAPE FORMAT

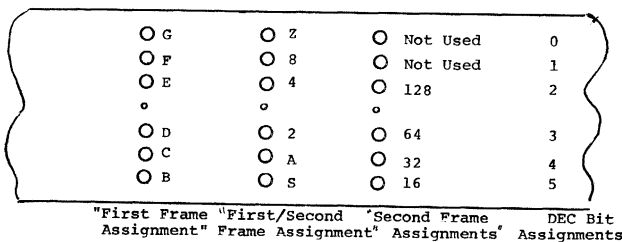

FIGURE 2 THREE FRAME - 6 LEVEL TAPE FORMAT

COMPANY CONFIDENTIAL

digital	FIELD SERVICE TECHNICAL MANUAL				Option or Designator
	12 Bit <input checked="" type="checkbox"/>	16 Bit <input checked="" type="checkbox"/>	18 Bit <input type="checkbox"/>	36 Bit <input type="checkbox"/>	TYPSET SOFTWARE

Title PHOTON 560 INPUT TAPES (Continued)				Tech Tip Number	TYPSET SFTWRE- TT-12
All	Processor Applicability			Author J. Gleeson	Rev 0
8's	11			Approval G. Chaisson	Date 02/02/73
					Cross Reference

4. LARGER POINT SIZES

4.1 8 Level Input

Text of 18 and 24 point size must be preceded by the "Width Doubling Code" (S,E,F). The "Normalize" code (S,E) is used when returning to small point sizes.

Sizes of 30 to 42 utilize a total of six frames for each character to be flashed. The first group contains an identity code and one third of the width. The second and third group each contain one third of the width.

Text of 48 - 72 points must be preceded by the "Width Doubling Code". Eight frames are used for each character. The first group contains an identity code, and one third of the width. The third and fourth groups each contain one third of the width.

4.2 6 Level Input

As for the 8 level input except that since a "group" is three frames instead of two, point sizes 30-42 require nine frames per character and sizes 48-72 require twelve frames.

5. STORED LEADING

Binary assignment values have the following significance.

Binary Assignment	2	4	8	16	32	64	128
Leading (Points)	1	2	4	8	16	32	None

Note that the doubling circuit must be in NORMALIZED condition when reading stored lead information.

6. MACHINE FUNCTION CODES

6.1 Disk Level (Typeface)

1	S,C,F,G	9	S,C,D,F,G
2	S,C,E,G	10	S,C,D,E,G
3	S,C,G	11	S,C,D,G
4	S,C,E,F	12	S,C,D,E,F
5	S,C,F	13	S,C,D,F
6	S,C,E	14	S,C,D,E
7	S,C	15	S,C,D
8	S,C,E,F,G	16	S,C,D,E,F,G

COMPANY CONFIDENTIAL

Title PHOTON 560 INPUT TAPES (Continued)										Tech Tip TYPSET	
										Number SFTWRE-TT-12	
All		Processor Applicability				Author J. Gleeson		Rev 0		Cross Reference	
8's		11				Approval G. Chaisson		Date 02/02/73			

6. MACHINE FUNCTION CODES (Continued)

6.2 Lens Shift (Point Size)

Location	1	S,B,E	7	S,B,D,F
	2	S,B,F	8	S,B,C,E,F
	3	S,B,E,F	9	S,B,D,E,G
	4	S,B,G	10	S,B,C
	5	S,B,E,G	11	S,B,C,D
	6	S,B,D,E	12	S,B,C,D,G

6.3 Leading

Stored Lead	- S,A	plus value of Leading (See 5)
Add Lead	S,A,D,E	= 1 point
	S,A,D,F	= 2 points
	S,A,D,E,F	= 4 points
	S,A,D	= 8 points
Reverse Lead	S,D,F	
Zero Lead	S,A,F	

6.4 PI MAT

Position	1	S,A,G	5	S,A,D,G
	2	S,A,B,G	6	S,A,B,D,G
	3	S,A,C,G	7	S,A,C,D,G
	4	S,A,B,C,G	8	S,A,B,C,D,G

6.5 Fixed Spaces

<u>Inches</u>	<u>Bin. Assignment</u>
0.1	128
0.05	64
0.025	32
0.0125	16
0.00625	8
0.00312	4
0.00156	2

6.6 Miscellaneous

Stop Code	S,A
End Of Line	S,A,C
Zero Set Character	Identity Code Only
Non-Photo	" Width Code Only
Double Set	S,E,F (See 4)
Single Set	S,E
Multi-Just	S,A,B,C
Film Punch	S,D

COMPANY CONFIDENTIAL

DIGITAL EQUIPMENT CORPORATION

digital	FIELD SERVICE TECHNICAL MANUAL				Option or Designator
	12 Bit <input checked="" type="checkbox"/>	16 Bit <input checked="" type="checkbox"/>	18 Bit <input type="checkbox"/>	36 Bit <input type="checkbox"/>	TYPESSET SOFTWARE

Title PHOTON 560 INPUT TAPES (Continued)				Tech Tip Number	TYPSET SFTWRE-TT-12
All Processor Applicability		Author J. Gleeson	Rev -0-	Cross Reference	
8's	11	Approval G. Chaisson	Date 02/02/73		

7. CHARACTER CODES

Disk Position	U.C. Character	Disk Position	L.C. Character	CODE
1	Plus +	46	Equal =	B,D,E,F
2	Colon :	47	S.Colon ;	D,E,F,G
3	ffi	48	fi	C,D,E,F
4		49	ff	B,C,D,E
5	ff	50	fi	C,D,E
6	V.Bar	51	F. Bar /	D,F,G
7)	52	Zero Ø	B,F,G
8	(53		C,F,G
9	Unquote	54		B,E,G
10	&	55		D,E,G
11	*	56		C,E,G
12	%	57		B,D,C
13	\$	58		C,D,G
14	Dagger	59		B,C,G
15	Hyphen -	60		D,E,F
16	?	61		B,E,F
17	Dash	62	Half Dash	C,E,F
18	Exclm.	63	Comma	B,D,F
19	Quote	64	Period	C,D,F
20	Z	65	z	B,C,F
21	Q	66	q	B,D,E
22	J	67	j	E,F,G
23	K	68	k	B,C,E
24	X	69	x	B,C,D
25	W	70	w	B,G
26	V	71	v	C,G
27	Y	72	y	B,F
28	B	73	b	D,G
29	G	74	g	C,E
30	C	75	c	B,E
31	U	76	u	E,G
32	P	77	p	D,F
33	H	78	h	C,E
34	D	79	d	B,D
35	M	80	m	F,G
36	L	81	l	E,F
37	S	82	s	D,E
38	F	83	f	C,D
39	N	84	n	B,C
40	R	85	r	G
41	O	86	o	F
42	I	87	i	E
43	A	88	a	D
44	T	89	t	C

COMPANY CONFIDENTIAL

Title PHOTON 560 INPUT TAPES (Continued)						Tech Tip Number		TYPSET SFTWRE-TT-12		
All 8's 11		Processor Applicability				Author J. Gleeson		Rev 0		Cross Reference
						Approval G. Chaisson		Date 02/02/73		

7. CHARACTER CODES (Continued)

<u>Disk Position</u>	<u>U.C. Character</u>	<u>Disk Position</u>	<u>L.C. Character</u>	<u>CODE</u>
45	E	89	t	C

8. EXAMPLES

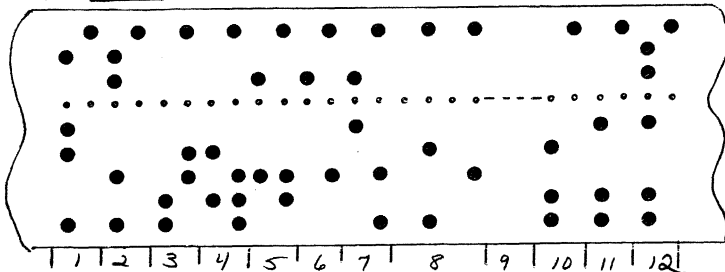

FIGURE 3 - EXAMPLE OF EIGHT LEVEL INPUT

1. Type Face 13
2. Point Size 12 (lens Position 3)
3. Leading 12 points
4. T width of 14 units
5. h width of 12 units
6. i width of 8 units
7. s width of 10 units
8. Interword spaces (non-flash) width of 18 units plus width of 4 units
9. Rest of Line
10. EOL Code
11. Add Lead 8 points
12. Add Lead 4 points

DIGITAL EQUIPMENT CORPORATION

COMPANY CONFIDENTIAL

digital	FIELD SERVICE TECHNICAL MANUAL				Option or Designator	
	12 Bit <input checked="" type="checkbox"/>	16 Bit <input checked="" type="checkbox"/>	18 Bit <input type="checkbox"/>	36 Bit <input type="checkbox"/>	TYPESET SOFTWARE	

Title					Tech Tip		TYPSET	
PHOTON 560 INPUT TAPES (Continued)					Number		SFTWRE-TT-12	
Processor Applicability			Author		Rev		Cross Reference	
All	8's		J. Gleeson		0			
11			Approval G. Chaisson		Date 02/02/73			

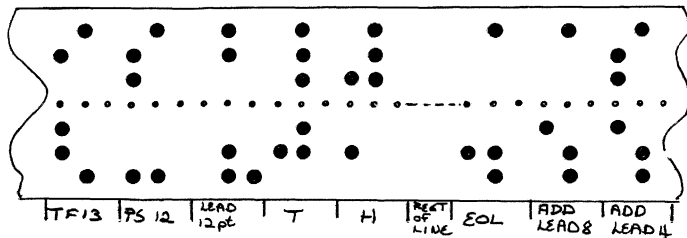

FIGURE 4 EXAMPLE OF 6 LEVEL INPUT

COMPANY CONFIDENTIAL

Title						PHOTON 7000 INPUT TAPES		Tech Tip		TYPSET	
All						Processor Applicability		Author		J. Gleeson	
8's						11		Rev		0	
Approval						G. Chaisson		Date		02/02/73	
										Cross Reference	

1.0 INTRODUCTION

The purpose of this Tech Tip is to enable the user to read computer output tapes accepted by the Photon 7000 photo-composition machine. An understanding of the 7000 code structure is helpful when trying to differentiate between bad output due to 7000 malfunction or bad output due to Typeset 8 (or 11) system malfunction. Note that some of the 7000 functions will not be utilized in Typesetting programs.

2.0 TAPE FORMAT

The Photon 7000 can accept either 8 level or 6 level input tapes. Eight level is based on the hexadecimal system and 6 level on the TFS system. The two forms of input will be explained separately.

3.0 UNITS OF MEASURE

Except as noted, all absolute values for size and spacing are specified in 1/100 points. All relative values are specified in units of 1/100 of an EM.

4.0 EIGHT LEVEL INPUT

4.1 Code Allocation

4.1.1 Zero (Ø) and 377 are used as NO-OP or filler codes. They are ignored by the 7000.

4.1.2 1-200 are used for character codes, allowing 128 characters per font.

4.1.3 201-376 are reserved for function codes. Not all of the codes are used, and if output to the 7000 will cause it to stop.

4.2 Machine Commands

4.2.1 Change Font (FØ) - must be followed by the binary number of the font to be used.

4.2.2 Set Horizontal Size (F1) - Followed by two frames giving the value of the horizontal size to be set, in abs. units.

4.2.3 Set Vertical Size (F2) - Followed by two frames giving the value of the vertical size, in abs. units.

COMPANY CONFIDENTIAL

DIGITAL EQUIPMENT CORPORATION

digital	FIELD SERVICE TECHNICAL MANUAL				CPI
	12 Bit <input checked="" type="checkbox"/>	16 Bit <input checked="" type="checkbox"/>	18 Bit <input type="checkbox"/>	36 Bit <input type="checkbox"/>	Option or Designator TYPESET SOFTWARE

Title PHOTON 7000 INPUT TAPES (Continued)					Tech Tip Number	TYPSET SFTWRE-TT-13
All	Processor Applicability		Author J. Gleeson	Rev 0	Cross Reference	
8's 11			Approval G. Chaisson	Date 02/02/73		

4.0 EIGHT LEVEL INPUT (Continued)

4.2 Machine Commands (Continued)

- 4.2.4 Set Horizontal and Vertical size (see point size) (F3) - followed by two frames giving both values, in abs. units.
- 4.2.5 Change to Oblique Mode (E9) - changes the output to slanted output.
- 4.2.6 Change to Normal Mode (E8) - Cancels the oblique mode.
- 4.2.7 Vertical Space Absolute (Leading) (C0) - followed by two frames giving the +VE or -VE value in abs. units. 3,276.8 points is the maximum.
- 4.2.8 Vertical Space Relative (C1) - followed by two frames giving the +VE or -VE value in relative units. 3,276.8 units is the maximum.
- 4.2.9 Horizontal Spacing Absolute (C2) - followed by two frames giving the +VE or -VE value in abs. units. Six hundred points (600) is the maximum for a 50 pica line, 840 points for a 70 pica line.
- 4.2.10 Horizontal Spacing Relative (C3) - followed by two frames giving the +VE or -VE value in relative units.
- 4.2.11 Letter Space in 1/4 strokes (C4) - followed by two frames giving the number of "strokes" to add or subtract from the LH bearing of all characters until an LS command with a value of zero is given. There are two "strokes" per unit in 18 point masters four "strokes" per unit in 36 point masters and 8 "strokes" per unit in 72 point masters.
- 4.2.12 Letter Space in units (C5) - Followed by two frames giving the +VE or -VE values in relative units.
- 4.2.13 Store Vertical Space (D0) - followed by two frames giving the value in absolute units.
- 4.2.14 Executive Vertical Space - executes the amount of lead as specified in the Store Vertical Space Command.

COMPANY CONFIDENTIAL

Title PHOTON 7000 INPUT TAPES (Continued)						Tech Tip Number		TYPESET SFTWRE-TT-13		
All		Processor Applicability				Author J. Gleeson		Rev 0		Cross Reference
8's 11						Approval G. Chaisson		Date 02/02/73		

4.0 EIGHT LEVEL INPUT (Continued)

4.2 Machine Commands (Continued)

- 4.2.15 Store Horizontal Space A (DA) - followed by two frames giving the value in relative units.
- 4.2.16 Execute Horizontal Space A (EA) - executes the amount of horizontal space as specified in the Store Horizontal Space A command.
- 4.2.17 Store Horizontal Space B (DB), C (DC) or D (DD) as in 4.2.15.
- 4.2.18 Execute Horizontal Space B (EB), C (EC) or D (ED) as in 4.2.16.
- 4.2.19 Return beam to left margin (E1) - returns the beam to the left margin only.
- 4.2.20 Carriage Return (E2) - return the beam to the left margin and execute stored vertical space.
- 4.2.21 Set tab (D3) - followed by two frames giving the position of the Tab Stop (as measured from the left hand margin) in absolute units.
- 4.2.22 Tab (E3) - moves the beam to the Tab Stop.
- 4.2.23 Tab Carriage Return (E4) - moves the beam to the Tab Stop and executes stored vertical spacing.
- 4.2.24 Set Film Speed (A β) - followed by two frames. The last four bits specify the speed in $\frac{1}{2}$ " per second increments. Minimum is 0001, maximum is 1111 ($7\frac{1}{2}$ "), default is 5".
- 4.2.25 Set Line Length (A1) - followed by two frames specifying the line length in absolute units.
- 4.2.26 Set Oblique Angle (A2) - followed by two frames specifying the binary value of the oblique angle in 1/10 degrees. Minimum is 0, maximum is 45°. Default is 12.5°.
- 4.2.27 Set Resolution (A4) - followed by two frames. If the last two bits of the second frame are 00 or 10, the resolution will be 800 lines/inch (normal). If the bits are 01 or 11, the resolution will be 400 lines/inch (proof mode). Default condition is 800.

digital	FIELD SERVICE TECHNICAL MANUAL				Option or Designator
	12 Bit <input checked="" type="checkbox"/>	16 Bit <input checked="" type="checkbox"/>	18 Bit <input type="checkbox"/>	36 Bit <input type="checkbox"/>	TYPESET SOFTWARE

Title PHOTON 7000 INPUT TAPES (Continued)				Tech Tip Number	TYPSET SFTWRE-TT-13
All	Processor Applicability		Author J. Gleeson	Rev 0	Cross Reference
8's	11		Approval G. Chaisson	Date 02/02/73	

4.0 EIGHT LEVEL INPUT (Continued)4.2 Machine Commands (Continued)

- 4.2.28 Set Retrace (A5) - followed by two frames. The last 3 bits specify the number of retraces of each character. Minimum is 0, maximum is 7, default is 0.
- 4.2.29 Start Job (FA) - followed by two frames giving the job #. The machine will halt and display the job # in the 7000 self-scan display. May continue by hitting the "Proceed" button.
- 4.2.30 Self-Scan Display (FC) - causes the next 16 characters to be displayed. Characters are coded in ASC11 and the high order 2 bits are stripped off, allowing 64 characters.
- 4.2.31 Halt (FD) - causes the 7000 to halt.
- 4.2.32 End of Job (FE)- causes "End of Job" to be displayed on the Self-Scan.

5.0 SIX LEVEL INPUT5.1 Code Allocation

- 5.1.1 0 and 77 are used as NO-OP or FILLER codes.
- 5.1.2 Standard TTS codes define 92 character positions (using shift and unshift). The remaining 36 are accessed by typing the UR code, followed by an alpha-character between A-R (shift or unshift).
- 5.1.3 Machine Commands are either represented by a unique TTS code or by combining the "bell" code with other codes. Of these "bell" commands all but three must be followed by three bytes of information. The high order two bits are redundant.

COMPANY CONFIDENTIAL

Title PHOTON 7000 INPUT TAPES (Continued)				Tech Tip TYPESET	
				Number SFTWRE-TT-13	
All Processor Applicability		Author J. Gleeson		Rev 0	
8 11		Approval G. Chaisson		Date 02/02/73	
Cross Reference					

6.0 FUNCTION CODES

(* = TTS Bell Code)

<u>FUNCTION</u>	<u>HEX</u>	<u>OCTAL</u>	<u>6 LEVEL</u>
Set film speed	AØ	24Ø	* Ø
Set line length	A1	241	* 1
Set oblique angle	A2	242	* 2
Set right/wrong reading output	A3	243	* 3
Set resolution	A4	244	* 4
Set Retrace	A5	245	* 5
Vertical Space Absolute	CØ	3ØØ	* L
Vertical Space Relative	C1	3Ø1	* M
Horizontal Space Absolute	C2	3Ø2	* S
Horizontal Space Relative	C3	3Ø3	* T
Letter Space (½ Strokes)	C4	3Ø4	* U
Letter Space (Units)	C5	3Ø5	
Store Vertical Space	DØ	320	* K
Set Tab	D3	323	* P.F.
Store Horizontal Space "A"	DA	332	* EM
Store Horizontal Space "B"	DB	333	* EN
Store Horizontal Space "C"	DC	334	* THIN
Store Horizontal Space "D"	DD	335	* ADD THIN
Execute Stored Vertical Space	EØ	34Ø	Elevate
Return Beam to Left Margin	E1	341	Space
Carriage Return	E2	342	Return
Tab	E3	343	P.F.
Tab Carriage Return	E4	344	Quad Left
Normal Mode	E8	350	Quad Right
Oblique Mode	E9	351	Quad Centre
Execute Horizontal "A"	EA	352	EM
Execute Horizontal "B"	EB	353	EN
Execute Horizontal "C"	EC	354	THIN
Execute Horizontal "D"	ED	355	ADD THIN
Change Font	FØ	36Ø	* F
Set Horizontal Size	F1	361	* H
Set Vertical Size	F2	362	* V
Set Both (Point Size)	F3	363	* P
Start Job	FA	372	* A
Start Page	FB	373	* B
Self-Scan Display	FC	374	* C
Halt	FD	375	* D
End Job	FE	376	* E

COMPANY CONFIDENTIAL

DIGITAL EQUIPMENT CORPORATION

digital	FIELD SERVICE TECHNICAL MANUAL				Option or Designator
	12 Bit <input checked="" type="checkbox"/>	16 Bit <input checked="" type="checkbox"/>	18 Bit <input type="checkbox"/>	36 Bit <input type="checkbox"/>	TYPESSET SOFTWARE

Title				PHOTON 7000 INPUT TAPES (Continued)		Tech Tip	TYPESSET
						Number	SFTWRE-TT-13
All	Processor Applicability			Author	J. Gleeson	Rev	0
8's	11			Approval	G. Chaisson	Date	02/02/73
							Cross Reference

6.0 FUNCTION CODES (Continued)PRECEDENT CODES:

Precedent code for 18 additional character positions

UPPER RAIL (UR)

Precedent code for commands

Bell Code

NOTE: The precedent code applies to the next code only.
If successive codes require the same precedent code,
each one must be preceded by the precedent code.

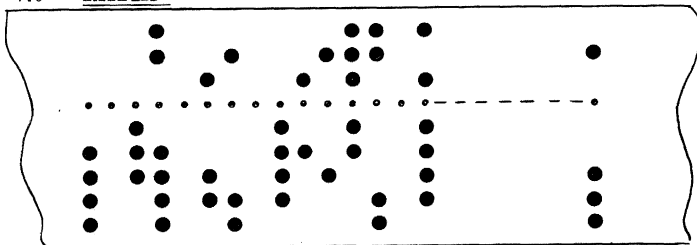
7.0 EXAMPLES

- Change to Font #56 HEX=F0 Ø 38 Octal = 360 Ø 70
- Change to Pt size 10 (100 units) HEX = F3 Ø 64
Octal = 363 Ø 144
- Store Vertical Space 12 pts (120 units) HEX = D0 Ø 78
Octal = 320 Ø 170
- The HEX = 14 22 1F Octal = 24 42 37
- Horizontal Space Relative (125 units) HEX = C3 Ø 7D
Octal = 303 Ø 175
- Carriage Return HEX = E2 Octal = 342

FIGURE 1-8 LEVEL INPUT

COMPANY CONFIDENTIAL

Title						PHOTON 7000 INPUT TAPES (Continued)		Tech Tip Number		TYPSET SFTWRE-TT-13	
All		Processor Applicability				Author		J. Gleeson		Rev 0	
8's		11				Approval		G. Chaisson		Date 02/02/73	
										Cross Reference	

7.0 EXAMPLES (Continued)

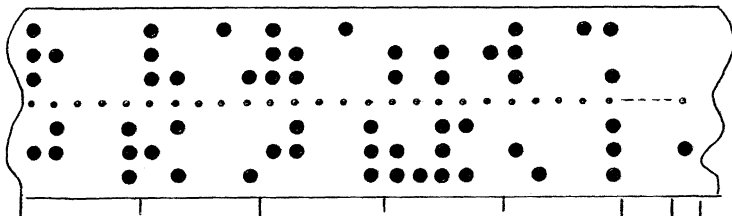

1. Change to Font #56 TTS = * P Ø Ø 7Ø
2. Change to Pt Size (10) TTS = *P Ø 1 44
3. Store Vertical Space (12 pts) TTS = *K Ø 1 7Ø
4. Shift T Unshift h e
5. Horizontal Space Relative (125 units) TTS = *T Ø 1 75
6. Carriage Return TTS = Return (2Ø)

FIGURE 2 - 6 Level Input

Title						ERROR HALTS IN DEC TYPESETTING SOFTWARE		Tech Tip Number		TYPESET SFTWRE-TT-14	
All		Processor Applicability				Author		Fred Miller		Rev 0	
8's		11				Approval		G. Chaisson		Date 02/02/73	
										Cross Reference	

The following list of error halts in DEC Typesetting Software is designed to aid the Field Service Technician at DEC Typesetting installations.

Due to the need to reassemble software for each year, these address locations may change. The change should be small and in this general area.

COMPANY CONFIDENTIAL

digital**FIELD SERVICE TECHNICAL MANUAL**

Option or Designator

12 Bit 16 Bit 18 Bit 36 Bit

TYPESET SOFTWARE

Title ERROR HALTS IN DEC TYPESETTING SOFTWARE

Tech Tip TYPESET
Number SPTWRE-TT-14

All Processor Applicability

Author R. Hartz

Rev A

Cross Reference

8

Approval G. Chaisson Date 5/23/73

HOT METAL SYSTEMS

<u>PROGRAM TITLE</u>	<u>LOCATION</u>	<u>AC CONTENTS</u>	<u>REASON</u>
Basic Bands	1577	Not pertinent	Memory error halt
Basic No-Bands	554	Not pertinent	Memory error halt
Disk System Bands (TCOL)	0611 5204		Illegal Character Disk Error Halt
Disk System No-Bands (TCOL)	0611 5204		Illegal Character Disk Error Halt
Disk Wirestripper Bands (TCOL)	512 1376 2576 4316	Not pertinent Not pertinent Not pertinent Not pertinent	Memory error halt Memory error halt Programmer use halt Disk error halt
Disk Wirestripper No-Bands (TCOL)	612 1163 4321	Not pertinent Not pertinent Not pertinent	Memory error halt Memory error halt Disk error halt
Dectape Bands (TCOL)	0611 5171		Illegal Character DEctape Error Halt
DEC-tape No-Bands (TCOL)	0611 5171	Status B Reg.	Illegal Character DEctape Error Halt
DEctape Wirestripper Bands (TCOL)	612 1376 2576 4573	Not pertinent Not pertinent Not pertinent Stat. Reg.B.	Memory error halt Memory error halt Programmer use halt DEctape error halt
DEctape Wirestripper NO-Bands (TCOL)	612 1163 4572	Not pertinent Not pertinent Stat. Reg.B.	Memory error halt Memory error halt DEctape error halt

COLD TYPE PROGRAMS

Fototronic 12ØØ & TXT Disk System (TCOL)	537 3ØØ5 3517	Stat Reg. B. Not pertinent Not pertinent	Dectape error halt Disk error halt Memory Error halt
--	-------------------------	--	--

PAGE 829

PAGE REVISION A

PUBLICATION DATE May 1973

COMPANY CONFIDENTIAL

Title		ERROR HALTS IN DEC TYPESETTING SOFTWARE (Cont')			Tech Tip		TYPESET	
					Number		SFTWRE-TT-14	
All	Processor Applicability			Author	R. Hartz	Rev	A	
	8			Approval	G. Chaisson	Date	5/23 /73	
Cross Reference								

COLD TYPE PROGRAMS (Continued)

PROGRAM TITLE	LOCATION	AC CONTENTS	REASON
Fototronic 12 00 & TXT (TC01) Non-Disc	537	Stat. Reg. B	DECTape error halt
	3512	Not pertinent	Memory error halt
713 Display Ad (TC01) Disk System	54 0	Stat. Reg. B	DECTape error halt
	3 00 4	Not pertinent	Disk error halt
	44 0 6	Not pertinent	Programmer use halt
	4416	Not pertinent	Programmer use halt
713 Display Ad Non- Disk TC01	54 0	Stat. Reg. B	DECTape error halt
	44 0 7	Not pertinent	Programmer use halt
	4417	Not pertinent	Programmer use halt
Linofilm (TC01) Disk	544	Stat. Reg. B	DECTape error halt
	726	Not pertinent	Programmer use halt
	3 00 4	Not pertinent	Disk error halt
	3575	Not pertinent	Memory error halt
Linofilm Non-Disk	544	Stat. Reg. B	DECTape error halt
	726	Not pertinent	Programmer use halt
	3 0 45	Not pertinent	Memory error halt
560 (TC01) Disk	555	Stat. Reg. B	DECTape error halt
	3 00 4	Not pertinent	Disk error halt
	3 0 64	Not pertinent	Memory error halt
	4364	Not pertinent	Programmer use halt
	4415	Not pertinent	Programmer use halt
560 TC01 Non-Disk	555	Stat. Reg. B	DECTape error halt
	3 00 6	Not pertinent	Memory error halt
	4364	Not pertinent	Programmer use halt
	4415	Not pertinent	Programmer use halt
513 (TC01) Disk	555	Stat. Reg. B	DECTape error halt
	3 00 4	Not pertinent	Disk error halt
	3 0 56	Not pertinent	Memory error halt
	4407	Not pertinent	Programmer use halt
	4417	Not pertinent	Programmer use halt
513 (TC01) Non-Disk	555	Stat. Reg. B	DECTape error halt
	3 00 6	Not pertinent	Memory error halt
	44 0 7	Not pertinent	Programmer use halt
	4417	Not pertinent	Programmer use halt

COMPANY CONFIDENTIAL

digital	FIELD SERVICE TECHNICAL MANUAL				Option or Designator
	12 Bit <input checked="" type="checkbox"/>	16 Bit <input type="checkbox"/>	18 Bit <input type="checkbox"/>	36 Bit <input type="checkbox"/>	TYPESET SOFTWARE

Title ERROR HALTS IN DEC TYPESETTING SOFTWARE				Tech Tip TYPESET Number SFTWRE-TT-14	
All	Processor Applicability			Author R. Hartz	Rev A
	8			Approval G. Chaisson	Date 5/23/73
					Cross Reference

COLD TYPE PROGRAMS (continued)

<u>PROGRAM TITLE</u>	<u>LOCATION</u>	<u>AC CONTENTS</u>	<u>REASON</u>
Classified Ad II Storage	1Ø43 Ø351	Disc status Not pertinent	Disc error halt Illegal TTY command in class ad storage mode
Compugraphic 9ØØØ	3ØØ4 Ø536	Disc status Status B req.	Disc error halt DEC tape error

Class Ad III version
No.3 (713 display
used)

Display Exec. Prog. Field Ø	741Ø		DEctape bootstrap error
Ø	7422		Core patch halt SW= ØØØØ
Ø	Ø232		Disk error at start
Ø	2113		Disk illegal sub. sector
Ø	2535		DEctape error (AC= status B)
Ø	1737		Disk transfer error
Ø	3627		Disk full error

Class Executive Program Field Ø	741Ø		DEctape bootstrap error
Ø	7422		Core patch halt SW=0000
Ø	Ø232		Disk error at start
Ø	2135		Disk illegal sub- sector
Ø	254Ø		DEctape error (AC= status B)
Ø	1741		Disk transfer error

COMPANY CONFIDENTIAL

Title ERROR HALTS IN DEC TYPES						Tech Tip TYPESET Number SPTWRE-TT-14		
All	Processor Applicability					Author R. Hartz	Rev A	Cross Reference
	8					Approval G. Chaisson	Date 5/23/73	

COLD TYPE PROGRAMS (continued)

<u>PROGRAM TITLE</u>	<u>LOCATION</u>	<u>AC CONTENTS</u>	<u>REASON</u>
Updating Program Field 1	1221		Disk header area full
" 1	21#		Disk failure on read
Initializing Program Field 1	#312		Disk compare error
1	#254		Disk failure on write
Translating Program Field 1	#216		Ad found in class #
1	#27#		Disk full error
1	#634		bad ad on dectape
Kill program Field 1	#345		Disk failure on read
List Program Field 1	#213		Disk failure on read
Edit Program Field 1	210		Disk failure
1	537		Disk full error
Sort program Field 1	255		Disk failure
1	307		Disk full error
Run Count Update Field 1	332		Disk failure
Skip Key Update Field 1	210		Disk failure
Dump Program Field 1	243		Disk failure
Proof program Field 1	210		Disk failure
Size command Field 1	243		Disk failure

COMPANY CONFIDENTIAL

DIGITAL EQUIPMENT CORPORATION

digital	FIELD SERVICE TECHNICAL MANUAL				Option or Designator
	12 Bit <input checked="" type="checkbox"/>	16 Bit <input type="checkbox"/>	18 Bit <input type="checkbox"/>	36 Bit <input type="checkbox"/>	TYPESET SOFTWARE

Title					ERROR HALTS IN DEC TYPESETTING SOFTWARE (Cont'd)		Tech Tip TYPESET Number SFTWRE-TT-14
All	Processor Applicability				Author R. Hartz	Rev A	Cross Reference
	8				Approval G. Chaisson	Date 5/23 /73	

AUXILIARY PROGRAMS

<u>PROGRAM TITLE</u>	<u>LOCATION</u>	<u>AC CONTENTS</u>	<u>REASON</u>
Disk Termination (TC01)	6311 6365	Stat. Reg. B Not pertinent	DEctape error halt Disk error halt
Disk System Loader (TC01)	6112 5546 7444 7554	Stat. Reg. B Not pertinent Stat. Reg. B Not pertinent	DEctape error halt Disk error halt DEctape error halt Disk error halt
TC01 - Disk Patcher	674	Stat. Reg. B Not pertinent	DEctape error halt Disk error halt
TC01 - Disk Diction- ary Editor	1252 1534	Zero Stat. Reg. B Not pertinent	Insertion error DEctape error halt Disk error halt
TC01-Disk Zero Production Stats	44	Not pertinent	Disk error halt
TRMBLK (TC01- Non-Disk)	6322	Stat. Reg. B	DEctape error halt
SYSLOD (TC01- Non-Disk)	7443	Stat. Reg. B	DEctape error halt
PATCHB (TC01- Non-Disk)	674	Stat. Reg. B	DEctape error halt
EDTSYS (TC01- Non-Disk)	1523	Stat. Reg. B	DEctape error halt
ZSTATS (TC01- Non-Disk)	250	Stat. Reg. B	DEctape error halt
UPDATE (TC01- Non-Disk)	327	Not pertinent	Operation done halt
COPSYS (TC01- Non-Disk)	212 303 314	Not pertinent Not pertinent Stat. Reg. B	Programmer use halt Comparison error halt DEctape error halt
PSTATS (TC01- Non-Disk)	323	Stat. Reg. B	DEctape error halt

COMPANY CONFIDENTIAL

Title ERROR HALTS IN DEC TYPESETTING SOFTWARE (Cont)					Tech Tip TYPESET Number SFTWRE-TT-14	
All	Processor Applicability				Author R. Hartz	Rev 0
	8				Approval G. Chaisson	Date 02/02/73
						Cross Reference

AUXILIARY PROGRAMS (Continued)

PROGRAM TITLE	LOCATION	AC CONTENTS	REASON
DSKTRM (552 Disk)	6314	Stat. Reg. B	DEctape error halt
	6367	Not pertinent	Disk error halt
TRMBLK (552 Non-Disk)	6325	Stat. Reg. B	DEctape error halt
DSKLOD (552 Disk)	7450	Stat. Reg. B	DEctape error halt
	7544	Not pertinent	Disk error halt
	5546	Not pertinent	Disk error halt
	6123	Not pertinent	DEctape error halt
SYSLOD (552 Non-Disk)	7447	Stat. Reg. B	DEctape error halt
PATCHB (552 Disk)	734	Stat. Reg. B	DEctape error halt
	755	Unit Number	DEctape error halt
PATCHB (5 2 Non-Disk)	734	Stat. Reg. B	DEctape error halt
	755	Unit number	DEctape block error
EDTSYS (552 Disk)	1252	Not pertinent	Storage error halt
	1724	Stat. Reg. B	DEctape error halt
EDTSYS (552 Non-Disk)	1252	Not pertinent	Storage error halt
	1724	Stat. Reg. B	DEctape error halt
ZTATS (552 Disk)	44	Not pertinent	Disk error halt
ZSTATS (552 Non-Disk)	254	Stat. Reg. B	DEctape error halt
UPDATE (552 Disk)	327	Not pertinent	Operation done halt
	353	Address of err.	Various errors
	742	Unit Number	DEctape block error
UPDATE (552 Non-Disk)	204	Not pertinent	Programmer use halt
	327	Not pertinent	Operation done halt
	353	Addr. of error	Various errors
	741	Unit number	DEctape block error
COPSYS (552 Disk)	212	Not pertinent	Programmer use halt
	345	Not pertinent	Comparison error
	356	Stat. Reg. B	DEctape error halt

COMPANY CONFIDENTIAL

digital	FIELD SERVICE TECHNICAL MANUAL				Option or Designator
	12 Bit <input checked="" type="checkbox"/>	16 Bit <input type="checkbox"/>	18 Bit <input type="checkbox"/>	36 Bit <input type="checkbox"/>	TYPESET SOFTWARE

Title ERROR HALTS IN DEC TYPESETTING SOFTWARE (Contin'd)				Tech Tip Number	TYPESET Software-TT-14
All	Processor Applicability			Author	R. Hartz
	8			Approval	G. Chaisson
				Rev	0
				Date	02/02/73
				Cross Reference	

PROGRAM TITLE	LOCATION	AC CONTENTS	REASON
PSTATS (552 Disk)	233	Not pertinent	Disk error halt
STOCK EDITOR	770 2172	Addr. of err. Stat. Reg. B	Various errors DEctape errors halt

Title PHOTON PACESETTER INPUT TAPES				Tech Tip Number	TYPSET SFTWRE-TT-15
All	Processor Applicability			Author	J. Gleeson
	8's	11		Approval	G. Chaisson
				Rev	0
				Date	02/02/73
				Cross Reference	

I. Introduction

The purpose of this Tech Tip is to enable the user to read computer output tapes accepted by the Pacesetter series of Photo composition machines. An understanding of the code structure is helpful when trying to differentiate between bad output due to Pacesetter malfunction or bad output due to the Typeset 8/11 system malfunction.

2. Tape Format

The Pacesetter uses the TTS code structure. Commands consist of a bell code followed by an alpha-numeric character and up to four (4) digits containing the parameters of the command.

Not all of the Pacesetter functions will be listed in the table since they are not all necessary in computer-mode.

COMPANY CONFIDENTIAL

Title						Tech Tip	
PHOTON PACESETTER INPUT TAPES (Continued)						TYPSET	
						Number	
						SFTWRE-TT-15	
Processor Applicability			Author		Rev		Cross Reference
All			J. Gleeson		0		
8's			Approval		Date		
11			G. Chaisson		02/02/73		

3. Function Codes (* = Bell Code)

<u>Function</u>	<u>Flag Code</u>	<u>Followed By</u>
Type Face	*t	1 digit for Typeface 1-8
Line Length	*l	4 digit; 2 for picas, 2 for points
Point Size	*p	2 digit; for sizes 05-72
Leading	*v	3 digits; $\frac{1}{2}$ pts of lead 0-255
Add Lead	*a	3 digits; $\frac{1}{2}$ pts of lead 0-255
No Flash (next character)	*b	-
Cancel Flash (Until EOL or "Allow Flash")	*.	-
Allow Flash	*u	-
Zero Width (Next Character)	*ø	Desired Character
Supercase Characters	*y	Desired Character
Quad Right	*q	-
One Unit Space	*l	-
Kern ($\frac{1}{2}$ unit for each code)	*m	-
Stop	*T.F.	-

4. Spacing

In addition to the EM, EN and THIN and ONE UNIT space noted above, there are four (4) other sizes of fixed spacing used.

- a) $\frac{1}{2}$ unit space called by *5
- b) three (3) larger spaces (undefined at this stage) called by *7 *8 *9.

5. Quadded/Justified Lines

All justified lines and Quad Right Lines will be ended with a Quad Left and Return (33,20). Spacing necessary to justify the line will be included in the line. Quad Left and Quad Center Lines will end the same but will not output the spacing on the right hand side.

COMPANY CONFIDENTIAL

DIGITAL EQUIPMENT CORPORATION

digital	FIELD SERVICE TECHNICAL MANUAL				Option or Designator TYPESET SOFTWARE
	12 Bit <input checked="" type="checkbox"/>	16 Bit <input type="checkbox"/>	18 Bit <input type="checkbox"/>	36 Bit <input type="checkbox"/>	

Title PHOTON FACESETTER INPUT TAPES (Continued)				Tech Tip Number		TYPESET SFTWRE-TT-15	
Processor Applicability		Author J. Gleeson		Rev 0		Cross Reference	
All 8's	ll	Approval G. Chaisson		Date 02/02/73			

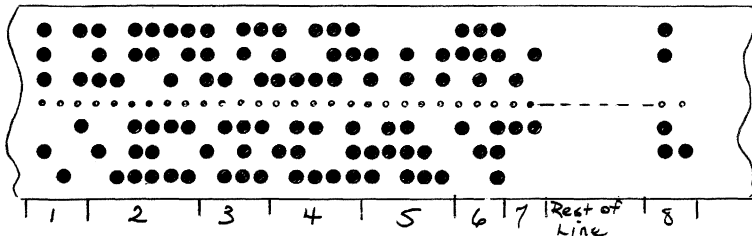
6. Example

- a. Type Face #8 *t8
- b. Line Length 11.6 pica *1 1106
- c. Point Size 10 points *p10
- d. Leading 10½ points *v021
- e. Shift N - Unshift o w
- f. Interword Spacing-EM plus One unit
- g. is
- h. Quad Left, Return

COMPANY CONFIDENTIAL

-- NOTES --

digital	FIELD SERVICE TECHNICAL MANUAL				Option or Designator
	12 Bit <input checked="" type="checkbox"/>	16 Bit <input type="checkbox"/>	18 Bit <input type="checkbox"/>	36 Bit <input type="checkbox"/>	TYPESSET - 8
Title				Tech Tip	
TELETYPE BYPASS PROCEDURE				SOFTWARE	
Processor Applicability				Number TYPSET-8-TT-16	
All	Author Fred Miller		Rev 0		Cross Reference
x	Approval <i>Fred Miller</i>		Date May 2, 73		

The following example is page A1 from the Typeset-8 Users Guide. Under program designator A and D you will see numbers written in the provided space. They are the starting addresses of the Auto Loader Program and the Disk Refresh Program for all the Dis/Dectape Typeset Systems and the Dectape only Typeset Systems.

They are provided for the customer to use in the event of teletype failure.

To use follow this procedure for Disk Dectape Systems.

1. Start the typeset bootstrap Loader at 7730 and wait for the Dectape on unit 4 to stop moving.
2. Press stop and load the appropriate address for disk refresh. Press start.
3. Wait for the Dectape to stop, press stop, then load the address for the auto loader, press start.
4. The system should now be searching the typeset readers for input tapes. The customer could continue to run this way until teletype can be repaired.

For the Dectape only System:

Eliminate Step #2.

COMPANY CONFIDENTIAL

Title TELETYPE BYPASS PROCEDURE						Tech Tip Number TYPSET-8-TT-16			
All X		Processor Applicability				Author Fred Miller		Rev g	Cross Reference
						Approval		Date 5/2/73	

Appendix A Program Complement

A list of composition programs, auxiliary programs and utility programs is prepared for each Expanded Typeset-8 System, Expanded Disk Typeset-8 System, and Disk Typeset-8 System. The information includes the program title and corresponding program designators. Program designators are subject to change, depending on system requirements.

Substitute the applicable program complement for this appendix when preparing the system software package. The program complement is supplied by the Typeset-8 Programming Group. A master program complement containing all currently used program designators is presented in Table A-1.

Table A-1
Master Program Complement

Program Designator	Program Title	Program Designator	Program Title
A	Automatic Loader for Composition Programs (DECtape starting address <u>7513</u> , DECdisk starting address <u>7514</u>)	N **	Hot Metal NO Bands Composition
B *	Block Copier	O ***	Allotting Editor
C **	Cold Type Photocomposition Display Ad	P	Production Statistics Printout
D	Disk Refresh (Starting Address <u>5400</u>)	Q	Not assigned.
E	Exception Word Dictionary Editor	R *	Reload Standard DEC Loaders
F	Format Block Generator for Photon 713 Text Composition Program	S **	Stock Editor
G	Not assigned.	T	Tape Copier
H **	Hot Metal Bands Composition	U	System Update
I	Ad Storage	V	Not Assigned
J	Merge Justified Tapes	W	Wire Storage
K	Format Editor	X *	System Patcher
L	Hyphenation Logic Test	Y	Fordax Loaders
M	Memory Tape Generator for 713 Display Composition	Z	Zero Production Statistics
		4 **	Compugraphic 4962 Text Composition
		5 **	Extra Photon Composition
		7 **	Photon 713 Text Composition

* Utility program reserved for use by authorized DEC personnel only. Do not include them in program complement.

** Accepted by Auto-Loader Program

*** These programs have not been released. Do not include them in program complement until notified by Typesetting Program Department.

digital	FIELD SERVICE TECHNICAL MANUAL				Option or Designator
	12 Bit <input checked="" type="checkbox"/>	16 Bit <input checked="" type="checkbox"/>	18 Bit <input checked="" type="checkbox"/>	36 Bit <input checked="" type="checkbox"/>	UART

Title					Tech Tip	
ADDITION OF PARITY TO UART					Number UART-TT-1	
All	Processor Applicability			Author	J. Blundell	Rev
X				Approval	F. Purcell	Date
						0
						10.12.72
				Cross Reference		

The addition of parity to the UART (Universal Asynchronous Receiver Transmitter) I.C. is relatively easy, i.e. Pin 35 when low enables parity, when high disables parity. The normal format of data used in asynchronous communications is START BIT (1) - DATA BITS (5-8) - STOP BITS (1-2). An example would be 1 START BIT - 8 DATA BITS - 2 STOP BITS or a total of 11 bits. When enabling parity in the UART, the parity bit is added after the last data bit on transmission and expected after the last data bit on receive. Thus if you enable parity and have a character length of 8 bits selected (see table below) the normal 11 bit character is extended to 12 bits, i.e., 1 START, 8 DATA, 1 Parity, 2 STOP. The solution to this is when parity is enabled make the data bits equal to one less than if parity is disabled.

The data bit may be adjusted as shown below:

<u>Pin 37</u>	<u>Pin 38</u>	<u>Data Bits</u>
LOW	LOW	Five
LOW	HIGH	Six
HIGH	LOW	Seven
HIGH	HIGH	Eight

COMPANY CONFIDENTIAL

NOTES

digital	FIELD SERVICE TECHNICAL MANUAL				Option or Designator
	12 Bit <input checked="" type="checkbox"/>	16 Bit <input checked="" type="checkbox"/>	18 Bit <input checked="" type="checkbox"/>	36 Bit <input type="checkbox"/>	UDC

Title UDC 11 DIAGNOSTIC				Tech Tip Number UDC-TT-1	
All Processor Applicability		Author L. Goelz	Rev A	Cross Reference	
11		Approval G. Chaisson	Date 10/20/72		

In order to ensure proper checkout of W734 counter modules in an UDC System, the UDC System Function Exerciser should be labeled MAINDEC-11-DZUDA-A. The UDC Exerciser that is labeled MAINDEC-11-D8JA will not support the counter module properly. The probable symptom that occurs is the counter module operates properly in address $\beta\beta\beta$ but when put in another address slot, it will not run all the tests. This new revision tape is available in the Program Library.

Title W734 UDC COUNTER MODULE				Tech Tip Number UDC-TT-2	
All Processor Applicability		Author A. Thompson	Rev 0	Cross Reference	
8	11 15	Approval G. Chaisson	Date 07/06/72		

In a UDC System containing both contact interrupt modules (W732,W733) and W734 counter modules or multiple W734 counter modules, the following problem exists:

If the signal "RIF" is generated, all counter modules will have their interrupt flags cleared. This condition is undesirable due to this causing loss of interrupt information. The correct operation is that only the module addressed by the UDC controller should respond to the "RIF" signal.

Correction: ECO #W734-0001A has been generated to alleviate this problem.

COMPANY CONFIDENTIAL

CPL

Title UDC-8, 11, 15 Signal Conditioning						Tech Tip Number UDC-TT-3		
All	Processor Applicability					Author G. Chaisson	Rev 0	Cross Reference
	8	11	15			Approval W. Cummins	Date 7-31-72	

PROBLEM: Several recent complaints of intermittent operation and damage to modules (burned components and destroyed etch) have been reviewed and corrected.

SOLUTION: The relay output modules (M802, M803, M804, M805, M806, and M807) must have Arc Suppression networks installed on the W400, W402, or W403 before the UDC is connected to any customer equipment.

SYMPTOMS: Without the Arc Suppression networks, the opening and closing of the relay contacts cause large inductive voltages. These high voltages can and do arc across the etch lands either causing intermittent problems or burning the etch of the board.

CPL

Title UDC 8, 11, 15 - G729 ADDRESS SELECTOR						Tech Tip Number UDC-TT- 4		
All	Processor Applicability					Author G. Chaisson	Rev 0	Cross Reference
	8	11	15			Approval W. Cummins	Date 7-31-72	

PROBLEM: Attempts to select an I/O module address are unsuccessful in some cases. Selection problems appear in groups of 4 I/O module addresses or more and all I/O modules are accessed at once.

SOLUTION: The G729 X, Y, jumper card split lugs require resoldering to make proper connection. When either X or Y is not applied to the address decoding the input to these gates float causing improper selection.

COMPANY CONFIDENTIAL

digital	FIELD SERVICE TECHNICAL MANUAL				Option or Designator
	12 Bit <input type="checkbox"/>	16 Bit <input checked="" type="checkbox"/>	18 Bit <input checked="" type="checkbox"/>	36 Bit <input type="checkbox"/>	UDC 300-111

Title UDC TESTER SETTINGS FOR W402 SIGNAL CONDITIONER			Tech Tip Number	UDC-TT-5
All	Processor Applicability		Author Noel Smith	Rev 0
	8's	11's	15's	Cross Reference
Approval J. Blundell			Date	May 2, 1973

Because of the way in which the UDC tester connects to the W402 signal conditioning module, one of the voltage scaling resistors is not included in the circuit, resulting in a tester voltage setting that is different from the customers field power source.

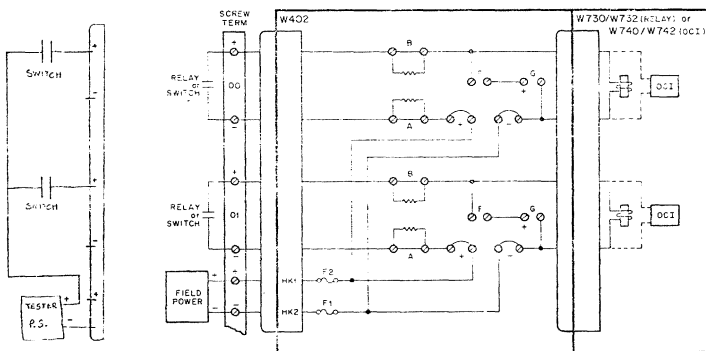

Tester Field

You will see that resistor A is not in circuit when using the tester, which results in the following jumper/voltage relationship.

Customer Power Source	Voltage Scaling Jumpers	UDC Tester Switch	Setting
6V	Both jumpers in		6V
24V	Cut jumper A		6V
48V	Cut jumpers A and B		24V

Title						Tech Tip	
UDC TESTER SETTINGS FOR W402 SIGNAL CONDITIONER						Number	
Processor Applicability						UDC-TT-5	
All		Author		Noel Smith		Rev 0	
8	11	15	Approval		J. Blundell		Date
							May 5, 1973
						Cross Reference	

One other source of confusion around the W402 and other signal conditioning cards is the method of naming the contacts at the field input end of the card. Viewed from the handle end, board vertical, components on your right (as it would be when in the system), the pins are lettered "A" through "V" starting at the top. This means that side 1 of the board (component side) will connect to side 2 of the cable connector (marked A thru V, top to bottom).

Title						Tech Tip	
SKIP INTERRUPT TIMING						Number	
Processor Applicability						UDC-TT-6	
All		Author		L. Goelz		Rev 0	
8			Approval		C. Chaisson		Date
							8/7/73
						Cross Reference	

There is a time when the possibility of losing an interrupt exists in the skip circuit. This loss occurs when waiting for an interrupt, by doing a skip then JMP-1. A typical section of a routing where this possibility exists is:

UDSF (skip on UDC flag)
JMP-1 (JMP back one)

If the interrupt is handled by setting ION, then this problem does not occur.

The reason for this error is as follows: After the interrupt sets the interrupt flag in the UDC, it is gated with the skip IOT out to the skip bus and also it clears the interrupt flag and the interrupt enable flip-flop. The problem comes about when the interrupt occurs near the end of the skip IOT. When it is gated with the IOT, the resulting pulse is too short in duration to drive the skip line LOW but is enough to clear the interrupt flag and interrupt enable flip-flop, thereby causing the loss of the interrupt.

An ECO is in process to correct this problem and will be available in August 1973 for UDC 8's.

COMPANY CONFIDENTIAL

digital	FIELD SERVICE TECHNICAL MANUAL				CPL Option or Designator
	12 Bit <input type="checkbox"/>	16 Bit <input type="checkbox"/>	18 Bit <input type="checkbox"/>	36 Bit <input type="checkbox"/>	UDC

Title					Contact Sense and Interrupt Interaction		Tech Tip Number		UDC-TT-7			
All					Processor Applicability		Author		Rev #		Cross Reference	
					8 11 15		G. Chaisson		#			
							Approval		Date			
							G. Chaisson		8/7/73			

Problem: W730 and W731 Contact Sense modules can exhibit interaction between modules, i.e., two or more adjacent W730's or W731's. The symptom appears as an inability to cause a bit to set, or possibly the setting of a bit when another adjacent bit is set.

Cause: The problem is caused from magnetic interference between relay packages on adjacent modules. The relays that are used are form B's, normally closed (held closed by a small internal permanent magnetic). When all the contacts in a relay package are opened (getting those bits) a strong enough influence is asserted on the relay package on an adjacent module to cause the interaction.

Solution: An ECO is being written to provide a 1 square inch magnetic shield that will be fitted to the top of each relay package. (ECO W730-00002, ECO W731-00001).

It must be emphasized that not any metal will work as an adequate magnetic shield. Only the material supplied in the ECO kit should be used since it is a specific density and thickness.

Title					USING BW406 MODULE		Tech Tip Number		TT# 8			
All					Processor Applicability		Author		Rev #		Cross Reference	
					8 11 15		L. Goetz		#			
							Approval		Date			
							G. Chaisson		2/1/74		BW406 TT#1	

Reference purposes only.

Title						Tech Tip	
DD#1-D Cross Talk						Number	
Processor Applicability						UDC-TT-9	
All		Author P. Dudziak		Rev 0		Cross Reference	
11		Approval D. Herbener		Date 3/13/74			

Cross-Talk

Problems are appearing when multiple interrupt modules are placed in a DD#1-D.

The problem is caused by the routing of all data and control signal lines in one common wire bundle.

The symptoms of the problem appear as a module failing to interrupt when a change of state occurs for any particular bit.

The solution to the problem is the re-routing of four control lines per FCO #DD#1D-C0007. The wires which must be re-routed are LOAD, START ADRX and ADRY. Wires should be re-routed as indicated below.

From	To
Load B12H1	E11H2
Start B12F1	F11D2
ADRX B12A1	E11D2
ADRY B12B1	E11E2

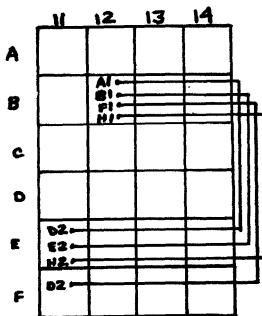

	FIELD SERVICE TECHNICAL MANUAL				Option or Designator
	12 Bit <input type="checkbox"/>	16 Bit <input checked="" type="checkbox"/>	18 Bit <input type="checkbox"/>	36 Bit <input type="checkbox"/>	UDC

Title UDC POWER PROBLEM				Tech Tip Number UDC-TT-10		
All	Processor Applicability			Author P. Dudziak	Rev 0	Cross Reference
	8	11		Approval D. Herbener	Date 3/13/74	

Due to the increased power consumption brought about by such modules as the AD#1, problems have begun to appear. In some cases the symptoms may indicate that a particular module is at fault when the problem is really one of power distribution e.g. an ADU#1 due to its high current load may cause a BA633 to fail. A temporary fix for these symptoms is to raise the output of the H740-D. The UDC Maintenance Manual currently calls for the H740-D to be adjusted to 5 volts based on measurements taken at the rear of AG729 card. The proper reference point to use for 5 volt adjustments is on the DD01-D back plane at pins C14A2 (+5) and C14C2 (ground) for the master file power supply and DD02 pins A4A2 (+5) and A4C2 (ground) for additional supplies. Care must be taken when making this adjustment as the H740-D might crowbar and blow a fuse. The permanent solution to this problem is the re-distribution of power per the proper FCO referenced below.

CAUTION

Once the H740-D is adjusted under full load, no module should be removed with power applied to the UDC files. When the system is powered down and a module is removed, it must be replaced with one of equal load. Failure to comply with the above procedure may cause the power supply to crowbar and blow a fuse.

In order to eliminate the possibility of power supply overloading and failure, the following guidelines must be adhered to when configuring, re-configuring or adding-on to AUCD system.

1. The Master File has 16 AMPS (MAX.) available for I/O modules. This may be extended to 36 AMPS (MAX.) by the installation of an additional H740-D p/s.
2. The expander files have 18 AMPS (MAX.) available for I/O modules. This may be extended to 38 AMPS (MAX.) by the installation of an additional H740-D p/s.
3. The following table may be used to determine module loads.

Title UDC POWER PROBLEM (CONT'D)						Tech Tip Number UDC-TT-10	
Processor Applicability				Author P. Dudziak		Rev 0	
All		8 11		Approval D. Herbener		Date 3/13/74	
				Cross Reference			

UDC8		UDC11	
Item	Consumption (AMPS)	Item	Consumption (AMPS)
DD01	3.5	DD01	3.5
DD02	0.3	DD02	0.3
W740	0.35	ADU01	1.8
W742	0.45	M681	0.8
M684	0.5	W410	0.24
M686	0.8	W741	0.3
M802	0.5	W743	0.45
M804	0.45	M685	0.7
M806	0.8	M687	1.0
M681	0.8	M803	0.7
W410	0.24	M805	0.7
W734	1.0	M807	1.0
W402	NONE	W734	1.0
W403	NONE	W402	NONE
W406	NONE	W403	NONE
ADU01	1.8	W406	NONE
A633	power is	A633	power is
A233	supplied by	A233	supplied by
A234	one H738A	A234	one H738A
A235	per (4) A633	A235	per (4) A633
A236	modules	A236	Modules

If power problems occur during an add-on installation or re-configuration the power wiring from the H740-D(S) should be updated via FCO. The appropriate FCO numbers are noted below:

FCO NO. IDAC -C0004
DD01-D-C0007
DD02-C0005

digital	FIELD SERVICE TECHNICAL MANUAL				Option or Designator
	12 Bit <input checked="" type="checkbox"/>	16 Bit <input type="checkbox"/>	18 Bit <input type="checkbox"/>	36 Bit <input type="checkbox"/>	VC12

Title				LONG EXTENDED SCOPE CABLE PROBLEMS		Tech Tip Number		VC12-TT-1	
All	Processor Applicability			Author		Rev		Cross Reference	
	12			Approval H. Long		Date 08/17/72			

A large number of ECO's have been written to provide the VC12 scope control with the ability to drive extended scopes with cables longer than 25 feet. Below is a synopsis of those ECO's with additional comments.

1. EML2-00023 - January 1970 (All Systems)
Adds a 100 ohm resistor in series with pin A1 of the G783 cable connector in slot F39.
2. EML2-C0033 - March 1970 (All Systems)
Specifies that ECO M711-C0002 applies to all systems.
3. M711-C0004 - August 1970 (All Systems)
CS and Etch Revision to drive long cable new module Rev. "C".
4. EML2-00039 - August 1970
Implements side 2 wiring for special long cable. Wiring errors corrected by EML2-00046. Errors in EML2-00046 corrected by EML2-00049 speco kit not available.
5. EML2-B0046 - March 1971 (All Systems)
Corrects EML2-00039
Wiring error corrected by EML2-00048.
6. EML2-B0048 - May 1971 (All Systems)
Corrects EML2-00046 Speco kit for EML2-00039 is included in ECO.
7. EML2-C0049 - May 1971 (All Systems)
Orders installation of EML2-00039, 00046, and 00048; M711-00004, A615-00004, and two new side 2 (W020) cable assemblies.
8. A615-00004 - March 1971 (All Systems)
CS and ETCH Rev to provide additional stability. New module Rev. E
9. BC12A-00002 - August 1970 (All Systems)
Provides common ground drain by tying all drains together at the scope end of the cable. New cable Rev. "C".

COMPANY CONFIDENTIAL

Title CRT ARCING					Tech Tip Number VC12-TT-2		
All	Processor Applicability				Author	Rev	Cross Reference
	12				Approval H. Long	Date 08/17/72	

The spacing between electrodes in the gun of a CRT is small and can be, because the gun operates in a vacuum and thus break down or arcing distances for a give high voltage is much smaller than in air. Most CRTs are coated inside with a material called aquadag, which is a conductive paint that contains a heavy concentration of carbon particles. In high volume production of CRTs, some units may have a few carbon particles "floating" around inside the tube. If these particles become lodged between electrodes that have high voltage, an arc will occur. The arc usually burns out the contaminating particle, however, not without first connecting the electrode in question to 12 or 15KV. The most frequent electrodes subject to arcing are the cathode and second grid. Low voltage circuitry and transistors usually drive these electrodes and thus are subject to absorbing momentarily the high voltage that strikes them. Sometimes the high voltage arc does not damage these circuits, but instead destroy other components in other circuits such as power supplies or deflection amplifiers. Integrated circuits seem especially susceptible to arcing CRTs.

Whenever trouble shooting equipment such as VR14, VR20, VT05, VT06, VT04 and the failure appears to be "random" such as several unrelated circuits blowing (i.e. an intensity failure with a power supply problem) suspect an arc. Some CRTs will arc once or twice in their life- others will arc regularly. Fortunately, frequent arcing CRTs are a rarity, but none the less do exist. If CRT equipment is serviced two or three times with apparently "random" IC or transistor failures, the CRT might be the source of the problem and should be replaced. Differentiating between arcing problems and other circuit malfunctions is difficult, but with all the CRT equipment DEC has in the field I cannot help but feel some units with frequent field service calls, have this problem from time to time and go undetected.

Again always double check circuits for proper operation if an arc is suspected. Sometimes partial damage to transistors and op amps (such as MC1709) can occur which may appear to be working but are partially shorted or leaky.

COMPANY CONFIDENTIAL

digital	FIELD SERVICE TECHNICAL MANUAL				Option or Designator
	12 Bit <input checked="" type="checkbox"/>	16 Bit <input type="checkbox"/>	18 Bit <input type="checkbox"/>	36 Bit <input type="checkbox"/>	VC8E

Title				Tech Tip VC8E TT#1		
VC8E-Lab 8E - USE AND MODIFICATION				Number		
All	Processor Applicability			Author	Rev	Cross Reference
	8E			A. Wallack/ G. Chaisson	0	
			Approval	W. Cummins	Date	7-31-72

On many occasions customers do not purchase a scope from DEC to go with their VC8E. The following information is an attempt to aid in getting the customers system up and running. (Note: modifications to standard DEC modules to accommodate a customers scope are no longer DEC's responsibility.)

The VC8E display controller was designed to accommodate the VR14, Tektronix 602 and the RM503 scopes. However, with certain modifications the VC8E can interface to many other scope and plotters as well. The following guidelines must be taken into consideration before attempting to control a scope that has not been specified by DEC.

A. Intensification Pulse

1. Pulse width - the VC8E can supply a 1 usec pulse width. However, to avoid reflection on long cables, a 200 nsec rise time (fall time if negative) is incorporated into the pulse width. Therefore, the width is defined from the start of the pulse to the completion.

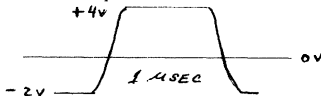

Many scopes other than the ones mentioned above require longer pulse widths. As an example, some storage scopes require approximately a 5 to 6 usec pulse width. The VC8E cannot accommodate such scopes unless the user changes the 1 usec pulse generator (on M869) to a larger value. This would require changing the capacitor (M869 C23) to another value which is appropriate to the user's application. All scope manuals should define pulse width. (Calculation of the new value of C23 should be done using the Fairchild 9601 IC spec sheet.)

2. Polarity - The VC8E contain provisions to change the polarity of the output signal by a switch on the M869 module. Improper value of the intensify polarity will result in signal blanking at the wrong times. (Retraces may be seen).

COMPANY CONFIDENTIAL

3. Voltage - the VC8E can generate pulse voltages from +4V to -2V. It can also, with the removal and addition of certain jumpers (W1 & W2) on the M885 module, generate a +4V to -10V voltage swing. However, one should note that the rise and fall times will be greater. In many cases, the intensify pulse input requirements to various scopes are 0 to 1V. An external adjustment on the scope or a special attenuating network would have to be used. This is the user's responsibility and must be considered before attempting to interface. As in the case of the Tektronix 602, DEC sells a VM03 kit which includes mounting hardware, and attenuating resistors and capacitors. The Tektronix 602 has provisions in its circuitry for the addition of external components. However, this may not be true of other scopes.

X and Y Outputs

1. Voltage - the voltages generated by the X and Y outputs of the VC8E are + and -5 volts. "This cannot be modified." The user must have external attenuators or an internal scope gain adjustment. One must also note that many scopes call for only positive voltage swings. However, usually an offset position can be adjusted to correct input polarity problems. (This adjustment must be internal to the scope.)
2. Settling time (control) - the VC8E is a scope control and not a D/A converter. The settling time from maximum deflection full scale step is 4 usec. Many scopes have faster settling times than 4 usec. The user in this case should use the internal delay set by the option at its minimum value (6 usec).
3. Settling time (scope) - scope settling times may vary from 1 usec to 50 usec. The VC8E was designed for the VR14 and Tektronix 602 (with VM03 option) as stated previously. A done flag will occur when either scope has reached its settling time, internally timed on the VC8E (20 usec for the VR14 and 6 usec for Tektronix 602). However, all scopes differ somewhat in settling times. The user must determine if the VC8E time delay is adequate for his scope. For slow scopes, in excess of 20 usec, software delays may be incorporated in his system or the user may change the 20 usec delay circuit by adding a larger capacitor for C24 on the M869 and determining the value from the 9601spec sheet.

C. Drive

Careful selection of cabling should be used. The X and Y outputs are capable of driving loads greater than 1K in parallel with 5000 pf of capacitance. That is, 100 ft. of cable at 50 pf/ft.

D. External Controls

The VR14 has a 2 channel input whereby the user can select a channel by setting a bit in the status register. This signal is usually not used by other scopes. However, the user may be able to use it as a pen up, pen down capability on an XY plotter. The output signal is zero to +5 volts with a 10 ma source at +5V and a 30 ma sink current at ground. This bit can also be as a signal for partially controlling a storage scope.

digital	FIELD SERVICE TECHNICAL MANUAL				Option or Designator
	12 Bit <input checked="" type="checkbox"/>	16 Bit <input type="checkbox"/>	18 Bit <input type="checkbox"/>	36 Bit <input type="checkbox"/>	VC8E

Title VC8E-LAB8E-USE AND MODIFICATION (CONT.)				Tech Tip Number VC8E-TT-1	
All	Processor Applicability		Author ^{G. Chaisson} A. Wallack	Rev 0	Cross Reference
	8E		Approval W. Cummins	Date 7-31-72	

E. Ground Logic

The analog signals that are present at the output of the VC8E are the analog voltages, the analog ground and the logic ground (shield). When using differential inputs, the analog voltage and analog gnd must be used. When using single ended inputs use only the analog voltage and logic gnd. At no time connect the analog gnd to the system ground. In other words, beware of ground loops.

F. VC8E Restrictions

1. The VC8E cannot control storage scopes fully. It can only plot points.
2. The VC8E can use two different IOT device codes 05 and 15.
3. Maximum of 2 VC8E controller in 1 system.

The responsibility to interface to various scopes will rest with the customer. Following these guidelines will enable the user to accomplish this successfully.

Title VC8E CABLES						Tech Tip Number VC8E-TT-2	
All Processor Applicability			Author Gary Budianski		Rev 0		Cross Reference
8E			Approval Dale Staupé		Date 4-6-74		

All VC8E Display Controls are shipped standard* with a P/N 7008499 10 foot general purpose scope interface cable. This assembly is supplied with one unterminated end for the User's Display, and a BERG Connector for attaching to the modules in the option.

Other cables are available, as shown below, and may be ordered through the Logic Products, September 1973, Cable Price List/Cross Reference Guide.

<u>CABLE</u>	<u>PURPOSE</u>
7008499-10	10 foot general purpose display cable
7008499-25	25 foot general purpose display cable
7008499-50	50 foot general purpose display cable
7008491-10	10 foot Tektronix RM503 display cable
7008977-10	10 foot Tektronix 611/613 display cable
BC01K-10	10 foot VR14 display cable
BC01K-25	25 foot VR14 display cable
BC01K-50	50 foot VR14 display cable
BC01K-A	100 foot VR14 display cable
BC01L-10	10 foot Tektronix 602/604 display cable
BC01L-25	25 foot Tektronix 602/604 display cable
BC01L-50	50 foot Tektronix 602/604 display cable
BC01L-A	100 foot Tektronix 602/604 display cable

*EXCEPTIONS

Systems with a VC8E option and a VR14 display, on the same Purchase Order, will receive a BC01K-10 cable instead. Systems with a VC8E option and a VM03 602 Mounting Assembly will receive the BC01L-10 cable, if both are requested on the same Purchase Order.

digital	FIELD SERVICE TECHNICAL MANUAL				Option or Designator
	12 Bit <input checked="" type="checkbox"/>	16 Bit <input type="checkbox"/>	18 Bit <input type="checkbox"/>	36 Bit <input type="checkbox"/>	VC8I

Title Extraneous Light Pen Interrupt				Tech Tip Number VC8I-TT-1		
All	Processor Applicability			Author	Rev 0	Cross Reference
	8I			Approval W. Cummins	Date 7-31-72	

If a VC8I is installed without the 370 Light Pen, it is necessary that D03V2 be grounded. If this point is allowed to float, extraneous interrupts will occur when instructions 6054 and 6064 are generated. Another source of this problem is faulty assembly of the M701 in that transistor Q5 is inserted into incorrect holes.

Title VC8I INSTALLATION NOTES				Tech Tip Number VC8I-TT-2		
All	Processor Applicability			Author	Rev 0	Cross Reference
	8I			Approval W. Cummins	Date 7-31-72	

- There are errors concerning the VC8I in the small computer handbook.
 - The intensify signals are variations in voltage level, not duration.
 - The A607 has an output of \emptyset to +2V, not \emptyset to -10V.
- The VC8I print (-0-1) indicates a reference voltage of -2 which is an error; reference voltage is -8V.
- | | | | |
|--------------|------|------|------|
| ADD MODULES | M701 | A607 | A607 |
| INTO 8I SLOT | HJ23 | HJ24 | HJ25 |
- The configuration diagram print 8I-0-24 (1-2-3-4) should be referenced to determine placement of the RM503 scope.
- VC8I less 370 Light Pen - cable is part #70-5772.
 VC8I with 370 Light Pen - cable is part #70-5771.
 - Connect wiring harness as shown in the wiring diagram below.
 - To supply -15V to Light Pen logic, connect H \emptyset 3B2 to D \emptyset 3B2.
 - D \emptyset 3V2 must not be grounded for Light Pen operation.

If the Light Pen option is field installed on the VC8I, a new bracket with the logic, pen, and LOK control will be supplied. This will replace the original bracket which is mounted beneath the RM503.

COMPANY CONFIDENTIAL

Title VC8I INSTALLATION NOTES (Continued)						Tech Tip Number VC8I-TT-2		
All	Processor Applicability					Author	Rev 0	Cross Reference
	8I					Approval W. Cummins	Date 7-31-72	

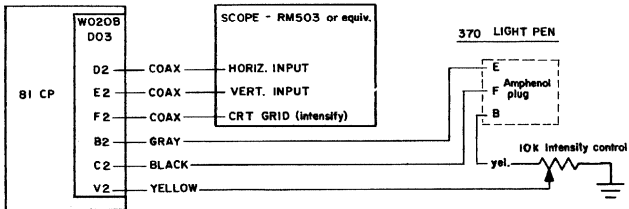

7) Checkout

- a) The VC8I provides intensify voltages suitable for the RM503 which may be inadequate for use with other scopes. A service scope and the following programs will allow verification of correct operation.

BEG 6074
6054
6075
6054
6076
6054
6077
6054
JMP BEG

D03F2(Z)

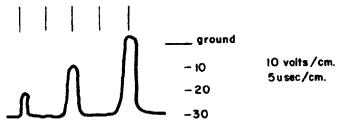

BEG 7200
7040
6052
6062
JMP BEG +1

D03D2(X)
D03E2(Y)



COMPANY CONFIDENTIAL

digital	FIELD SERVICE TECHNICAL MANUAL				Option or Designator
	12 Bit <input checked="" type="checkbox"/>	16 Bit <input type="checkbox"/>	18 Bit <input type="checkbox"/>	36 Bit <input type="checkbox"/>	VC8I

Title DISPLAYS VC8I				Tech Tip Number VC8I-TT-3	
All	Processor Applicability		Author Chaisson/Nunley	Rev 0	Cross Reference
	8I		Approval W. Cummins	Date 7-31-72	

Recently the VC8I intensity control module M701, Revision C, has been found to have been improperly produced. The problem is that a DEC 664 diode was installed for D9 instead of the proper DEC 670 diode. This problem exists on M701 etch revision C modules and can be corrected in the field by replacing D9 with the correct DEC 670 diode.

All spare modules should be checked for this problem and corrected before attempting to use them. Modules with this problem that are installed and used will be permanently damaged and no display will exist.

MODULES INSTALLED AND IN USE DO NOT HAVE THIS PROBLEM.

COMPANY CONFIDENTIAL

digital	FIELD SERVICE TECHNICAL MANUAL				Option or Designator
	12 Bit <input checked="" type="checkbox"/>	16 Bit <input type="checkbox"/>	18 Bit <input type="checkbox"/>	36 Bit <input type="checkbox"/>	VP8I
Title					Tech Tip Number
MODIFICATION OF CALCOMP PLOTTER CONTROL (M704)					VP8I-TT-1
All	Processor Applicability			Author	Rev 0
	8I			Approval W. Cummins	Date 7-31-72
					Cross Reference

Recently, difficulties have been experienced when attempting to set up the M704 delays associated with slow-motion instructions. The total duration of these delays should be approximately 70 ms to allow sufficient time for the drum to settle into position. The delay is set by a 1.2K potentiometer (R53), in series with a 220 ohm resistor (R52) on the M704. To allow R53 to adjust through a range of 60 to 80 ms, R52 must be changed to 680 ohms. The following illustrations are in reference to Engineering Drawings D-BS-VP8I-0-1 and D-CS-M704-0-1.

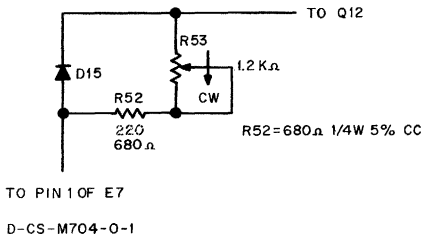
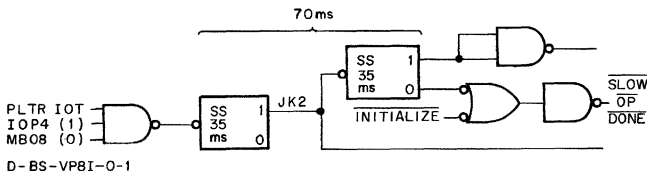

COMPANY CONFIDENTIAL

digital	FIELD SERVICE TECHNICAL MANUAL				Option or Designator
	12 Bit <input checked="" type="checkbox"/>	16 Bit <input type="checkbox"/>	18 Bit <input type="checkbox"/>	36 Bit <input type="checkbox"/>	VR12

Title				VOLTAGE BUS PROBLEMS		Tech Tip Number	VR12-TT-1
All	Processor Applicability				Author	Rev	0
	12				Approval	H. Long	Date 8-17-72
							Cross Reference

Voltage Bus Problems

If you are experiencing difficulties in connecting a display to the external display connector, or the use of the auto restart circuitry we suggest that a possible cause may be the absence of a wire for -15 volts from N27B2.

It has been brought to our attention that there are machines in the field with this wiring error. The W512 in slot N27 and the W603 in slot N26 will not function properly if N27B2 - N34B2 is not installed.

Title				INSTALLATION AND REMOVAL OF G917		Tech Tip Number	VR12-TT-2
All	Processor Applicability				Author	Rev	0
	12				Approval	H. Long	Date 8-17-72
							Cross Reference

Caution should be exercised when removing or replacing the G917 in the VR12. The plastic allen mounting screw when placed under pressure has a tendency to break off, ruining not only itself but the spacer also. If tightened just to the point of being snug, these plastic allen screws will serve their purpose, which is to center the adjustment screw not hold it in place, and not be as likely to cost you time locating replacement parts.

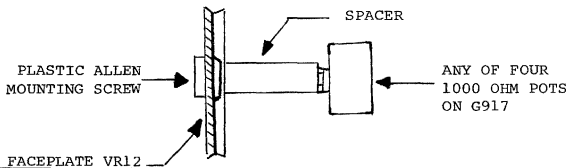

Title				POINT PLOT DISPLAY MAINTENANCE MANUAL		Tech Tip Number	VR12-TT-3
All	Processor Applicability				Author	Rev	0
	12				Approval	H. Long	Date 8-17-72
							Cross Reference

Parts list, page 7-9, item #37. A washer, flat nylon, #1D., 3/80 D X 1/32 thick. This part number is given as 90-06712. This number is incorrect. The corresponding washer for this number is too small. The correct part number is 96-06710.

COMPANY CONFIDENTIAL

Title				ECO VR12 - 00009		Tech Tip		VR12-TT-4			
All				Processor Applicability		Author		Rev 0		Cross Reference	
12						Approval		H. Long		Date 8-17-72	

This ECO does not include the part number for the new high voltage power supply. This part number is D-AD-7006261-0-0 and can also be ordered as an H712.

COMPANY CONFIDENTIAL

COMPANY CONFIDENTIAL

	FIELD SERVICE TECHNICAL MANUAL				Option or Designator VR14
	12 Bit <input checked="" type="checkbox"/>	16 Bit <input type="checkbox"/>	18 Bit <input type="checkbox"/>	36 Bit <input type="checkbox"/>	

Title WIRING ERRORS				Tech Tip Number VR14-TT-1		
All	Processor Applicability			Author	Rev 0	Cross Reference
	/2			Approval H.Long	Date 8-17-72	

Wiring Errors

The VR14 Point Plot Display uses a split winding 11/115 VAC power transformer. Several In-House units wired for 115 VAC have been found to have bad fast-on terminals on one-half of the primary winding, thus placing the entire load on the other half of the transformer.

THIS CONDITION IS DANGEROUS AND WILL SHORTEN UNIT LIFE

To check for this fault condition (only present in units wired for 110 or 115 VAC), disconnect the gray or white wire from TB-2 and the red or orange wire from TB1-3. Measure for continuity from TB1-6 to the LUG (NOT the encased wire) of the disconnected windings. A resistance reading greater than 5 OHMS indicates a poor or improper crimp. The contact should be recrimped or soldered to insure a good contact. Please report any instances of this problem directly to me.

Title FIELD ADD-ON PROBLEMS				Tech Tip Number VR14-TT-2		
All	Processor Applicability			Author	Rev	Cross Reference
	/2			Approval H. Long	Date 8-17-72	

When adding a VR14 to a PDP-12 which has a VR12 display, the A615 output must be checked prior to connecting the VR14. Load and start display, test, freeze the "X" pattern. Using an oscilloscope, check the output of the X and Y D-to-A converters (pins E37H2 and E36H2) for a negative sawtooth waveform varying from 0 to no more than -7 volts. If the A615 output does not fall within these limits, the VR14 will be overdriven and possible unit damage will result.

Title Power Heat Sink Semiconductors				Tech Tip Number VR14-TT-3		
All	Processor Applicability			Author	Rev 0	Cross Reference
	/2			Approval H. Long	Date 8-17-72	

Several VR14 displays were inadvertently shipped with 2N4398 power transistors in place of 2N4399's. All units should be checked for MOTOROLA 2N4399 (2 on each heat sink assembly) transistors.

Fairchild 2N4399's are ALSO NOT ACCEPTABLE- They have a poor life quality expectancy.

Title THERMAL RUNAWAY						Tech Tip Number VR14-TT-4		
All	Processor Applicability					Author	Rev 0	Cross Reference
	/2					Approval H. Long	Date 8-17-72	

Thermal Runaway

A possible thermal runaway condition exists in the VR14 power control board (G836 assembly). This is indicated by mysterious fuse blowing some, wiping out power transistors, etc.

The cure is to change the two regulator transistors, Q2 and Q4, and to change 4 resistors.

Q2: 2N4920 (15-9605)

Q4: 2N4934 (15-9604)

R10, R27, Are 150 OHM, Should be 10 OHM

R9 R24, Are 1 KOHM, Should be 270 OHM

To check it out, monitor the +22/-22 VDC supplies and heat the G836 with a hot air blower. If the voltage begins to climb, change the transistors again.

Title G836 TRANSISTORS						Tech Tip Number VR14-TT-5		
All	Processor Applicability					Author	Rev 0	Cross Reference
	/2					Approval H. Long	Date 8-17-72	

Some of the G836 power control boards used in the VR14 were shipped without thermal compound under the regulator transistors. If there is little or none of this compound between the transistor and its heat sink, it may go into a thermal runaway condition and cause damage to the deflection system. (reference, tech tip 2.6.3.4).

Do not use silicone grease in place of thermal compound; its thermal conductivity is just about β .

Title G836 ASSEMBLY						Tech Tip Number VR14-TT-6		
All	Processor Applicability					Author	Rev 0	Cross Reference
	/2					Approval H. Long	Date 8-17-72	

The power regulator control board, referenced elsewhere in this manual as a G836 assembly, is really a manufactured item as part number 70-7165.

Remember: Ordering a G836 will either get you an incomplete assembly (no Mate-N-Locks) or no parts at all. Order 70-7165 power regulator control!

COMPANY CONFIDENTIAL

digital	FIELD SERVICE TECHNICAL MANUAL				CPI Option or Designator
	12 Bit <input checked="" type="checkbox"/>	16 Bit <input checked="" type="checkbox"/>	18 Bit <input checked="" type="checkbox"/>	36 Bit <input checked="" type="checkbox"/>	VR14

Title G836 ETCH REVISION "E" PROBLEM				Tech Tip Number VR14-TT-7	
All X		Processor Applicability ..		Author B. O'Donnell Rev 0	
		Approval D. Starratt		Date 4/30/74	
				Cross Reference	

The VR14 Power Supply Regulator Assembly (7007165) consists of the following pieces:

- 1 - G836 - VR14 Power Supply Regulator Module.
- 1 - 7408439 - Mate-N-Lok Assembly Bracket

The above two items should normally be ordered as one part (7007165); however, the G836 can be obtained separately.

A problem has arisen on etch revision "E" only of the G836 module when the Mate-N-Lok Assembly Bracket (7408439) is attached. The etch runs on the "E" rev. modules were extended too far up the board causing shorts when the brack and module are assembled.

An ECO has been written (7007165-0002) to the Regulator Assembly to add fiber washers (9006693), quantity four (4), between the Mate-N-Lok brack and the G836 Etch Rev. "E" module. In general this has been done, however, some assemblies have slipped through to the field and could result in shorting 400 volts to ground. In addition, since it is possible to obtain the G836 etch revision "E" as a separate part; one should remember to install the 4 fiber washers (9006693) when assembling the Mate-N-Lok bracket to the module.

-- NOTES --

digital	FIELD SERVICE TECHNICAL MANUAL				Option or Designator
	12 Bit <input checked="" type="checkbox"/>	16 Bit <input checked="" type="checkbox"/>	18 Bit <input type="checkbox"/>	36 Bit <input type="checkbox"/>	VR20

Title HIGH VOLTAGE ARC-OVER				Tech Tip Number VR20-TT-1	
All		Processor Applicability		Author	Rev 0
				Approval H. Long	Date 8-17-72
				Cross Reference	

High voltage ARC-OVER, usually occurring inside the high voltage regulator may be caused by contamination of the porcelain standoff insulators. Some insulators were assembled with metal screwdrivers, and the inside of the insulator may have been scratched

If ARC-OVER does occur, disassemble the regulator assembly and visually inspect the interior of the standoffs for scratches metal deposits, etc. If they are damaged, simple cleaning of the insulator with soap and water may cure the problem. Otherwise, they must be replaced.

The correct part number is 12-10594

Needless to say, they should be disassembled and reassembled with only non-metallic screwdrivers. These are available from the field service stockroom on special order, or preferably local purchase.

Title VR20 INSTALLATION AND P.M. CHECK				Tech Tip Number VR20-TT-2	
All		Processor Applicability		Author Jeff Blundell	Rev #
				Approval	Date 7/9/73
				Cross Reference	

Shipping hazards and customer site environmental conditions may cause internal damage to the high voltage switch (H.V.S.) circuit (7008471) of the VR20 color point plot display.

Conditions have arisen, in the field, which dramatize the need for a thorough examination of the H.V.S. circuit for possible component defects and/or dirt build up. Component breakage or excessive dust can cause arcing within the H.V.S. circuit resulting in even greater damage effective over an extended period of time. What follows is a description of the most common H.V.S. problems:

A. COMPONENT BREAKAGE

There are four (4) long 20 Megohm resistors in the H.V.S. circuit used as the series leg of a voltage divider/regulator network. Due to extreme vibrational shock, one or more of these resistors may crack resulting in a potential drop of between 5 and 10 KV. across the crack of the broken resistor(s).

This difference of potential across the crack can cause arcing to occur. There arcs tend to enlarge the crack causing an even greater

COMPANY CONFIDENTIAL

Title					VR20 INSTALLATION AND P.M. CHECK		Tech Tip Number		VR20-TT-2	
All		Processor Applicability			Author		Jeff Blundell		Rev	
		8s11s12			Approval		Date		Cross Reference	

danger to the scope. This situation, depending upon the position of the break on the resistor, may extend to the resistor bracket ultimately causing damage to the H.V.S. cabling.

B. EXCESSIVE DIRT

Dirt under certain instances, can act as a path of conductance. It can be seen; therefore, that arcing may occur across a path of dust particles which may cause indeterminate damage to the scope.

Keeping the above problems in mind, it has become necessary to initiate a special check which should be performed at every installation and preventive maintenance:

1. Remove the high voltage switch box per the procedure listed in the VR20 User's Manual (DEC-12-HRSA-D) section 4.4.3.
2. Remove the bottom cover of the H.V.S. box.
3. Insure the H.V.S. circuit has discharged completely by clipping a ground lead first to the H.V.S. box chassis and then to all exposed areas of the H.V.S. circuit.

CAUTION: Use only one hand when performing the above step.

4. Clean the entire H.V.S. box of all dirt build up.
5. Observe the contents to check for broken or hairline cracked components.
6. If any breaks are observed, replace the entire H.V.S. assembly (7008471).
7. Install the good H.V.S. assembly per the reverse order of the above procedure steps 1 and 2.

COMPANY CONFIDENTIAL

digital	FIELD SERVICE TECHNICAL MANUAL				Option or Designator
	12 Bit <input checked="" type="checkbox"/>	16 Bit <input checked="" type="checkbox"/>	18 Bit <input type="checkbox"/>	36 Bit <input type="checkbox"/>	VR20

Title VR20 PREVENTIVE MAINTENANCE CHECK				Tech Tip Number VR20-TT-3	
All		Processor Applicability		Author Brian O'Donnell Rev 0	
8	11	12		Approval Al Shimer	Date 8/16/73
				Cross Reference	

In the VR20, there is only a minimum area separating the High voltage switch box (7008471) and the input voltage tabs on the high voltage supply (7008458).

The high voltage switch box is suspended over the high voltage supply tabs stabilized only from one side by two (2) screws connected through 1.6 inch stand offs.

Four (4) wires, originating from a terminal block mounted inside the VR20 chassis, are connected to the high voltage supply tabs. The routing and/or length of these wires in relation to the high voltage switch box has caused reason for concern in recent months especially in systems exhibiting excessive vibration.

The combination of the above factors (wire routing and high voltage switch box susceptibility to vibration) might result in conductor insulation wear which could cause major electrical damage to both the high voltage supply and high voltage switch box. In order to avoid the possibility of such damage, the following steps should be performed at every VR20 P.M.:

1. Remove the high voltage switch box as described in paragraph 4.4.3 of the VR20 User's Manual (DEC-12-HRSA).
2. Observe the wires to and around the high voltage supply. Check for:
 - a) wire insulation wear;
 - b) solder connections to the high voltage tabs;
 - c) crimped connections to the terminal block inside the VR20 chassis;
 - d) wire routing to the high voltage supply. Insure the wire path is such that any switch box vibration will not cause wire deterioration.
3. Repair or replace those items where deemed necessary.
4. Replace the high voltage switch box insuring a secure mount. (Refer to step 1 above).

-0-0-0-0-0-0-0-0-

COMPANY CONFIDENTIAL

-- NOTES --

digital	FIELD SERVICE TECHNICAL MANUAL				Option or Designator
	12 Bit <input checked="" type="checkbox"/>	16 Bit <input checked="" type="checkbox"/>	18 Bit <input checked="" type="checkbox"/>	36 Bit <input type="checkbox"/>	VT01

Title	ERASE RETURN PROBLEM			Tech Tip Number	VT01-TT-1
All	Processor Applicability	Author	Al Shimer	Rev	0
X		Approval	Larry Lewis	Date	1/74
					Cross Reference

The VT01 (Tektronix 611) storage scope requires 400-500 ms. to erase. However, an additional 400-500 ms. recovery time is required before a second erase can be issued. Writing can be resumed when ready sets at the end of the erase interval, but if a second erase is issued within 400-500 ms. after completion of the first, the erase interval one shot in the VT01 will not respond. The result is erase signal constantly asserted, VT01 will not perform the second erase nor assert return, and ready flag will not come true again. Pushing the erase button the scope will erase and restore ready. The problem has not been serious because there is no reason for back to back erases ever being programmed.

Since a service call could be logged for this problem, the Engineer should be able to explain the limitation of the Tektronix equipment in this regard.

-- NOTES --

digital	FIELD SERVICE TECHNICAL MANUAL				Option or Designator
	12 Bit <input checked="" type="checkbox"/>	16 Bit <input checked="" type="checkbox"/>	18 Bit <input type="checkbox"/>	36 Bit <input type="checkbox"/>	VT05

Title VT05 - 8 FAMILY INTERCONNECTIONS				Tech Tip Number VT05-TT-1	
All Processor Applicability		Author B. Nunley	Rev 0	Cross Reference	
8's		Approval W. Cummins	Date		

Current mode, local TTY: (Cable may be up to 1800 feet in length.)

Pin Assignment

W076D

3
4
7
6

MATE-N-LOCK 8 PIN

3 Data Out
7 Return
2 Data In
5 Return

EIA:

Interface

PT08F, PT08FX
DC02
PT08B, PT08C

Cable

705717
BC01A
BC01C or BC01J

(Total Length must be less than 50 feet)

25 feet standard
25 feet standard
25 feet standard

Cables

705717 - W023 to 25 pin amphenol

BC01A & BC01C - must go through H308 or H312 null modem or swap pin 2 and 3 for correct transmit-receive wiring.

BC01J - M850 to 25 pin amphenol connect directly between VT05 and PT08B or PT08C.

Title HIGH SPEED/50HZ OPERATION				Tech Tip Number VT05-TT-2	
All Processor Applicability		Author W. Cummins	Rev 0	Cross Reference	
X		Approval W. Cummins	Date 07/06/72		

Prior to ECO M7001-00005, the M7001 was not compatible with the high speed option M7004. Also, when adapting a VT05 to 50 Hz use, a vertical synch problem developed after jumpers W4 and W6 were changed.

ECO M7001-00005 makes the M7001 and M7004 compatible and adds a 300 pf cap from E6 pin 6 to ground to eliminate the synch problem.

Title		VT05 MAINTENANCE MANUAL ERROR				Tech Tip Number		VT05-TT-3		
All	Processor Applicability				Author	Rev		0		Cross Reference
X					Approval	H. Long	Date	08/02/72		

There is an error in the VT05 manual page 1-8 (DEC-00-H4AB-D) and in the engineering specification sheet 7 of 36 (A-SP-VT05-29) with respect to the current mode (20 ma) mate-n-lock plug pin assignments. The table should be as shown below:

PIN NUMBER	DESCRIPTION	OTHER NOTATIONS
1	Unassigned	Unassigned
2	Received Data*	Display -
3	Transmotted Data*	Keyboard -
4	Reserved	Reserved
5	Received Data	Display +
6	Reserved	Reserved
7	Transmitted Data	Keyboard +
8	Reserved	Reserved

* Pins 2 and 3 are more negative referenced to pins 5 and 7.

Title		KEYBOARD SHORTS CAUSED BY PAPERCLIPS, ETC.				Tech Tip Number		VT05-TT- 4		
All	Processor Applicability				Author	Rev		0		Cross Reference
X					Approval	W. Cummins	Date	11/20/72		

COMPANY CONFIDENTIAL

digital	FIELD SERVICE TECHNICAL MANUAL				Option or Designator
	12 Bit <input checked="" type="checkbox"/>	16 Bit <input checked="" type="checkbox"/>	18 Bit <input checked="" type="checkbox"/>	36 Bit <input checked="" type="checkbox"/>	VT05

Title				VT05 Interconnections		Tech Tip Number		VT05-TT-5	
All	Processor Applicability			Author		J. Alston/ O. Josbacher		Rev A	
X				Approval		B. Dimbat		Date 6/1/73	
				Cross Reference					

1. Current mode (20 ma)

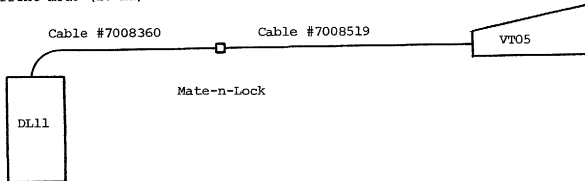

+XMIT	AA	(White)	5	(White)	5	REC
-RET	KK	(Black)	2	(Black)	2	RET
+REC	K	(Green)	7	(Green)	7	XMIT
-RET	S	(Red)	3	(Red)	3	RET

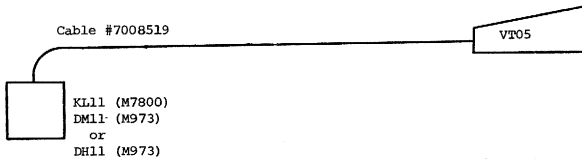

+XMIT	Cl	5	(White)	5	REC
-RET	Dl	2	(Black)	2	RET
+REC	Jl	7	(Green)	7	XMIT
-RET	Ml	3	(Red)	3	RET

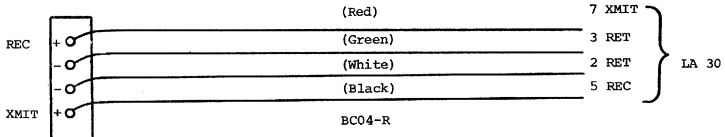

DJ11-H317A
Dist. Panel

COMPANY CONFIDENTIAL

Title VT05 Interconnections (cont.)										Tech Tip Number VT05-TT-5					
All Processor Applicability										Author J. Alston / O. Josbacher		Rev A		Cross Reference	
X										Approval B. Dimbat		Date 6/1/73			

2. EIA level

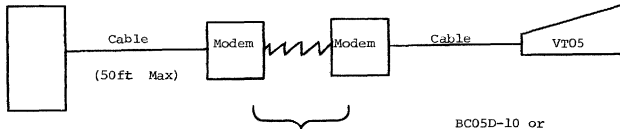

-Null Modems- *
H308 or H312 May
be substituted

BC05D-10 or
BC05-D-25
(Not Supplied)

- DL11 BC05-C (Supplied)
- DC11 BC01-R (Supplied)
- EM11 BC01-R (Supplied)
- DJ11 BC05-D (Not Supplied)

* IMPROVING NULL MODEM H312 - VT05 COMMUNICATION

- A. Some software systems are not working when system interface connects to VT05 by way of Null Modem. To correct this: Use M7004 Module revision J or newer and add wire from pin 20 to pin 4 on EIA interface connector (DEC P.N. 12-05886) on the back of the VT05. Pin 4 will now provide the REQUEST TO SEND signal from the VT05. This prevents the carrier detect line from floating.
- B. Outside of the U.S.A. if the Null Modem connects to a CCITT line (over-sease equivalent to EIA), operation may be marginal because of too much a voltage drop across resistors R83, R84, and R85 on Module M7004. To correct: Replace the three 5.6K resistors R83 through R85 with 3.9K resistors.

COMPANY CONFIDENTIAL

digital	FIELD SERVICE TECHNICAL MANUAL				Option or Designator
	12 Bit <input checked="" type="checkbox"/>	16 Bit <input checked="" type="checkbox"/>	18 Bit <input type="checkbox"/>	36 Bit <input type="checkbox"/>	VT05

Title VT05 ALPHANUMERIC DISPLAY TERMINAL GENERAL SERVICE TIPS					Tech Tip Number	VT05-TT-6
Processor Applicability			Author OSI JOBACHER	Rev		Cross Reference
All			Approval FRED DOLL	Date 6/11/73		

A. VT05 SERVICE PHILOSOPHY

Although VT05 service philosophy calls for module and assembly swap it is good economy to spend a few minutes on certain modules and assemblies to which a problem has been traced, to check if any definite component can be determined defective. In some cases, this may enable on-site repair. For example, the crystals used on the M7001 and M7004 modules are available from stockrooms and they can easily be replaced, or by following LK01- TECH TIP-2 certain repairs can be done on the keyboard. If your findings are recorded on the module tag it will speed up the repair at the DEPOT.

B. The circuit breaker used on Sylvania monitors, sometimes, when tripped cannot be reset. The reason: the frame of the breaker is slightly bent and the plunger can not latch up. It's usually easy to bend the frame back in to shape by hand.

C. VT05 INCOMPATIBILITY

The VT05 is not software compatible with the TTY at higher baud rate transfer. Between 600 and 2400 baud filler characters must be added when doing any of the following operations:

- Line Feed (ASCl1 212)
- Home (ASCl1 235)
- Cursor Up (ASCl1 232)
- Cursor Down (ASCl1 213)
- Erase Screen (ASCl1 237)
- Y address is direct
- Cursor addressing

A filler character is defined as a non print character; rubout (ASCl1 377) is recommended. The necessary number of filler characters required are:

<u>BAUD RATE</u>	<u>FILL CHARACTERS REQUIRED</u>
600	One (1)
1200	Two (2)
2400	Four (4)

COMPANY CONFIDENTIAL

Title VTO5 ALPHANUMERIC DISPLAY TERMINAL GENERAL SERVICE TIPS						Tech Tip Number		VTO5-TT-6			
All		Processor Applicability				Author OSI JOSEBACHER		Rev		Cross Reference	
X						Approval FRED DOLL		Date 6/11/73			

D. CABLE RESTRICTIONS

Using the 20 m A current loop the maximum allowable cable length between the VTO5 and the connecting device is 250 feet at 2400 baud
500 feet at 1200 baud
1000 feet at 600 baud
and 2000 feet up to 300 baud

For EIA operation a maximum cable length of twenty five (25) feet may be used.

* * * * *

E. CRYSTALS USED ON M7003 AND M7004 MODULES

The DEC part number for this crystal is 18-10245-1. Presently, we purchase these crystals from two different vendors. The one vendor has the number VR6 punched on the case. The other vendor has NE-6-C on the case.

WARNING: You may find crystals with the number NE-6-D. This crystal should NOT be used and all stockrooms have been purged from it. If you find one, throw it out.

* * * * *

F. KEYBOARD

ECO VTO5-0061 adds parts list and assembly drawing to the print set.

G. The transistors under the keys of the keyboard are NPN type A1015A the DEC part number is 15-10948. The part number for the keyboard ROM is 21-11047. The vendor numbers on the ROM are AY5-2376 P.N. 0017 for General Instruments and KR2376-17 for Standard Microsystems. NOTE the number 17 or 0017 denotes the ROM is designed for the VTO5 application. If this number is missing on the ROM even if the first part of the number is correct the ROM is questionable. Sometimes only the P.N.0017 appears on the ROM, this should be O.K.

* * * * *

COMPANY CONFIDENTIAL

digital	FIELD SERVICE TECHNICAL MANUAL				CPI Option or Designator
	12 Bit <input type="checkbox"/>	16 Bit <input checked="" type="checkbox"/>	18 Bit <input checked="" type="checkbox"/>	36 Bit <input checked="" type="checkbox"/>	VT05

Title VT05 ALPHANUMERIC DISPLAY TERMINAL GENERAL SERVICE				Tech Tip Number VT05-TT-6	
Processor Applicability				TIPS	
All	Author OSI JOSBACHER		Rev		Cross Reference
X	Approval FRED DOLL		Date 6/11/73		

H. The CRT

When working on or near the CRT, it is advisable to wear safety goggles. The DEC part number is 29-16141.

1. The CRT screen and the filter in front of the screen must be cleaned regularly in order to ensure clear vision. The intensity should be adjusted as low as possible to avoid burning the CRT with a high intensity beam. The cleaning interval usually depends on the environment.

J. Instruct your VT05 users to adjust the contrast and brightness control in the following manner:

1. Display characters across the screen.
2. Turn the contrast down to a point where the characters can just be identified.
3. Turn the brightness down to the point where the background trace disappears.
4. Turn the contrast up just enough to read the characters clearly.

NOTE: Avoid excessive contrast and brightness.

* * * * *

K. WAVY OR JITTERY HORIZONTAL OR VERTICAL LINES

There have been several cases when wavy lines were caused by the wiring to the flyback transformer. Sometimes the wires to the primary are excessively long and are getting too close to the insulation of the coil of the flyback transformers where high voltage arcing may occur. The arcing cannot necessarily be observed in a fully lighted room but you may smell the ozone, a strong odor caused by the electrical discharge. Route the wires neatly and use a drop of glue here and there to fasten the wires down. The heavily insulated high voltage wire from the secondary of the flyback transformer to the CRT occasionally cause trouble when they are too close to the chassis or too close to the coil. Carefully route this wire with a non-conductive rod while watching the screen.

* * * * *

L. GENERAL

If you find broken wires to the MATE-N-LOCK connector at the back of the VT05 attach a strain relief (tie-wrap) from the screw in the bottom center.

COMPANY CONFIDENTIAL

Title VT05 ALPHANUMERIC DISPLAY TERMINAL GENERAL SERVICE TIPS						Tech Tip Number VT05-TT-6	
Processor Applicability				Author OSI JOBACHER		Rev	
All						Cross Reference	
X						Approval FRED DOLL Date 6/11/73	

to the wires coming from the MATE-N-LOCK connector.

M. On certain VT05 installations where the sun beats down on the terminal for hours during the day, and a slight noise increase would meet no objections, it may be advisable to replace the standard 50 CFM fan with a 115 CFM fan. The part number is 12-9403-1.

* * * * *

Title VT05 RASTER DISPLAY ADJUSTMENT FOR MOTOROLA MONITOR						Tech Tip Number VT05-TT-7	
Processor Applicability				Author OSI JOBACHER		Rev	
All						Cross Reference	
X						Approval FRED DOLL Date 8/27/73	

NOTE: Component locations are described when unit is viewed from the front of the VT05. An oscilloscope should be available for the following adjustments. Throughout the following procedure stay clear of the (toroid) flyback transformer and HIGH VOLTAGE CRT (cathode ray tube) connection.

1. 73 VOLT REGULATOR ADJUSTMENT

Connect probe to the lower end of R79, a square shaped resistor of 10 watts, 105 ohms (in some units 150 ohms), which is mounted on the upper right side of the chassis. Adjust pot R74 (73V. REG. located on the front, right side of the printed circuit board) to 73 volts.

2. VIDEO BIAS ADJUSTMENT

Connect probe to wire wrap pin 7 on right side of printed circuit board and adjust bias pot R10 (located under the neck of the CRT) for a voltage of around 25 to 28 volts. Then, examining a full screen of E's, do final adjustment for best (even) display of the characters, similar to that of the focus adjustment.

3. FOCUS ADJUSTMENTS (DOT SIZE AND SHAPE)

For focus adjustment use pattern B of VT05 diagnostic and set focus pot R17 (on the left rear of P.C. board) for best overall focus.

4. VERTICAL SIZE (HIGHT) ADJUSTMENT

Look at a full screen of characters and adjust R65 (located in the center rear of the P.C. board) for a hight of $6\frac{1}{2}'' \pm \frac{1}{4}''$ (16 cm \pm 0.6 cm) for 20 lines of characters. If linearity is bad do the following adjustment first.

5. VERTICAL LINEARITY ADJUSTMENT

Turn-on VT05 test pattern (switch S1 on VT05 Bus Board). Check for vertical linearity. If necessary adjust R59 (located forward from vertical size pot). Recheck vertical size again (step 4 of this procedure).

COMPANY CONFIDENTIAL

digital	FIELD SERVICE TECHNICAL MANUAL				Option or Designator
	12 Bit <input checked="" type="checkbox"/>	16 Bit <input checked="" type="checkbox"/>	18 Bit <input checked="" type="checkbox"/>	36 Bit <input checked="" type="checkbox"/>	VT05

Title VT05 RASTER DISPLAY ADJUSTMENT FOR MOTOROLA MONITOR				Tech Tip Number VT05-TT-7	
All	Processor Applicability	Author OSI JOSBACHER	Rev	Cross Reference	
X		Approval FRED DOLL	Date 8/27/73		

6. WIDTH ADJUSTMENT

Set up display as in step 4 (vertical size adj.). Adjust L1 (the coil in the square shaped can in the center left of the P.C. board) to spread lines of 72 characters over 8" \pm $\frac{1}{4}$ " (20.4 cm \pm 0.6 cm) width across the screen.

NOTE: For adjustment 6 and 7 use a non-metallic hexagon calibration tool. The two adjustments are interactive, therefore, re-check the other when one is done.

7. HORIZONTAL LINEARITY ADJUSTMENT

Look for proportional length of all bars on letter E displayed across the screen. Adjust coil L3 diagonally mounted on left side of chassis.

Re-check with various other characters displayed.

8. DISPLAY CENTERING ADJUSTMENT

(Refer to A.2.2 page A-5 of the addendum to Volume 1 of the VT05 Alphanumeric Display Terminal, Maintenance Manual).

- a) Position the deflection yoke as far forward as possible against the flare on the neck of the CRT, and turn left or right as required to level the displayed lines.
- b) Turn-on VT05 test pattern (switch S1 on VT05 Bus Board).
- c) Turn-up brightness to the point where the raster becomes visible.
- d) Rotate the two beam-centering ring magnets (located on the yoke collar), individually or together, until the displayed raster (not the text) is centered.
- e) Re-check step 3 through 7.

COMPANY CONFIDENTIAL

Title FOAM STRIP ON ALL MONITORS						Tech Tip Number VT05-TT-8		
Processor Applicability						Author OSI JOSBACHER Rev		Cross Reference
All X						Approval FRED DOLL	Date 8/27/73	

When replacing a Raster Display (Monitor) be sure to remove the foam rubber strip from the rear cross member of the chassis of the used display and stick it on to the new display. All monitors must have the foam strip for the Modules to rest on.

If for some reason a new foam strip should be required order 11 1/2 inches (29 cm) of foam rubber P.N. 90-08214 or a multiple thereof to be prepared for future needs. If you wish to purchase the strip locally look for 11 1/2 inches long, 3/4 inches (2cm) wide and between 1/2 to 1 inch (1.3 to 2.6 cm) thick foam.

Title UNSTABLE VOLTAGE REGULATOR AND/OR VERTICAL JITTER ON MOTOROLA MONITORS						Tech Tip Number VT05-TT-9		
Processor Applicability						Author OSI JOSBACHER Rev		Cross Reference
All X						Approval FRED DOLL	Date 11/29/73	

B + regulator instability and/or VERTICAL JITTER which usually occurs on the bottom half of the screen and affects the horizontal raster lines may be caused by poor contact inside the REG. ADJ. potentiometer R74 or the VERTICAL SIZE potentiometer R65.

Poor contact is caused by flux which gets inside the pots during wave soldering at Motorola or it may be caused by a cleaner - lubricant used by Motorola to clean out the flux after soldering. The problem shows up intermittently and can frequently be corrected by the user tapping the VT05 shell. It may not re-occur for days or even weeks.

Motorola has corrected this problem at their end by sealing off the holes in the P.C. board before the wave soldering process.

To cure the problem at our end spray "MILLER STEPHENSON'S MS160" solvent DEC part number 29-20985 through the rectangular opening on the top of the potentiometer using an extension nozzle with its end cut to a wedge like tip. Flush the inside of the potentiometer real well and work the control several times through its full range. Repeat the whole process once or twice and readjust the control for proper VERTICAL SIZE or REGULATOR ADJUSTMENT, whichever applies.

NOTE: Disconnect the VT05 from AC power when cleaning the pot(s), and do not use any substitute to MS160, if you would you are bound to have re-calls possibly only after 2 or 3 weeks.

COMPANY CONFIDENTIAL

digital	FIELD SERVICE TECHNICAL MANUAL				Option or Designator
	12 Bit <input checked="" type="checkbox"/>	16 Bit <input checked="" type="checkbox"/>	18 Bit <input checked="" type="checkbox"/>	36 Bit <input checked="" type="checkbox"/>	VT05

Title NON COMPATIBLE KEYBOARD ROM'S					Tech Tip Number VT05-TT-10
All	Processor Applicability		Author Osi Josbacher	Rev	Cross Reference
X			Approval Fred Doll	Date 1/7/74	

Bad ROM's on keyboards below revision F can only be replaced with one made by GI (General Instrument Company). The GI part number is AY5-2376-0017. The DEC part number (21-11047) is also used for ROM's made by SMC which don't work on older keyboards.

Title LONGER SCREWS FOR VT05 NYLON FEET					Tech Tip Number VT05-TT-11
All	Processor Applicability		Author Bill Connors	Rev	Cross Reference
A			Approval Fred Doll	Date 1/18/74	

The 1/4" x 20 x 3/8" nylon screws used as fastener for the feet on the VT05 are too short to reach the recessed threads in the new plastic base castings. The specifications for the screw have been changed and in the future if you order screws using the original part number 12-10582, you will receive the new longer size (1/4" x 20 x 3/4").

COMPANY CONFIDENTIAL

-- NOTES --

CPX

digital	FIELD SERVICE TECHNICAL MANUAL				Option or Designator VT06
	12 Bit <input type="checkbox"/>	16 Bit <input checked="" type="checkbox"/>	18 Bit <input type="checkbox"/>	36 Bit <input type="checkbox"/>	

Title VT06 - MODEM COMPATIBILITY PROBLEM				Tech Tip Number VT06-TT-1		
All 8's	Processor Applicability			Author W. Freeman	Rev 0	Cross Reference
				Approval W. Cummins	Date	

Care must be taken when installing a VT06 to a modem other than a Bell 103A. In particular, terminals 11 and 12 of the VT06 are used for Reverse Channel Transmitted Data and Reverse Channel Receive Data respectively. In a 103F these terminals are used for Originate Mode and Local Mode respectively. Therefore, the VT06 will not operate on a 103F without removing the wires attached to pins 11 and 12 in the cable. Other problems may exist with different modems. It would be wise to check the terminal connections of the modem with that of VT06 (in users manual, page 31) to assure no mating connections will cause a problem.

Title VT06-Cabling				Tech Tip Number VT06-TT-2		
All X	Processor Applicability			Author	Rev 0	Cross Reference
				Approval H. Long	Date 08/02/72	

There have been some cabling problems encountered during installation of VT06's to DC02's and DP12's. Hopefully, the information given below will help iron out the difficulties.

1. A BC01A is the cable intended for use with a modem or null modem. It should come wired with the TRANSMIT and REC lines crossed over. These lines will be crossed again internally in the modem so that they end up correctly at the VT06.
2. A BC01J should not have the TRANSMIT and REC lines crossed. It is intended for use without a modem or null modem. Apparently, some have gotten into the field wired like a BC01A. Make this correction by switching the wires on pins 2 and 3 at either the paddle board or the cinch connector, so that the lines run straight through.
3. H312 null modems may still be on the drawing board and therefore not available immediately. The idea of a null modem is to facilitate switching from the VT06 to a data phone hookup with out having to change cables. If a data phone hookup is not likely to be used, then a BC01J should be connected directly to the terminals extender cable.
4. Some of the extender cables for the VT06 have been found to lack the run from J9 pin 20 to pin 1 of the cinch (Data Terminal Ready). If it is necessary, the connection can be made with one of the unused wires in the cable.

COMPANY CONFIDENTIAL

Title VT06 Cabling (continued)						Tech Tip Number VT06-TT-2		
All	Processor Applicability					Author Rev 0		Cross Reference
x						Approval H. Long Date 8/2/72		

5. For checking any hookup, continuity should be established between the points listed in the following chart.

VT06	J9		SPLIT Pins on M85Ø
Data terminal ready	20	to	1 (+5)
Xmitted Data	2	to	2 (REC)
Received Data	3	to	3 (Transmit)
			4 (N.C.)
GRD	1&7	to	5 GRD

Title VT06 Keyboard Switches						Tech Tip Number VT06-TT-3		
All	Processor Applicability					Author R. Boehm Rev 0		Cross Reference
x						Approval W. Cummins Date 10/20/72		

The VT06 was manufactured with two different keyboards. One keyboard has round switches with the vendor part number KB-01-01 (made by GRI) on the switch. This cross references to DEC part number 29-16904. The other type keyboard has square switches with no number on the switch. The vendor part number for this switch is 29-10 (made by CTC) which cross-references to DEC part number 29-20171.

Round Switch - Part Number 29-169Ø4
Square Switch- Part number 29-2Ø171

COMPANY CONFIDENTIAL

CPL

digital	FIELD SERVICE TECHNICAL MANUAL				Option or Designator
	12 Bit <input checked="" type="checkbox"/>	16 Bit <input checked="" type="checkbox"/>	18 Bit <input type="checkbox"/>	36 Bit <input type="checkbox"/>	VT20

Title				Tech Tip	
M7008 ECO#3				Number VT20 #1	
All Processor Applicability		Author John Gleeson		Rev 0	
11's 8's		Approval George Chaisson		Date 1/16/74	
Cross Reference					

This ECO will include, as one of the changes, removal of the "blinking" feature of the cursor. This apparently causes user problems while in the "Cursor Move" mode. It is not of a sufficiently troublesome nature to warrant retro-fitting; the problem will be corrected if the M7008 is replaced by an E Rev board during a service call. However, if one VT20 at a site is fixed, the customer may ask that all his VT20's have the problem corrected. If this happens, this portion of the ECO can be installed very simply, as follows -

- a. Cut the etch to E80 pin 1.
- b. Wire Pins 1 and 2 of E80 together.

-- NOTES --

digital	FIELD SERVICE TECHNICAL MANUAL				Option or Designator
	12 Bit <input checked="" type="checkbox"/>	16 Bit <input type="checkbox"/>	18 Bit <input type="checkbox"/>	36 Bit <input type="checkbox"/>	W076

Title TELETYPE CONNECTOR W076			Tech Tip Number W076 TT#1		
All Processor Applicability		Author		Rev 0	
8L 8L		Approval W. Cummins		Date 7-31-72	
			Cross Reference		

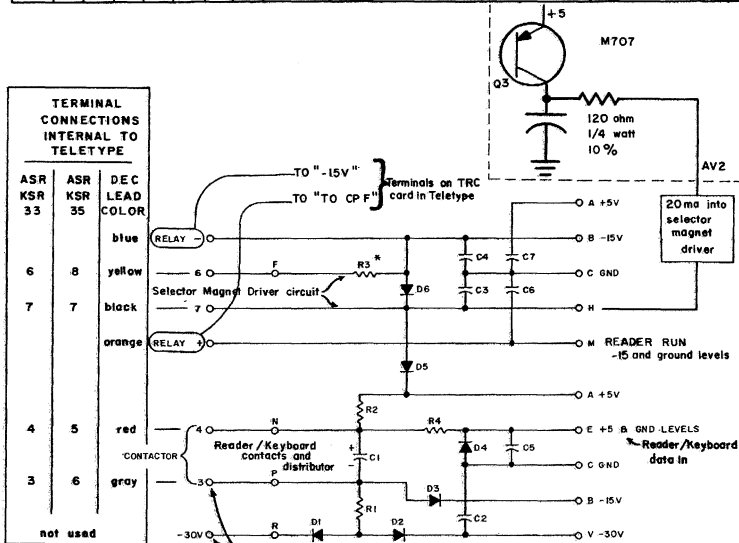

TERMINAL CONNECTIONS INTERNAL TO TELETYPE		
ASR KSR 33	ASR KSR 35	DEC LEAD COLOR
6	8	yellow
7	7	black
		orange
4	5	red
3	6	gray
not used		

seven split lugs on W076
* R3 changed to 820 ohm 1/2 watt 20%

R3	RES. 1K 1/2W 10% CC	1302187
R4	RES. 750 1/2W 5% CC	1300354
R2	RES. 750 2W 5% CC	1301984
R1	RES. 1K 1W 10% CC	1301499
D4	DIODE D664	1100114
D1, D2, D3, D5, D6	DIODE D671	1103309
C2 - C7	CAP. .01MFD 100V 20% DISC	1001610
C1	CAP. 1MFD 150V 10% FOIL	1000063

REFERENCE DESIGNATION	DESCRIPTION	PART NO.
PARTS LIST		

TRANSISTOR & DIODE CONVERSION CHART			
DEC	ISA	DEC	ISA
D664	IN3508		
D671	IN3553		

digital		TITLE	
CORPORATION		TELETYPE CONNECTOR W076	
SIZE	CODE	NUMBER	REV
B	CS	W076-0-1	A
PRINTED CIRCUIT REV		B	

Title New Teletype Connector Module for Compatability						Tech Tip Number W076-TT-2		
All Processor Applicability						Author B. Harrigan Rev 0		Cross Reference LT33 & LT35
						Approval W. Cummins Date 7-31-72		

A W076, revision "D", connector module, has been designed to accommodate both positive and negative logic and Teletypes equipped with this new module will be interchangeable throughout the PDP-8, 9 and 12 families.

Formerly, a W070 was required for operating a Teletype with a PDP-8, 8S, or PDP-9; PDP-8I and 8L have utilized earlier revisions of the W076.

A TELETYPE WITH THE W076 D SHOULD NOT BE CONNECTED TO A PDP-8 UNTIL THE IMPLEMENTATION OF ECO 8M-00004 IS ASSURED.

IF A CHAIN OF GROUNDS IS PRESENT IN THE PDP-8 MEMORY WING, THE W076 D WILL BE SHORT CIRCUITED AND DAMAGED WHEN POWER IS APPLIED.

The "ADD/DELETE" list for ECO 8M-00004 is as follows:

Delete MF30C to MF30F	Delete MF30L to MF30N
Delete MF30F to MF30J	Delete MF30N to MF30R
Delete MF30J to MF30L	Delete MF30R to MF30U

The removal of these grounds, if they are present, will eliminate the problem and proper operation may be expected.

Title NEW TELETYPE CONNECTOR MODULE FOR COMPATABILITY						Tech Tip Number W076-TT-3		
All Processor Applicability						Author Steve Lamotte Rev A		Cross Reference
X						Approval H. Long Date 09/14/72		

A W076, Revision "D", connector module has been designed to accommodate both positive and negative logic, and Teletypes equipped with this new module will be interchangeable throughout the PDP-8, 9 and 12 families.

Formerly, W070 was required for operating a Teletype with a PDP-8, 8S, Linc-8, or PDP-9; PDP-8I or 8L have utilized earlier revisions of the W076.

If a chain of grounds is present in the PDP-8 memory wing, the W076 D will be shot circuited and damaged when power is applied.

The following list of deletes will correct this situation. Incorporate this change only if a W076D is to be used.

Deletes:

MF30C - MF30F
MF30F - MF30J
MF30J - MF30L
MF30L - MF30N
MF30N - MF30P
MF30R - MF30U

digital	FIELD SERVICE TECHNICAL MANUAL				Option or Designator
	12 Bit <input checked="" type="checkbox"/>	16 Bit <input checked="" type="checkbox"/>	18 Bit <input checked="" type="checkbox"/>	36 Bit <input type="checkbox"/>	W406

Title USING BW406 MODULE				Tech Tip Number TT#1	
All		Processor Applicability		Author L. Goetz	
8	11	15		Rev g	
				Approval G. Chaisson	
				Date 2/1/74	
				Cross Reference BW406 TT#1	

Reference purposes only.

-- NOTES --

digital	FIELD SERVICE TECHNICAL MANUAL				Option or Designator
	12 Bit <input checked="" type="checkbox"/>	16 Bit <input type="checkbox"/>	18 Bit <input type="checkbox"/>	36 Bit <input type="checkbox"/>	W750

Title					Tech Tip Number	
W750 JUMPERS & REVISIONS					W750-TT-1	
All	Processor Applicability			Author	Rev	Cross Reference
	8			W. Freeman	g	
			Approval	Date		
			W. Cummins	11/15/73		

The W750 Teletype Line Unit module has been modified several times, resulting in revision "B" not being interchangeable within a 689 option in certain applications.

W750 REVISIONS

SCHEMATIC	ETCH	MODIFICATION
Ø	A	-
A	B	Filter modified
B	B	R6 removed
C	D	Direct, noninverting, nonfiltering input added

Only etch revision "D" modules are now being sold and modules which come to the factory for repair are not being updated. Therefore, a mixture of various revision W750's will be found to be in the field.

An etch revision "A" or "D" is required when the customer application dictates a noninverting, nonfiltered input to pin H; an etch revision "B" will not operate in that application unless modified with jumper #3 (from diagram on next page) which will effectively alter the board to etch revision "D" level.

W750 JUMPING CONSIDERATIONS IN 689 OPTIONS

The two possible states of a communications line are referred to as "marking" and "spacing". One problem area in the use of these terms is that any two differing voltage levels may be used and customer requirements will determine which voltage levels are to be used and how marking and spacing will be defined in the particular system. EIA Standard RS-232-B defines "marking" as a binary 1, a voltage equal to, or more negative than -3 vdc; "spacing" is defined as a binary 0, a voltage of +3 vdc or greater.

COMPANY CONFIDENTIAL

Title						Tech Tip		
W750 JUMPERS & REVISIONS (cont.)						Number W750-TT-1		
All	Processor Applicability					Author	Rev	Cross Reference
						W. Freeman	0	
						Approval	Date	
						W. Cummins	11/15/73	

The chart below indicates the jumpering necessary to adapt a W750 to specified input and output requirements. It should be noted that the W750 levels do not conform to EIA Standard RS-232-B.

INPUTS

W750 JUMPER	VOLTAGE POLARITY	JUMPER DEFINED	COMMENTS & APPLICATIONS
1	Ground at Pin H	Lug at pin H to lug at junction of R2 (150Ω ohm) and diode D1	Inverted input to "Line Mux Out" (most likely to be used most often)
2	-3 vdc at Pin H	Lug at pin H to lug at R1 (300Ω ohms)	Noninverted, filtered input to "Line Mux Out"
3	-3 vdc at Pin H	Lug at pin H to junction of collector of Q1 and R4 (150Ω ohms) NOTE: Revision "D" boards provide a lug at the Q1/R4 junction	Noninverted, unfiltered input to "Line Mux Out"

OUTPUTS

W750 JUMPER	VOLTAGE POLARITY	JUMPER DEFINED	COMMENTS & APPLICATIONS
4	Ground at Pin U	Lug at pin M to lug at pin N	Noninverted (most likely to be used most often)
5	-3 vdc at Pin U	Lug at pin L to lug at pin N	Inverted

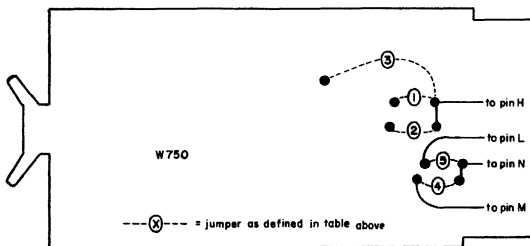

COMPANY CONFIDENTIAL

digital	FIELD SERVICE TECHNICAL MANUAL				Option or Designator
	12 Bit <input checked="" type="checkbox"/>	16 Bit <input type="checkbox"/>	18 Bit <input type="checkbox"/>	36 Bit <input type="checkbox"/>	W968 to XY8E

Title				W968 Collage Mounting Boards		Tech Tip Number		W968 TT-1			
All	Processor Applicability				Author		W.J. Moroney		Rev g		Cross Reference
	8E				Approval		W.E. Cummins		Date 7-31-72		

W968 collage mounting boards are not interchangeable with W967/W966 collage boards. The W967/W966 was designed specifically for the 8E. W967/W966's have their pin DA2 in contact with the 8E 15V bus while W968's use +5 volts on pin DA-2.

Title				PDP-8/E XY8E Plotter		Tech Tip Number		XY8E TT-1			
All	Processor Applicability				Author		Bill Moroney		Rev g		Cross Reference
	8E				Approval		W.E. Cummins		Date 7-31-72		

Sales literature has erroneously called out 25 foot cables as standard with the XY8E plotter. Twenty-five (25) foot cable is a special and must be ordered as such if required. Twelve (12) foot cable is the standard. 8E marketing is taking steps to notify the field of this problem through sales and marketing channels.

Twenty-five (25) foot cable must be twisted pair. The 12 foot cable is straight, 10 conductor standard wire in a round case.

COMPANY CONFIDENTIAL

digital

DIGITAL EQUIPMENT CORPORATION, MAYNARD, MASS. 01754

PRINTED IN U.S.A. 1074 TD94 1006/16 05