

Tekniques

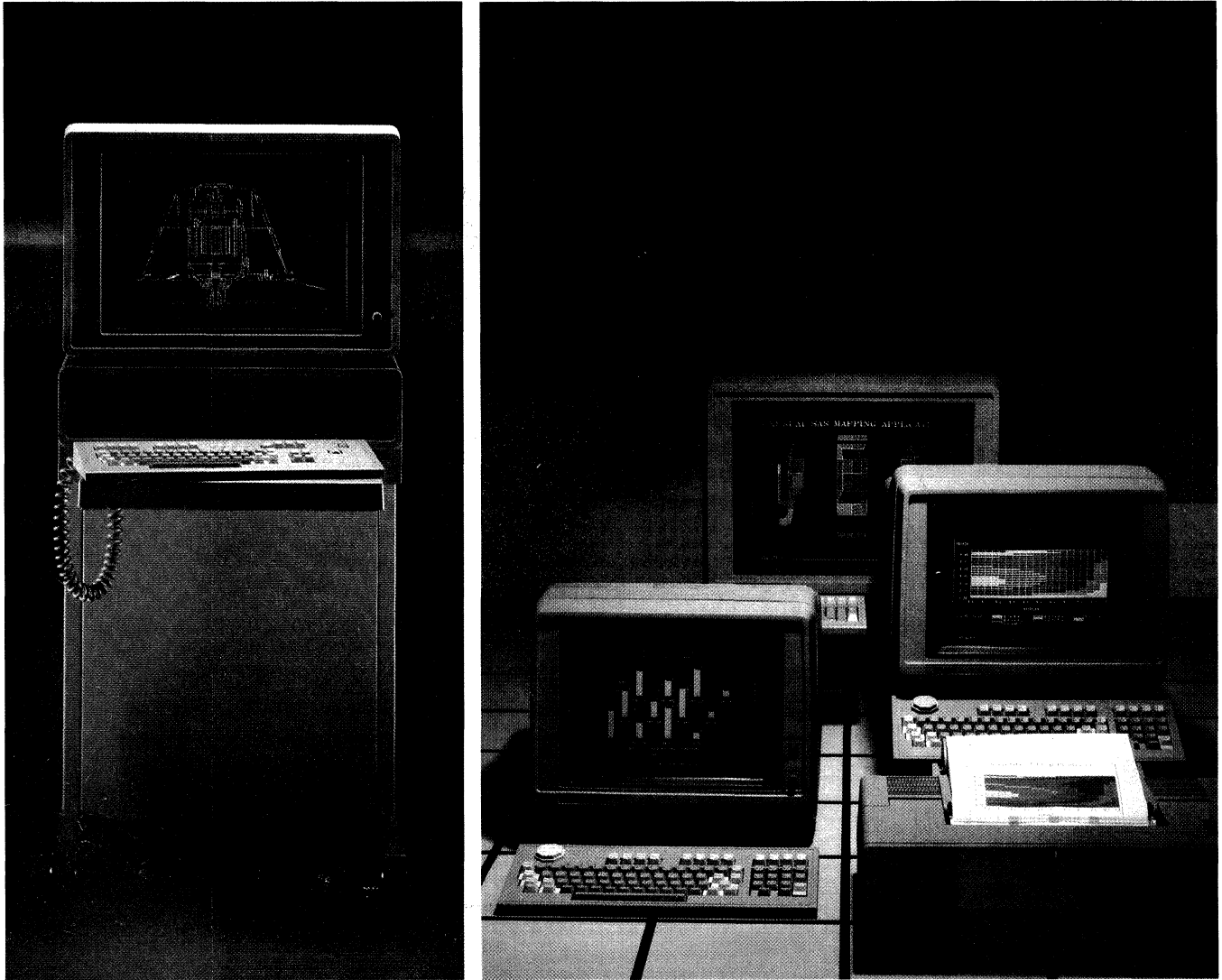

SOLUTIONS

Tektronix[®]
COMMITTED TO EXCELLENCE

Tekniques

In This Issue

PLOT 50 2-D Drafting Cuts Ship Design Time at U.S. Coast Guard Headquarters	2
Tektronix 4050 Series Extended Memory: Working Smarter	5
Graphics Systems Workshops	8
4100 Family Widens Tektronix Graphics Spectrum	9
Low-Cost Color Copier Captures 4100 Screen Images	14
PLOT 10 Software Products in Full Color	15
Local Programmability Extended to Tektronix Low-Cost Terminals	16
Editor's Note	17
4907 ROM Part Number Correction..	17
Tektronix 4115B Computer Display Terminal: Tailored for Demanding Graphics	18
Tektronix Disk Subsystems: Compact and Capable.....	21
4050 Series Interfaces to 4695 Low-Cost Color Graphics Copier	22
Mechanical Engineering/Integrated Circuit Design Aided by Software....	23
Programming Tips.....	25
TEKniques Update Card	27
Tektronix Computer Graphics Supplies.....	29
Program Exchange	30
Library Addresses	31

TEKniques, the IDD Applications Newsletter, is published in the Information Display Division of Tektronix, Inc., Mail Stop 63-575, P.O. Box 1000, Wilsonville, Oregon 97070. It is distributed to TEKTRONIX computer and terminal users.

Publishing Manager	Ken Cramer
Managing Editor	Patricia Kelley
Technical Editor	Dan Taylor
Graphic Design	John Ellis
Circulation	Rory Mutton
Typesetting	Jean Bunker

Copyright © 1983, Tektronix, Inc.
All rights reserved.

To submit articles to *TEKniques* or for information on reprinting articles, write to the above address. Changes of address should be sent to the IDD Program Exchange serving your area (see Program Exchange addresses).

On the cover: Compatibility and quality are key ingredients in the design of the new Tektronix Computer Display Terminals. The 4105, 4107 and 4109 occupy the entry level of the Tektronix graphics terminals line; the 4115B fills out the high end.

PLOT 50 2-D Drafting Cuts Ship Design Time at U.S. Coast Guard Headquarters

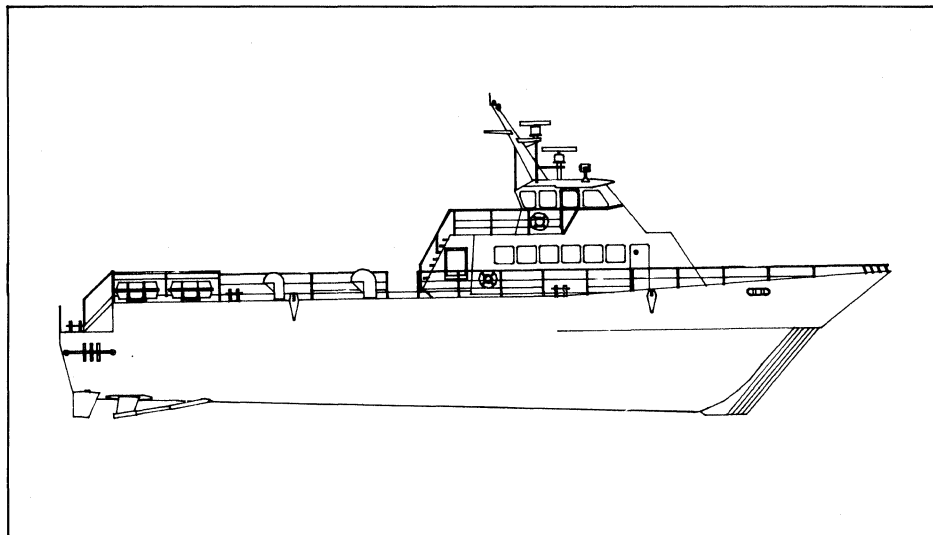

At U.S. Coast Guard Headquarters, naval architects employ the Tektronix 4054 Desktop Computer and PLOT 50 2-D Drafting to design the interior facilities of U.S. Coast Guard ships. (Photo and plots courtesy of U.S. Coast Guard.)

by Patricia Kelley
TEKniques Staff

At U.S. Coast Guard Headquarters in Washington, D.C., the Design Branch of the Naval Engineering Division is charged with designing new ships and the overhaul of existing ships. Each project can run between \$30 and \$60 million and can take up to a year in the conceptual phase and up to five years from beginning to actual ship delivery.

The designers must meticulously integrate a complex assortment of components, systems and subsystems into a well conceived ship, a ship able to survive extreme wind and sea conditions through the years while providing livable accommodations for her crew. Streamlining the design process is vital to meet the goals of performance, budget and schedule.

Naval architects within the Concepts and Arrangements Section have incorporated Tektronix PLOT 50 2-D Drafting systems into their work. By automating the layout of the ship's interior facilities, Dan Bagnell, Section Chief, estimated that the work previously accomplished by manual methods of sketching and paper cut-outs is being done in roughly one-fourth to one-third the time.

The ships range in size from 30 to 55 feet wide and 100 to 400 feet long. Bagnell's Sec-

tion assumes responsibility from idea to the ship's completion. For a complex design, the conceptual design process can last a year and within this time the design is in a constant state of change. Using PLOT 50 2-D Drafting, the Section is able to rapidly update the interior arrangements. At the end of the conceptual phase, final facilities layout drawings are plotted on the large CalComp plotter and incorporated into the bid packages.

Interior Facilities Arrangement

Beginning with meetings between Bagnell's staff and the Coast Guard officers who will operate the ship, specifications are outlined - the type of ship, its length and breadth, number of crew members - and budget constraints set. With this basic information, the Concepts and Arrangements Section begins their task.

Bing Fuller, naval architect, uses the Tektronix 4054 Graphics System and a host computer to define the ship's outer surface. Once these outer boundaries are established, Sid Thomas, naval architect, conceptualizes the ship's interior facilities. He works closely with the Structures Section which determines the location of main structural members such as load bearing, bulkheads (walls), stanchions, foundations and so on.

With the exception of the machinery and electrical areas, Thomas arranges the interior of the entire ship. Although he allocates space and is involved in the aesthetics of the machinery and electrical areas, the layout of these facilities is done by two other Sections.

Out of approximately 27 drawings for the conceptual phase of each ship, the interior arrangement drawings number approximately eight and all are created and revised with PLOT 50 2-D Drafting. The outboard profile drawing depicts the exterior view of the ship sitting in the water. An inboard profile slices longitudinally through the center of the ship identifying all levels of the ship and the various compartments. Deck arrangement drawings consist of one illustrating the third deck and below, and a main deck and second-deck drawing. Three level drawings, 01 level, 02 level and 03 level, depict the layout of the superstructure levels above the main deck. A final drawing shows the outline of the entire ship at various levels. It contains a legend of materials and their location within the ship.

Layout of the interior facilities of a ship is an iterative process with common components. Fuller commented that the prime reason for selecting PLOT 50 2-D Drafting was its symbol capability. They knew it could save them immense amounts of time in their repetitive drawing operations. They have not been disappointed.

Taken from both Navy and Coast Guard drawings, the symbol libraries Thomas has developed contain all the typical symbols used in this type of application. These libraries have enabled him to conceive, test and verify arrangements more rapidly and with greater accuracy. For instance, the outboard profile drawing averaged 2 to 3 days or 16 to 24 hours using manual methods. With PLOT 50 2-D Drafting generating this drawing, it took approximately 4 to 5 hours.

Being able to respond more quickly to changes and develop new drawings has allowed the Section to explore more layout options. Recently, after creating the initial design for a major proposal, Thomas deliberated with one of the program managers and decided to try an alternative plan. "In a matter of a day or so I put together another option. This would have been impossible to do manually in that period of time," he reflected.

PLOT 50 2-D Drafting has tremendously increased their work capabilities according to Fuller and Thomas. Previously they had to delay new projects, since they didn't have the manpower nor time to do them. At the present they have three or four major designs under way. This compares to 100% to 150% more work they are able to handle with

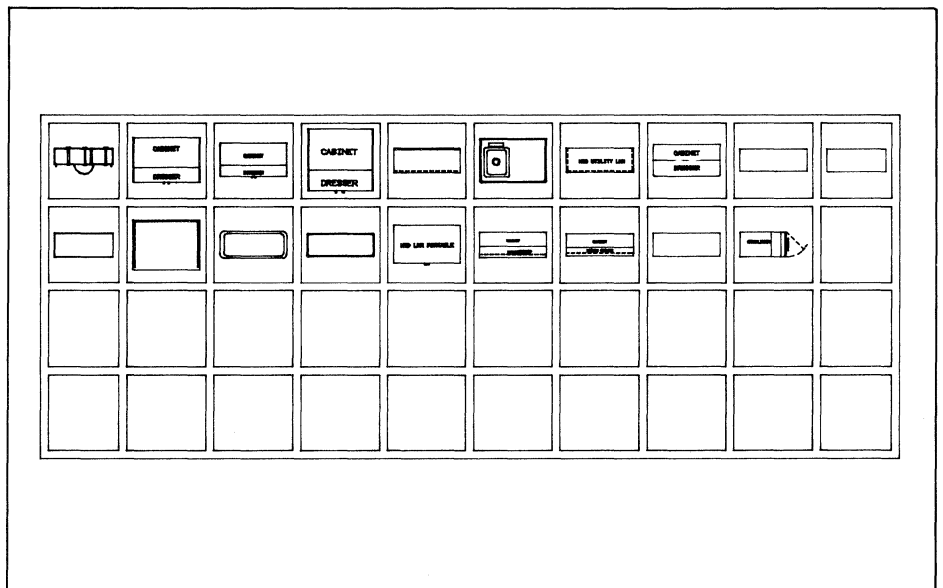
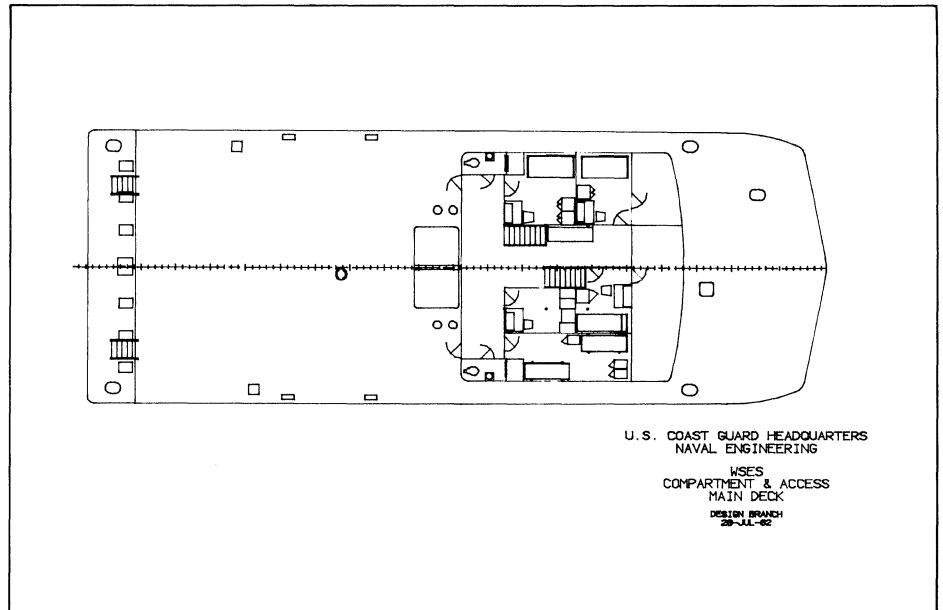
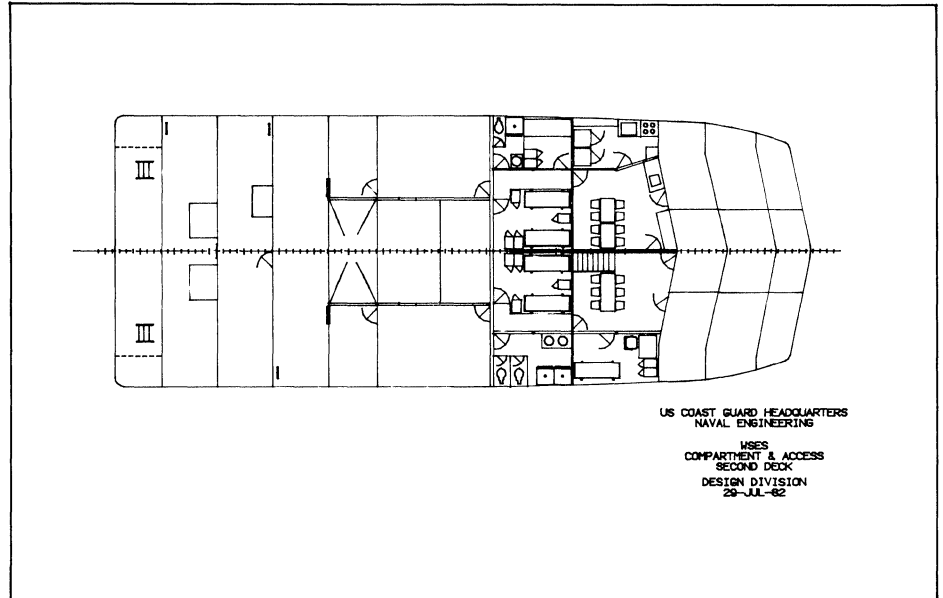

PLOT 50 2-D Drafting over the manual methods. The use of 2-D drafting has enabled the USCG to work on various design projects that would otherwise have been delayed or not worked on at all.

Using the System

Thomas related his introduction to PLOT 2-D Drafting. "I just sort of taught myself. I had the one day overview and then started playing with the system. In a matter of a week and a half I was productive. And, of course, my productivity has increased."

Fuller and Thomas both like the tablet menu of drafting functions rather than having to learn a command language or deal with a hierarchy of menus on the screen. The delta function has provided Thomas with a particularly useful method of input. Considering the size of the typical ship, it is impractical to work with the entire drawing on the screen. Thus, he scales the ship so its width fits within the height of the 4054 display and windows in on the ship lengthwise. At this large scale it would be impossible to pinpoint the exact location of an end point using just the cursor on the screen. By specifying the change in X and change in Y coordinates from the last position, however, the drawing is absolutely accurate. "I can zoom in, down to the bolt-hole level if I wish, and the drawing is better than even the best draftsman could do," said Thomas. The recently-added smooth line (spline) option to PLOT 50 2-D Drafting has also been very useful. This option enabled the users to draw ellipses and to draw faired lines to match the curvature of the ships hull. A prime example of this function usage is elliptical basins for lavatory counter tops in the sanitary spaces.

More Streamlining Ahead

What the Concepts and Arrangements Section has accomplished with PLOT 50 2-D Drafting is just a start. Fuller defines the entire outer surface of the ship in one large mathematical equation using a host computer. He plans to modify the program so it will create a file in GMX picture format. PLOT 50 2-D Drafting can then access the picture file and produce his drawings.

The USCG is also working on converting a B-spline technique for defining ship hulls to run on the Tektronix 4054 Graphics System. Fuller is excited about the possibilities. By incorporating a Tektronix 4909 hard disk into their systems, he feels he can put his Line Drawing into PLOT 50 2-D Drafting. This would provide not only Thomas with the data base for the surface definition, but also the other Sections - Structures, Machinery, Electrical. Since Fuller and Thomas keep the two systems working continually, they would

like to see another added for the other Sections. By sharing the 4909 and the data base, the design process can be further streamlined.

Naval architects, Thomas and Fuller both have many years' experience in designing ships. Prior to the U.S. Coast Guard, Fuller was with the Navy 21 years working with computers extensively in computer-aided ship design. Thomas' first experience with computers was the 4054 and PLOT 50 2-D Drafting. He had been firmly convinced that he wouldn't ever use computers in his work but has changed his mind. Both agree the PLOT 50 2-D Drafting has provided them with the proper tools without encumbering them. It leaves the decision to the designer but solves the tedious manual tasks.

Although both systems were easily installed without problems, all three men cited the willingness of Connie Coleman and Jack Bergan of Tektronix's Rockville office to assist them. Fuller and Thomas have just recently completed the PLOT 50 2-D Drafting Workshop and rate it very high also. They both commented that even though they had worked with the system for several months and knew a great deal about it, the workshop has given them bits and pieces here and there which make it easier and quicker to do their job.

Editor's Note: *TEKniques* thanks Dan Bagnell for his time on the telephone and Fuller and Thomas for taking time from the PLOT 50 2-D Drafting Workshop to relate their feelings about the system. A note of thanks also to Jack Bergan and Bob Padison for introducing us to these enthusiastic users.

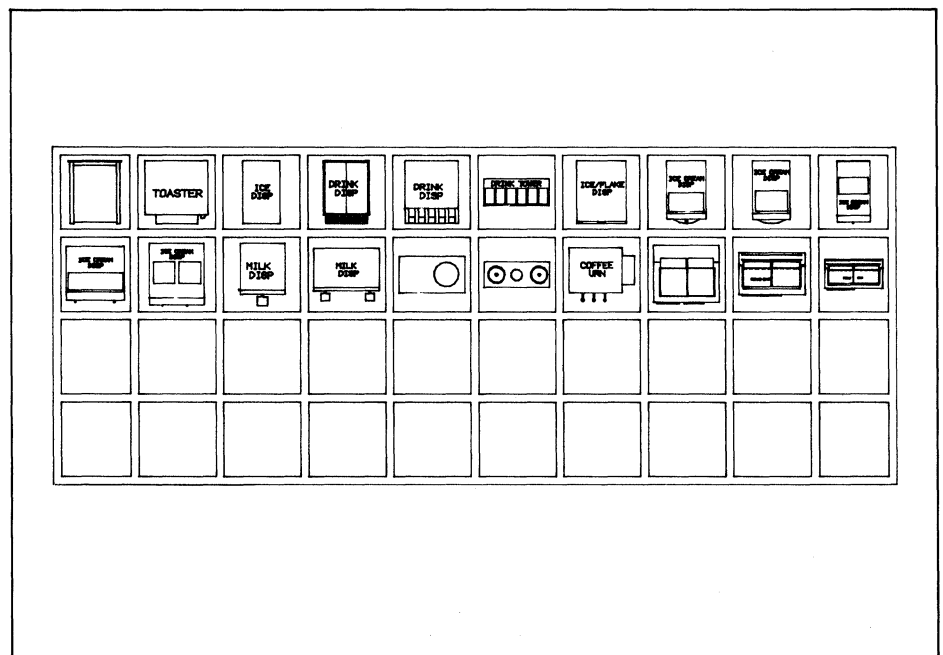
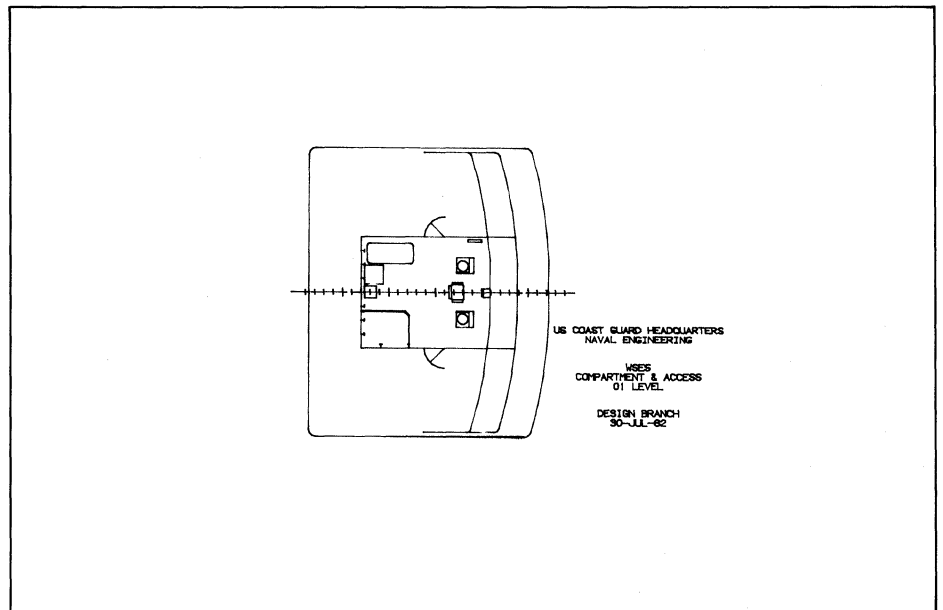

Tektronix 4050 Series Extended Memory: Working Smarter

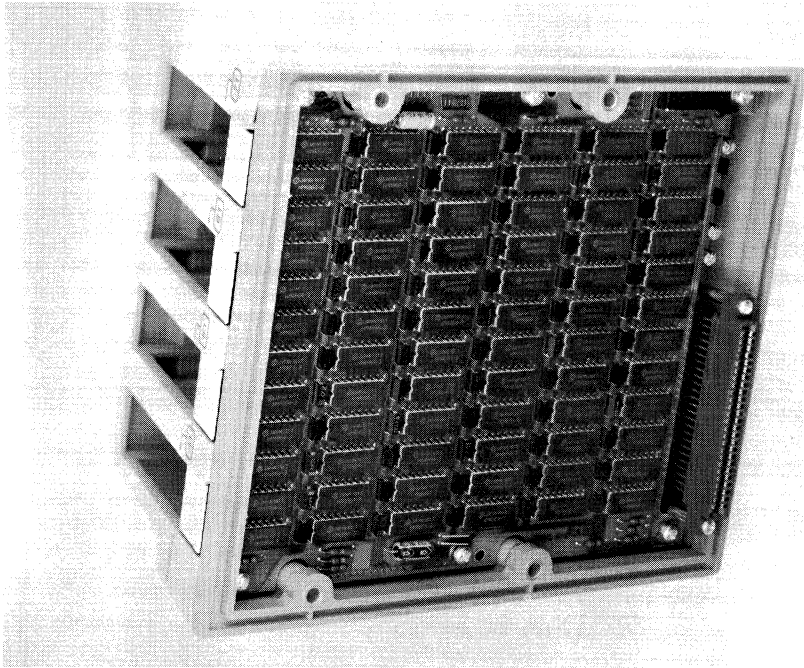

Unobtrusive packaging of the Tektronix Extended Memory File Manager within the 4052/4054 ROM Pack Expander unit was just one of the benefits of thoughtful engineering when satisfying the need for more user memory on the 4052/4054 Desktop Computers.

by **Brian Diehm**
Tektronix, Inc.
Wilsonville, OR

TEKniques Vol. 6, No. 3 reviewed the benefits of the recently introduced Extended Memory File Manager. A glimpse beneath its surface and behind the scenes explains its success.

Rather than implementing a virtual memory scheme, Tektronix chose to provide additional memory to 4052/4054 Desktop Computer users through a simulated flexible disk interface. In doing so, Tektronix satisfied user needs without burdening them with the expense of a long development cycle and the risk attendant with the "technologically advanced" solution (see sidebar - "An Engineering Approach"). This "electronic disk" also provided users with a unique method for handling overlays and data files.

A Disk in Disguise

The electronic disk, packaged within the optional 4052/4054 ROM pack expander unit, has no switches or indicators, nor does it take up any of the ROM pack slots in the expander. Its unobtrusiveness fits neatly with its nature of being a strictly internal high speed device. The programmer is aware of the de-

vice only by programming it; the ultimate application user needn't be aware of it at all.

To retain the contents of the electronic disk when the 4050 is powered off, power to memory is provided through a small separate unswitched power supply. A battery backup ensures data retention through power failures and while the 4050 is unplugged for short periods, e.g., moving it from location to location. The power supply with its battery backup is placed under the keyboard of the 4050 System, out of sight.

The electronic disk has its own ROM pack which is built into it. This guarantees that the ROM pack will always be plugged in, and plugged into a specific slot in the bank of available slots. This particular electrical location is important for the operating scheme of the electronic disk.

As each 4050 ROM pack is powered up, the functions it supports and addresses for these functions are saved in a table in 4050 memory. Later, when BASIC needs a function supported in a ROM pack, it scans the power-up tables in the same order as they were powered up until that function is found.

The placement of the electronic disk ROM pack ensures that it is powered up last; thus,

when a flexible disk ROM pack is present, it will already have been powered up and its entries made in memory. On power up, the electronic disk scans these tables for flexible disk ROM pack entries. If found, the electronic disk "trades places" with the flexible disk. When BASIC scans these ROM pack tables, it finds the disk calls in the electronic disk table before the flexible disk entries. Thus, the electronic disk "intercepts" all disk commands and passes on only those not targeted for itself. Intercepting all disk commands does add some time to those commands ultimately targeted for the flexible disk, but the speed of the electronic disk makes the overhead negligible.

A Compatible Link

As a convenient interface for 4052/4054 users, the electronic disk behaves like the existing 4907 File Manager. While in theory an electronic disk is a solid state implementation of a hard or flexible disk, the physical differences of the two result in different usage patterns. Consequently, most of the functions in the electronic disk exactly match their counterparts in the 4907, but the 4907 flexible disk has some capabilities that are inappropriate for the electronic disk. Therefore, the electronic disk accepts all 4907 commands and ignores those which are superfluous.

Because it is nonremovable, the electronic disk performs an automatic mount function at power up, and if the medium is not formatted, automatically formats it as well. In fact, the first time the user powers up the electronic disk by turning on the 4050 system, a short (2 to 5 second) delay for formatting may be noticed, a delay that will not be present at the next power up. Because the electronic disk is always "mounted," both mount and dismount commands aren't necessary but will be accepted and ignored. Of course, a user may expressly format the electronic disk.

Although the electronic disk doesn't compress files in place (restructure and compact the data on the disk), it still accepts the compress command.

Like the 4907 flexible disk, files on the electronic disk may be named with up to 10 alphanumeric characters followed by an optional extension of up to four alphanumeric characters. Unlike the flexible disk, library levels and passwords weren't seen as adding any real utility to a local dedicated device.

The 4050 Series Electronic Disk An Engineering Approach

When confronted with a design challenge, engineers often think in terms of technological solutions and "greater horsepower." The intuitive approach is to apply the latest technology - faster more powerful chips, exotic algorithms - perhaps bypassing an easily applied method that solves the problem by working smarter, and yet uses available technology. An example of a design challenge was extended memory for the Tektronix 4050 Series Desktop Computers.

The problem was lack of user memory space. The 4050 Series Desktop Computer had reached the 64K memory address limit. Since it featured a BASIC interpreter, any scheme for more memory had to comply with the *modus operandi* of BASIC programmers; the user interface was critical. In addition, adding more memory was being done in conjunction with other major updates to the product which meant very definite time limits for a solution.

The engineering team identified several approaches and fleshed out the characteristics of each:

- 1) A virtual memory approach (bank-switching the address space) provided a transparent user interface, but updating the BASIC interpreter would take extensive effort and might not be completed within the time limits.
- 2) A monolithic array of characters provided a gigantic string for storing alphanumeric strings and numeric values.

While the engineering effort would be trivial, it placed an unacceptable interface burden on the user.

- 3) An internal magnetic tape look-alike matched the integral tape drive of the system, and was familiar to the user. Although faster (no tape seek time), its functionality was limited by sequential-only access and other tape-related restrictions. It would, however, be easy and quick to implement.
- 4) A Pascal-like heap provided additions to the BASIC language to support structured data types, and an area in which the user would define and store them. This method would be fairly low risk except in defining the BASIC interface.
- 5) A nonremovable disk provided the user with a device whose operation was nearly identical to the existing flexible disk peripheral to the 4050 Series, the Tektronix 4907 File Manager. Since the nonremovable disk was internal, however, the absence of seek and head loading time would make it faster. There would be some inherent schedule risk and some forced overhead upon the user for memory management.

Looking at all the alternatives, management and engineering settled on the electronic disk. It was the best suited to overlay management, an important consideration, for no matter how much direct memory is provided, at some point a large program needs to be divided into overlays. The user interface of the electronic

disk would be familiar to users of the 4907 File Manager, and for users not familiar with the 4907, the interface had been proven to be easily learned. If the scheduling became unacceptable, the internal magnetic tape look-alike could be substituted.

It is important to note that the realization of the ideal user interface did not occur until after all the alternatives were considered. Without the engineering investigation, the intuitive assumption of the appropriateness of the bank switching virtual memory scheme would never have been questioned. The result would have been a late product, one more costly, and most important, one less suited for the users' needs.

The electronic disk satisfies the original need for more memory that led to its inception, and goes beyond. But the engineering effort succeeded not because of the application of the latest and greatest in technology. In fact, it uses only tried and tested methods. Its success lies in accurately stating and defining the need to be fulfilled and thoroughly investigating all alternatives instead of leaping to the intuitive approach. The result is a product carefully aligned with user needs, not engineering preconceptions. Like the product itself, that's an example of working smarter! 

Therefore, while the electronic disk firmware will accept complete filename specifications appropriate to the flexible disk, all but the filename and extension are ignored.

The electronic disk assigns different meanings to the values returned from hard error status calls. And when calls to set time and return time are passed to the flexible disk, if no flexible disk is on the system, set time is a no-op and time returns a null string.

A tricky command to implement was the status command CUSTAT which returns the status of all disk controllers on the system. The electronic disk first passes control to the flexible disk, if present, then intercepts the

data string returned to add information about itself.

Several commands are unique to the electronic disk. One is TESTEM which performs either destructive or nondestructive tests of the random access memory of the electronic disk. Primarily a service tool, TESTEM often can pinpoint failures to the individual integrated circuit. Other calls also assist service personnel and include means for reading, writing, or dumping any portion of the memory to the screen.

Strategy in Storage

The electronic disk does not naturally have any "blocking" or partitioning. But it would

be difficult to extend files or recover space left by deleted or shortened files without blocking; therefore, some method of logically structuring the monolithic block of memory is necessary. The firmware implementation treats the device as if it were divided into blocks of 256 bytes each (analogous to the sectors of a conventional external disk).

These blocks in no way restrict the operation of the electronic disk. The firmware can read or write a twenty byte structure in the middle of a block without having the artificial need to read or write entire blocks. Similarly, the firmware can read or write contiguous data files (files where the blocks are assigned in sequential order) in a single operation that ig-

nores block boundaries. On the other hand, it can carefully align scatter files (files where the logical sequence of assigned blocks is in no particular physical order) with block boundaries and transfer data accordingly.

Because the electronic disk firmware recognizes the mode of access and efficiently maximizes the disk's unique properties, it is not viewed as critical that a user have control or even be aware of file scattering.

Unlike scatter files on a flexible disk which can incur much overhead, especially if the blocks are widely scattered and force long seeks between blocks, electronic disk scatter files incur overhead but the penalty is not nearly so severe. Space overhead is one penalty and is typically less than one percent, but in rare cases may range as high as 50%. Time overhead is another penalty but only because of the requisite blocking of data; the seek penalty is nonexistent.

However, when adding to or creating a file in the electronic disk, the space allocation routines always search for a contiguous space large enough for the entire file, and make the file contiguous if possible. When a user expands a file through a SPACE command, or by simply writing off the allocated end of the file, if the file is contiguous, every attempt is made to preserve its contiguity. If it can be expanded in place, that is done. If not, but another area is large enough to hold the entire file, the whole file is copied into the new area. Only if contiguity cannot be maintained will a file be scattered.

Users concerned about the penalties being paid for scattering of files can avoid them by not depending upon the feature of dynamic expansion of files. If all files are always created to full length before being written, no use of scatter files will ever be required. Once a file is scattered on the electronic disk, it can't be made contiguous again.

To provide large gains in performance, array storage in the electronic disk departs from the standard of the flexible disk. Flexible disk arrays are placed in binary files element by element, with an item header byte in front of each array element. The electronic disk writes an array as a collection of bytes from system memory, with only one item header in front of the entire array. While this saves minimal data space on the disk, it provides data transfer rates up to ten times faster than if the standard had been maintained and up to 100 times faster than the flexible disk.

The penalty is that such an array must be read into an array of the same size; the user is unable to read only a portion of the array at a time. For those who have come to depend on this unsupported aspect of flexible disk

usage, the electronic disk offers an alternate file type (specified at file creation) that provides for element-by-element storage of arrays.

An Added Benefit

The electronic disk was developed in conjunction with the A-Series of improvements for the 4050 Desktop Computers, and, therefore, was optimized for use with the upgraded systems. A pair of microcode instructions quickly reads data from 4050 system memory and transfers it byte by byte to the electronic disk data register, and back again. This increases the raw transfer rate of bytes to and from the electronic disk by a factor of twenty, and provides about an eightfold speed increase when used with the 4050A Series.

A Variety of Uses

One of the most useful aspects of the electronic disk is overlay management. For a typical performance comparison, consider an overlay that takes 32K of memory and is written in 670 lines of BASIC statements. This overlay takes 19 seconds to load from an ASCII file on the integral tape 4050 tape drive, 8 seconds from a binary file on tape, 6 seconds from a binary file on the flexible disk, and 2.3 seconds from a binary file on the electronic disk. This increases performance almost an order of magnitude, but even more important, it moves performance into the realm of interactivity.

An operator will object to responses of more than a couple of seconds, and in time will learn to restructure his approach to avoid overlays that are major roadblocks. Responses in the two to three second range won't cause any interruption of thought processes. Its overlay management coupled with its memory retention (battery backup) makes the electronic disk a powerful system for highly interactive, but extensive program tasks.

If the electronic disk performance in program and overlay storage is a quantum improvement, the gains in manipulating data files are truly revealing. While the maximum data throughput of the flexible disk is in the 3K byte-per-second range, the electronic disk can, under optimum conditions, move data at 400K bytes per second, and under less than ideal conditions even increase the rate of the flexible disk by an order of magnitude. In some cases this is due to design improvements not available to the flexible disk, such as microcode assistance of a direct data link as opposed to the funneling of all data through a GPIB. In other cases, such as in streamlining data arrays instead of transferring elements one by one, the improvements are due to new approaches. In still other cases, such as ignoring block structuring when transferring data to and from con-

tiguous files, the physical characteristics of the device are recognized and used to yield the most efficient performance.

The utility of this new performance is self-evident. Consider a program that performs a sort upon a large disk file. The speed of the electronic disk makes it feasible to copy the file to it, perform the sort, and transfer the sorted data back to the flexible disk, the entire operation taking much less time than before. Or consider a program which operates upon local data while interacting with the operator - a mailing list is a typical example. With the electronic disk, local 4050 memory is fully available for the program; no portion of the data must be kept locally to increase speed. Further, all the editing can take place in the electronic disk at high speed, and only at the end of the session transfer the data to a permanent storage device. In fact, the electronic disk could even be that permanent storage device. 

Graphics Systems Workshops

4050 Series

Tektronix desktop computers are ideal tools for improving operating effectiveness. Although satisfied with the job the Tektronix graphics system is doing now, the user probably isn't aware of all its capabilities and how they can be used to increase efficiency.

To help the user get the most out of the 4050 Desktop Computer, Tektronix provides workshops combining classroom lecture with extensive supervised laboratory sessions. Each day the students will exercise the problem-solving concepts presented using a complete desktop computing system.

The 1983 Schedule follows:

<u>Gaithersburg, MD</u>	<u>Santa Clara, CA</u>
May 2-May 6	May 2-May 6
May 23-May 27	July 25-July 29
June 27-July 1	Sept. 26-Sept. 30
August 15-August 19	Nov. 14-Nov. 18
Sept. 12-Sept. 16	
Oct. 10-Oct. 14	
Nov. 7-Nov. 11	
Dec. 12-Dec. 16	

PLOT 50 2-D Drafting Workshops

A comprehensive workshop gives PLOT 50 2-D Drafting users a jump on productivity. Taught by Tektronix professionals, the one week workshop equips the students with knowledge and skills usually gained only through months of experience. Instruction in optimum use of the PLOT 50 2-D Drafting system combined with "hands-on" training tailored to the user's environment accelerates the individual's effectiveness.

Course Objectives/Content:

The workshop teaches effective use of PLOT 50 2-D Drafting.

The workshop consists of lectures and laboratories with an emphasis on the development of efficient working habits and a working knowledge of all system functions and

capabilities. Specific topics which will be covered in the workshop are:

- Reviewing and using all functions
- Generation of quality ink drawings
- Digitizing drawings
- Geometric operations (lines, arcs, line smoothing)
- Note generation and editing
- Workset usage
- Blanking
- Drawing modifications
- Drawing organization
- Uses and creation of symbols
- Configuring equipment

The workshop is not intended to *introduce* the student to drafting or the PLOT 50 2-D Drafting System.

Student Profile:

The workshop is designed for a student who has had a minimum of two weeks drafting experience on the PLOT 50 2-D Drafting System. The student does not require computer experience or a computer programming language.

Enrollment in a workshop is limited to ensure each participant receives the maximum benefit. The following workshops will be taking place in the next few months. Classes may also be scheduled at a customer site.

<u>Gaithersburg, MD</u>	<u>Santa Clara, CA</u>
June 20-June 24	May 9-May 13
Oct. 24-Oct. 28	Aug. 23-Aug. 26

PLOT 10 IGL Workshops

An intensive one week workshop will give FORTRAN programmers or project managers a familiarity with PLOT 10 IGL which will speed them on their way in program development. Instruction in the proper use of IGL routines eliminates the need for experimenting, permitting faster, more effective graphics applications design. Effective training results from keeping class size small and focusing on tasks typical of a user's work. The workshop features hands-on use of the entire Tektronix 4110 Series of graphics terminals, and peripherals such as tablets, plotter and copiers.

Several workshops have been scheduled.

<u>Gaithersburg, MD</u>	<u>Santa Clara, CA</u>
July 25-July 29	May 23-May 27
October 3-October 7	June 20-June 24
	Aug. 29-Sept. 2
	Oct. 24-Oct. 28
	Dec. 12-Dec. 16

<u>Boston, MA</u>
May 16-May 21
Dec. 12-Dec. 16

For additional information regarding these workshops, or to register, please contact:

Tektronix, Inc.
ATTN: Customer Training Registrar
Mail Station 63-574
P.O. Box 1000
Wilsonville, OR 97070
(503) 685-3808

4100 Family Widens Tektronix Graphics Spectrum

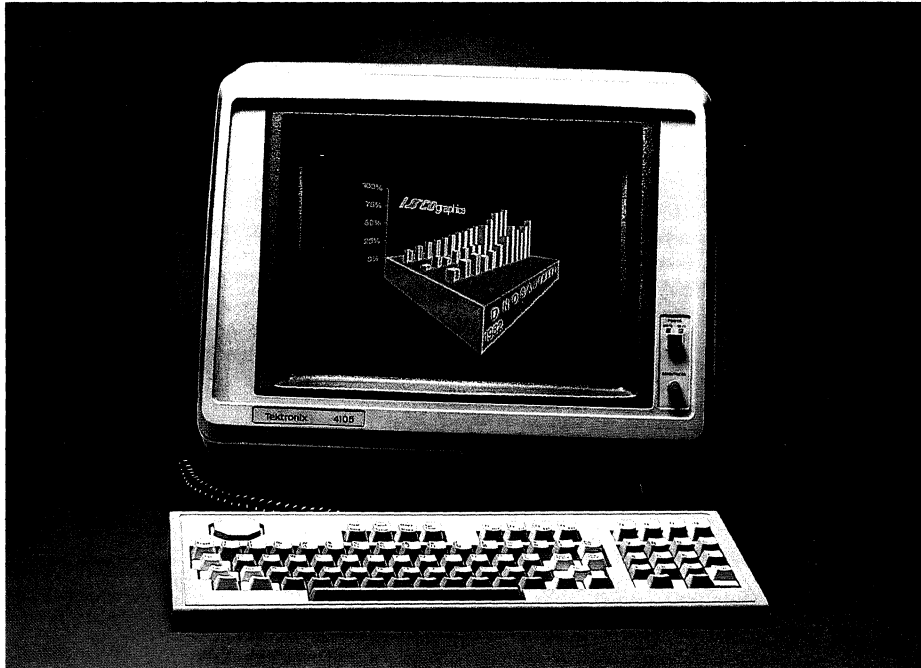

Eight displayable colors on the low-cost Tektronix 4105 Computer Display Terminal enhance business presentations, technical data analysis and CAD previewing.

The early success of Tektronix in the graphics industry can be attributed to a simple formula: offer a low cost, high quality product. The introduction of the Tektronix 4105, 4107 and 4109 color graphics terminals reaffirms that commitment. Occupying the entry level of an extensive and compatible product line, which includes the Tektronix 4110 Series of terminals¹, the 4100 Series offers quality at low prices.

Their performance and reliability, ergonomic design, and low cost make the 4100 graphics terminals the perfect personal tools for engineers, scientists, programmers and others engaged in technical problem solving. Data analysis, presentation graphics, and CAD previewing applications benefit from the fast graphics processing and sharp, bright colors of the 4100 Series. An independent dialog area, ANSI X3.64 compatibility and speedy data communications are important for computer programming and text editing. Unsurpassed reliability minimizes down time.

When incorporated into an environment of existing Tektronix graphics terminals, compatibility with the 4010 and 4110 Series en-

sures that work can easily be transferred from the 4105, 4107 or 4109 to other 4010 and 4110 terminals.

Compatibility also means that 4100 users will not be faced with a massive software development effort. Because the 4100 family supports PLOT 10 protocol², software programs written for 4010 and 4110 Series terminals support the new terminals. This encompasses most of the technical graphics software available today.

Designed for Humans

The 4100 terminals have been engineered to maximize user comfort and convenience. A 60 Hz noninterlaced raster-scan display eliminates flicker and resulting eye fatigue commonly encountered in 30 Hz interlaced displays. The fast refresh rate results in bright colors and a stable image. The dark body glass and etched faceplate of the cathode ray tube (CRT) absorbs ambient light and maintains an excellent contrast ratio at all times. Its short persistence phosphor eliminates smearing when objects are moved or characters scrolled.

The display is tilted upward at a 15° angle for viewing comfort. A Tilt-Swivel-Elevate Glide option (see accompanying photo) allows the operator to adjust the display module to any desired position by tilting it up or down, raising it at or near eye level (which frees space under the display unit for other uses), swiveling it right or left, and moving it forward or backward.

A low-profile detached keyboard affords flexibility. Its 86 keys include four special function keys, eight function keys, and a 14-key numeric keypad. All but four of the keys are programmable using the terminal's macro-definition command. An innovative graphics input device called a "joy disk" is built into the keyboard which is also programmable.

Alphanumeric Strength

The 4100's dialog area permits the operator to interact with the host for menu selection, program editing, and other alphanumeric tasks without interfering with on-screen graphics. The dialog area, which extends the full screen width and is definable from two lines at the bottom to full screen height, appears in front of the screen graphics. Assigned an opaque background the dialog area blocks out the graphics. A transparent background allows simultaneous viewing of both graphics and alphanumeric. Or it may be turned off. The dialog area can be copied independently of the graphics area. Up to eight colors may be chosen for display in the dialog area.

Specially tailored for alphanumeric applications, the dialog area supports upper- and

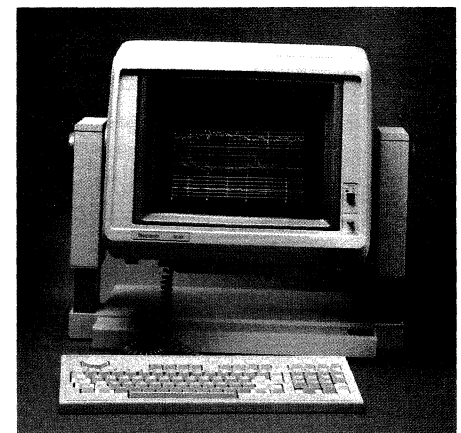

Mounted on a display stand, the 4105 or 4107 Computer Display Terminal quickly adjusts to meet individual comfort requirements.

¹TEKniques Vol. 6 No. 3 and Vol. 6 No. 4 reviewed the 4010 terminals and discussed the 4110 terminals in depth.

²TEKTRONIX PLOT 10 software was covered in TEKniques Vol. 7 No. 1.

lower-case characters with definable attributes that include foreground color, background color, underline, bold, slow-blink and reverse image. All dialog text is stored in scrollable memory for quick reference by simply pressing the built-in joy disk on the keyboard.

The alphanumeric command set complies fully with ANSI X3.64 standards for screen editors and is specifically designed to work with EDT, TV, VI and EMACS full screen editors. Most VT-100 alphanumeric application programs can run without modification on the 4100 terminals.

Graphics Force

The 4100 terminals have powerful graphics capabilities to complement the alphanumeric functions. They retain the 4096×4096 coordinate space of the Tektronix 4010 and 4110 terminals which permits a map, circuit board, or other complex drawing to be defined at a high level of detail in one large picture space. The user simply "windows in" on the defined picture space to expand the viewed area and reveal the detail.

Color is critical for emphasizing, organizing or locating information in a drawing or graph and the 4105 and 4107 terminals provide a palette of 64 from which to choose; the 4109 provides a palette of 4096. For graphics display, the 4105 user may select eight colors while the 4107 and 4109 user may select 16.

Tektronix's consideration for the user is reflected in the user's interface to color. Hue, lightness and saturation buttons on the keyboard permit an inexperienced operator to quickly become comfortable with the selection and specification of colors (see accompanying sidebar).

Eight line styles, 11 marker types and quick polygon fill with solid colors or any of 149 fill patterns, enhance graphs or drawings on the 4100 without taking expensive host processing time. Graphics text can be locally scaled and rotated.

The 4100 terminal's built-in joy disk offers an efficient means for positioning the on-screen cursor. Drawings, symbol and character sets may be precisely digitized on the screen using this eight-directional disk.

Keyboard Intelligence

While the inherent intelligence of all 4100 terminals eliminates high cost host time in alphanumeric handling, color manipulation, quick polygon fill, pre-defined lines and other components of graphics display, it also provides other user features.

English-like commands may be entered from the keyboard to set the 4100 terminal's

Color Standard

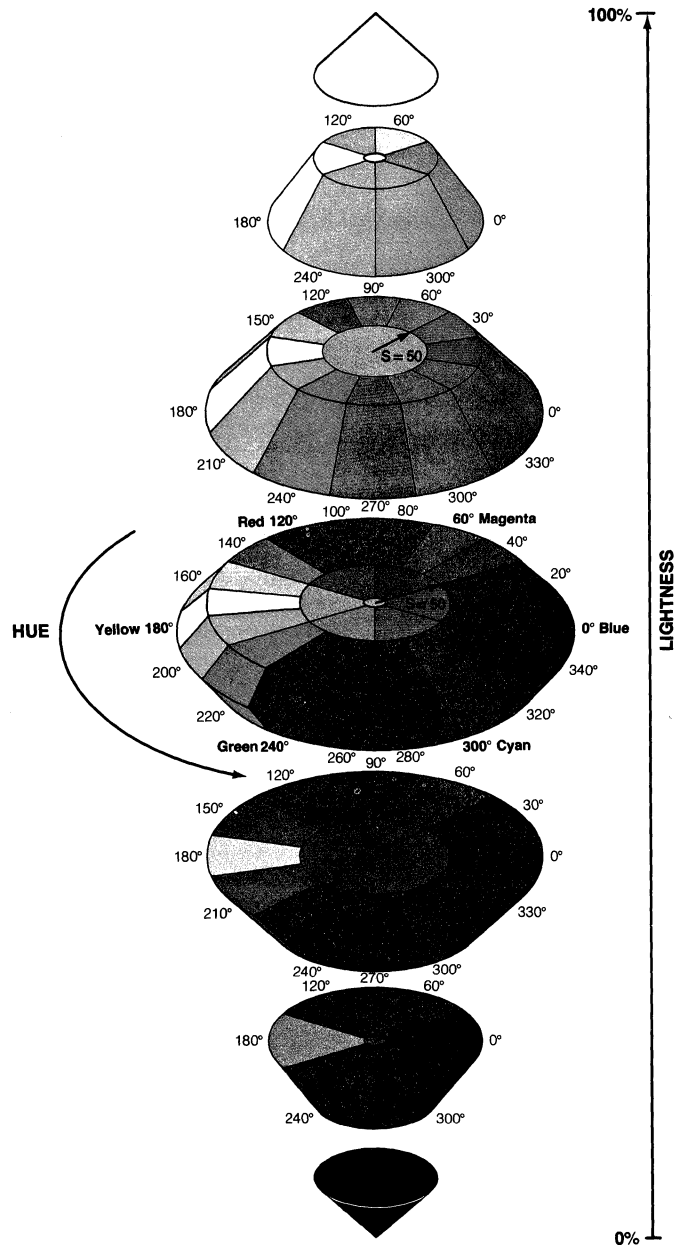

In the **HLS** color coordinate system the color space is represented as a double-ended cone.

The **Hue** coordinate runs counterclockwise around the cone (0 to 360 degrees).

The **Lightness** coordinate runs vertically up the cone (0% to 100%).

The **Saturation** coordinate runs radially outward from the axis of the cone. The **Saturation** coordinate is a percentage of the maximum possible saturation at a particular **Lightness** level (0% to 100%).

NOTE: For clarity, this figure shows the cone divided into only 64 colors, as in the Tektronix 4105 and 4107 terminal. The 4109 terminal has a wider repertory of color mixtures; for the 4109, the HLS cone is divided into 4096 distinct cells, 16 million for the 4115B.

operating environment, to inquire about its status, and to program most of its keys.

Special nonvolatile memory can be used to save operating parameters. At power-up the terminal remembers, eliminating set-up time.

A Family of Strengths

Computer graphics tools can greatly enhance productivity, but too often the cost has been too high or the quality too low to justify their widespread use. The 4105, 4107 and 4109 color graphics terminals complement the 4110 product line at a lower cost but preserve quality and capabilities. Each terminal offers unique strengths for certain applications.

4105 Terminal

Professionals in technical data analysis, business graphics and CAD previewing will find the bright display, rapid data throughput and low cost of the 4105 color graphics terminal create an economical tool with which to enhance their work.

The 480×360 pixel resolution of the 4105 is superior due to its excellent display quality. Because monochrome CRTs are measured differently than color CRTs, the 4105's 13" color CRT actually offers a viewing area only slightly less than a 15" monochrome display and significantly more than a 12" monochrome display.

4107 Terminal

For users whose requirement is a high level of display detail, the 4107 color graphics terminal is more appropriate. Its greater pixel density, 640×480 , in its 13" display permits more detail, smoother diagonal lines, and smaller readable characters. More simultaneously displayed colors in the graphics mode extend the 4100's capabilities.

An extensive command set in the 4107 terminal relieves the host computer of computing tasks and cuts down the communication costs. Because the terminal can store picture segments, perform 2D transforms, and zoom and pan locally, pictures are displayed faster.

The display memory may be used for text instead of segment storage, increasing text storage in the 4107.

Two additional RS-232-C ports support tablets or other RS-232-C devices extending input/output.

The 4107 provides users involved in computer aided design with an economical tool for automating the task. It also serves equally well the technical data analyst who requires finer resolution and more local intelligence.

4109 Terminal

The 4109 color graphics terminal is the big brother of the 4100 family and is targeted to

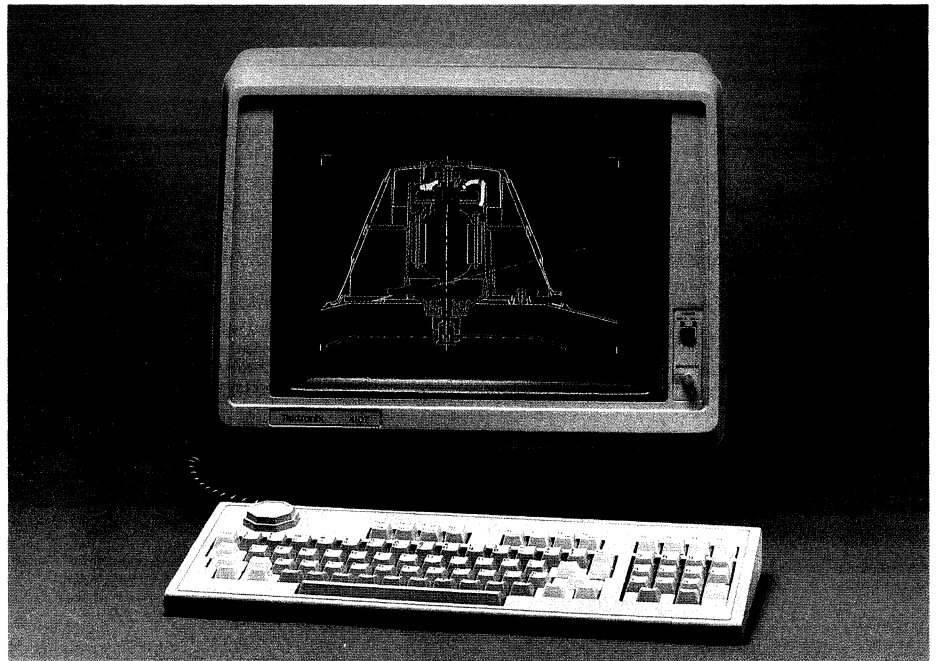

Local pan and zoom, and a special color interface are just a few of the friendly features of the Tektronix 4107 Computer Display Terminal.

address computer aided design applications. Its 19" display provides a larger image for any picture, and physical room on the display to put both menu and graphics information with ease.

Its 640×480 pixel display has the same characteristics of the 4105 and 4107 terminals for a sharp, bright, comfortable picture.

A color palette of 4096 colors supports solid modeling, geometric modeling, stress analysis and other extensive color-oriented applications.

Its Video RGB output gives the 4109 the ability to drive other monitors and interface to RGB devices such as matrix or Dunn cameras.

The 4109, like the 4107, executes segment, zoom, pan, and transformation commands. Tablet support is provided by either of the two supplementary RS-232-C interfaces.

Peripheral Support

In keeping with the 4100 design goal of high quality at a low price, Tektronix will support the 4100 family with a line of low cost peripherals. The first of these devices, the 4695 Color Graphics Copier is easily connected to any 4100 Series terminal. The 4695 uses on-demand ink jet technology to produce eight-color copies of screen information on either paper or transparent sheets. (See the related article in this issue of *TEKniques*.)

The Tektronix 4662 and 4663 Plotters may also be driven from the 4100 terminals through their RS-232-C interface.

Software Support

Over the years Tektronix PLOT 10 ANSI

Standard FORTRAN software has become an industry standard for displaying graphics, and most technical graphics software today is PLOT 10 compatible. Because the 4100 graphics terminals support PLOT 10 protocol, existing programs written for 4010 and 4110 Series terminals, including the Tektronix' PLOT 10 Terminal Control System, PLOT 10 Interactive Graphics Library and PLOT 10 Easy Graphing II packages, may be used with the 4100 terminals.

PLOT 10 packages have been enhanced to take advantage of the 4100 terminals' color abilities. A related article in *TEKniques* describes these enhancements.

Tektronix Solution Vendors, the SAS Institute and Integrated Software Systems Co. (ISSCO) have announced 4105, 4107 and 4109 support in their software products - SAS/GRAPH, DISSPLA, and TELLAGRAF.

Locally Programmable

Interactive graphics applications and common functions of text editing, charts and spread sheets may be performed locally without host intervention by configuring the 4100 terminals with the Tektronix 4170 Graphics Processing Unit. A locally programmable processor, the 4170 converts the 4105, 4107 or 4109 color graphics terminals into standalone computers. An accompanying article details the benefits and features of the 4170.

Long Life Expectancy

The simplified, modular design of the 4100 terminals provides reliability and ease of ser-

ving. The 4105, for example, has an estimated Mean Time Between Failure of 10,000 hours, about five years under average use.

A one year on-site warranty is standard with the three new terminals, with an additional two years available for a minimal price.

Any problems that do occur can be quickly isolated to a specific module through the terminal's built-in diagnostics. Easy internal access provides quick servicing.

The terminals are fully supported by Tektronix's worldwide networks of field service centers.

The 4100 family together with its 4010 and 4110 compatible companion terminals, color copiers, plotters, tablets and software offer a spectrum of graphics products for a wide range of needs and budgets. 



The high performance of the Tektronix 4109 Computer Display Terminal rivals that of more costly terminals.

Forget about Service for 3 Full Years

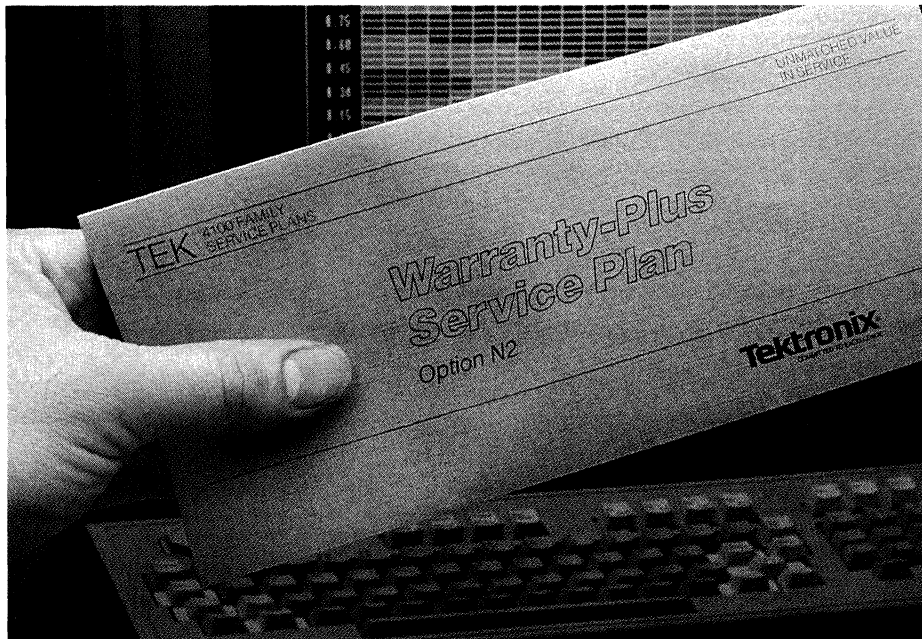

at the time the 4100 terminal is purchased, the 4100 Family *Warranty-Plus Service Plan* provides service in the country where the product and plan were purchased. Travel, parts and labor coverage is identical to the 4100 New Product Warranty.

On-site coverage for both the second and third year costs less than one average service call.

Of course, coverage not offered under *Warranty-Plus* may be obtained through maintenance agreement options. Various response times, weekend or shift availability and extended coverage options are typically available.

A complete statement of the New Product Warranty or the *Warranty-Plus Service Plan* is available from the local Tektronix sales office or service center. 

Every Tektronix 4105, 4107 and 4109 is covered by a New Product On-Site Service Warranty for *one full year*. If a 4100 Family terminal fails to operate properly due to defects in materials or workmanship during the first year of ownership, no charge for labor or parts, including the CRT, will be made to

repair it, restore operation or provide a replacement. Warranty coverage is provided in over 60 countries, regardless of where a product is purchased.

Service coverage in most countries may be extended for two additional years. Available

Coloring from the Keyboard

The 4100 terminal recognizes a color by values of hue, lightness and saturation (HLS), however, the user needn't learn these values to specify colors for the drawing or graph. A special color interface permits the operator to select a color by sight.

Three buttons on the 4100 keyboard control the parameters of hue, lightness and saturation. As the operator presses one of these keys, the terminal displays the new color and simultaneously displays the HLS parameters for the new color. At any time the operator can save that color and exit, restore the original color, or continue with the selection by merely pressing another key.

Three methods are provided for changing colors in a display. Pressing one of the HLS buttons on the display will change the color of the object under the crosshair cursor (and all other objects with a like color index).

Or, the operator may select an object with the crosshairs, call for the color menu, and select one of the colors from the menu for that object and others with the same color index.

The third method changes the color map directly rather than through graphic objects. Graphics are erased and the 4100 displays the colors for all color indexes and their HLS values. An index color can be changed by placing the crosshairs over an index value and pressing individually the three keys controlling the HLS values. 

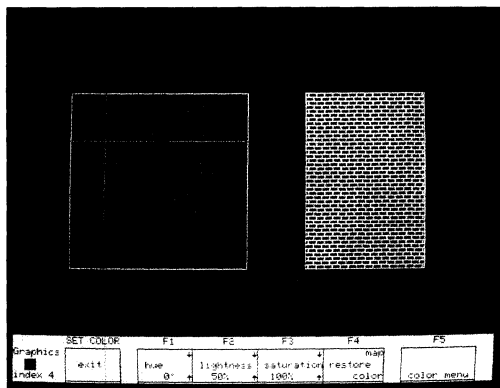

Fig. 1a. When creating a picture or processing alphanumeric on the 4100 screen, a color is not assigned directly to an object; rather, the user assigns each object an index number from zero to seven. Then colors are assigned to the index numbers. In this example, the background of the star has been assigned index 4. To index 4 has been assigned the color with hue of 0°, lightness of 50% and saturation of 100%.

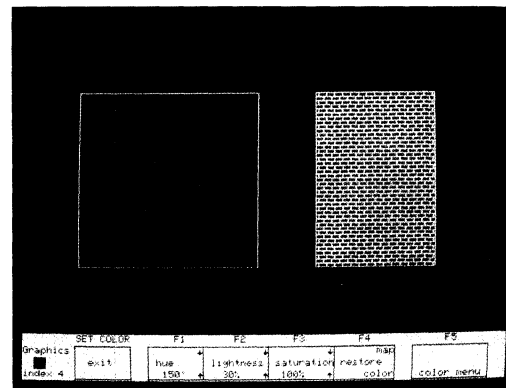

Fig. 1b. Using the color interface, the operator places the crosshairs over the background. Pressing the hue, lightness and saturation keys individually changes the color of the background. At the same time the new HLS values are displayed at the bottom of the screen.

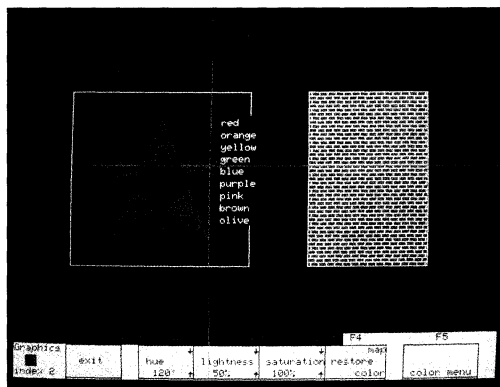

Fig. 2a. To change the color of the star (index 2), the operator first placed the crosshairs over the star, then pressed the color menu key.

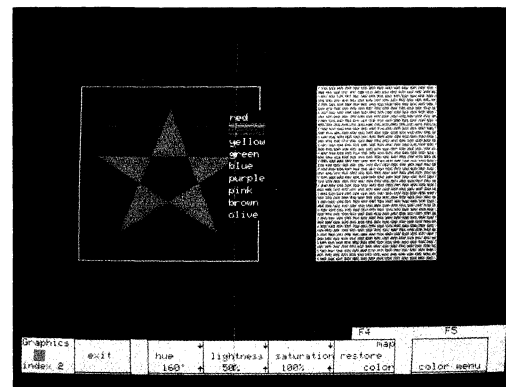

Fig. 2b. As the crosshairs are moved over the menu of colors, the star's color changes accordingly, and the new HLS values are displayed for index 2.

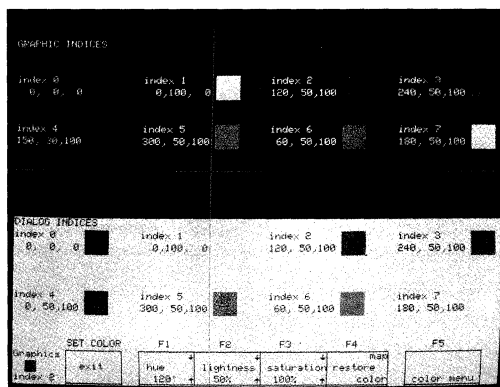
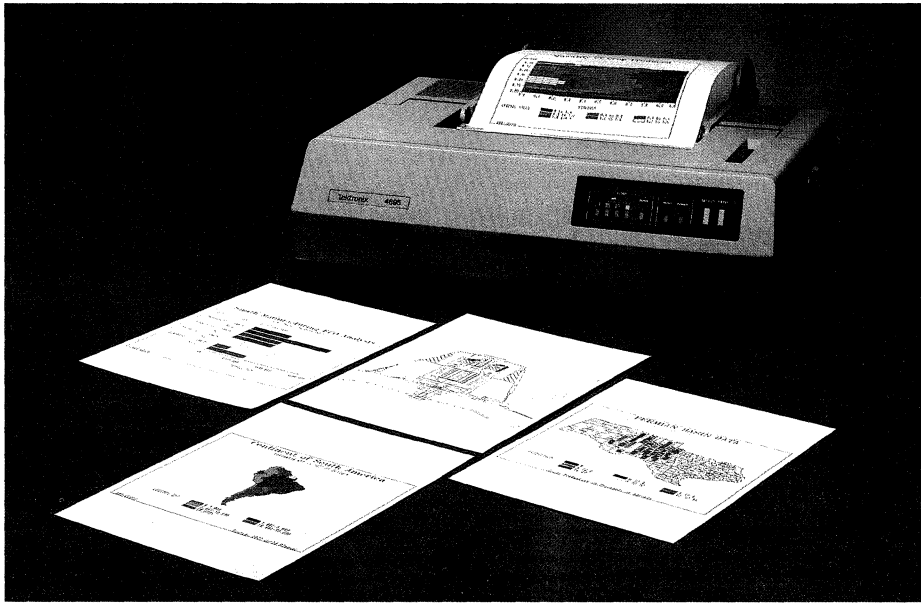

Fig. 3. New colors may be directly assigned to the indexes by accessing the color map.

Low-Cost Color Copier Captures 4100 Screen Images



Quality paper or transparency copies of the image displayed on the 4105, 4107 or 4109 terminal's screen are produced on the 4695 Color Copier.

A companion color copier for the 4100 Series of Tektronix Computer Display Terminals enables graphics information to be conveniently and economically shared. The low-cost Tektronix 4695 Color Graphics Copier quickly reproduces graphs, maps and designs for reports or presentations. Plug-compatible with the 4105 and 4107 terminals, a push of one button translates the screen image into a color copy on the 4695.

Supporting the dialog capabilities of the terminals, the copier also functions as a bi-directional matrix printer. Each character is formed in a 12 x 16 dot matrix.

Copies can be made of the 4100's graphics only, the dialog area only, or both. Copies may be made under host or local program control as well as from the keyboard.

Crisp Images

Its low price, quiet operation, and compact size make the 4695 suitable as a terminal-dedicated resource. Screen images are duplicated with high resolution and bright colors. On-demand ink jet technology enables the 4695 to "draw" up to 120 dots per inch horizontally and vertically. This allows up to 1280 x 960 points per A-size (8 1/2 x 11 inch) image.

Separate ink cartridges supply the colors of yellow, cyan and magenta which can be mixed

to print red, green and blue. Additional shades can be created under program control. A black ink cartridge provides a true, dense black, superior to one obtained from mixed inks. The true black is a decided asset in the 4695's role as a matrix printer, producing sharp, crisp characters.

Ink and paper are carefully matched for optimum color saturation and brilliance. For viewgraphs, a specially formulated clear transparency media affords sharp, no smear color copies.

Friendly Operation

An easily maintained ink supply eliminates waste. Each 3 cc ink cartridge is monitored

by the 4695 Copier. When the ink supply runs low, a front panel light signals the operator. Self-sealing ink cartridges are simply snapped into place. Should ink run low during a copy operation, the 4695 waits while the appropriate cartridge is replaced then completes the copy.

Pre-cut sheets of paper or transparencies are inserted into the copier using a roller similar to a typewriter. Alternatively, paper copies may be obtained from automatically advanced rolls whose transport includes a cutting bar.

Versatile Copies

Copies from the 4105 terminal are in portrait format with an 8" x 6" image area. The 4107 and 4109 terminals produce landscape format copies with an 8" x 10.6" image area.

As a special feature, the 4695 copier can copy from either the graphics area, the dialog area, or both. When the dialog area of the 4100 terminal is invisible, a copy of the screen will reproduce only the graphics area. Once such a copy is initiated, however, the dialog area may be recalled and communication with the host continued during the graphics copy operation.

Alternatively, the dialog area only may be copied. Because both dialog and graphics functions are shifted to the graphics area while the copy is made, work can continue uninterrupted. When both graphics and dialog areas are being copied, communication is halted.

Copy speed depends on the density of the image. At 1024 x 4 dots per second it takes about 2.5 minutes per average graphics im-

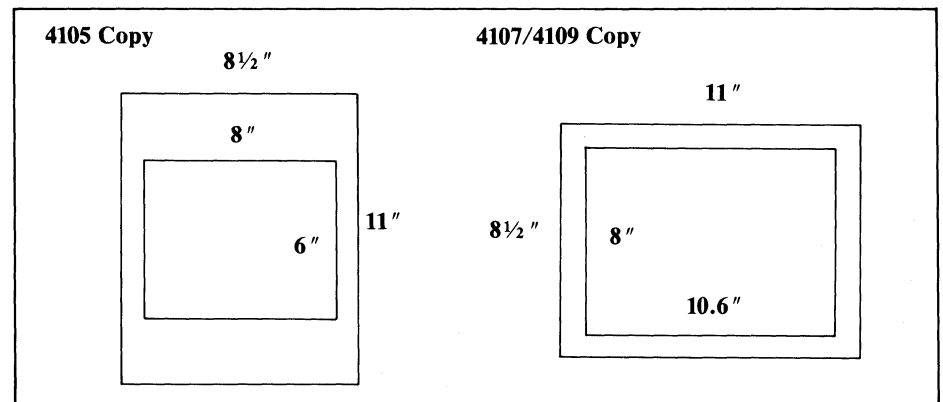



Figure 1. 4695 Image Formats

age on the 4105 and about 5 minutes for the 4107/4109 terminals. As a matrix printer the 4695 copier operates at 20 characters per second.

Reliable Performance

The modular design of the 4695 adds to its reliability and ease of servicing. Mounted on a simple but accurate serial bidirectional printing mechanism, the 16-nozzle (four nozzles per color) print head prints four lines of dots per pass. A nozzle for each color passes over each print location in one pass; multiple passes are unnecessary to mix colors.

Buttons on the rear panel of the 4695 copier initiate self-test and purging procedures to avoid nozzle clogging and assure proper operation.

The low cost and excellent image quality of the 4695 Color Graphics Copier establish it as a perfect companion for a 4100 Computer Display Terminal. And at a compact 24 pounds, the 4695 copier is a perfect match to the space-saving 4105, 4107 and 4109 terminals. 

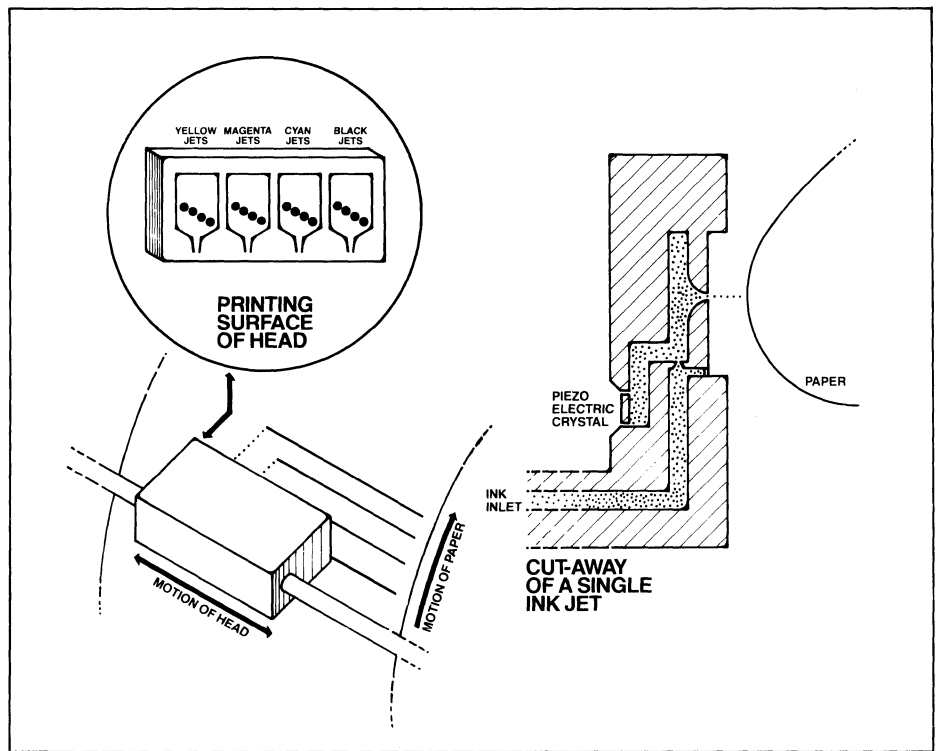
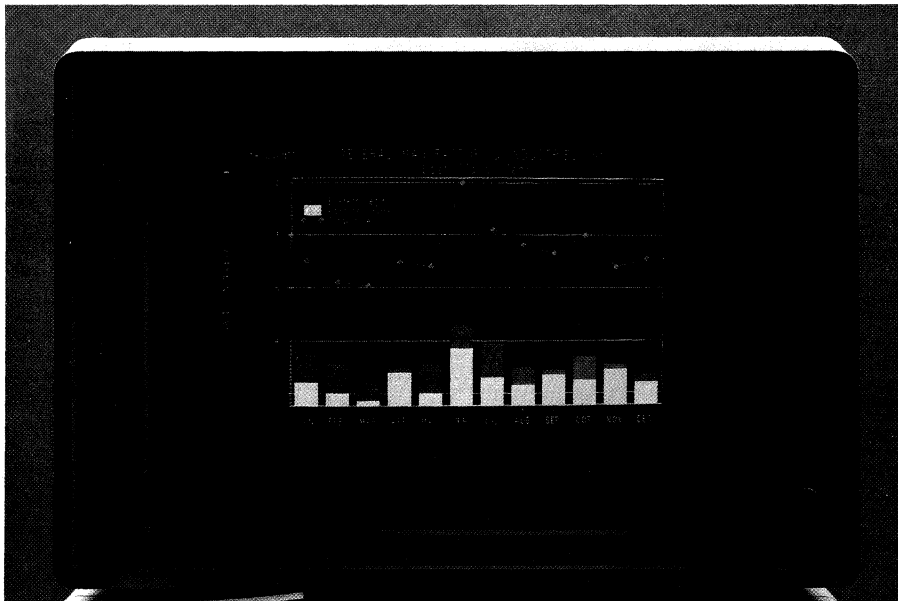

Figure 2. 4695 Drop-On-Demand Head

PLOT 10 Software Products in Full Color



All three of the Tektronix PLOT 10 software product families* will support the new color graphics display products from Tektronix. Color commands for the Tektronix 4105, 4107, 4109 and 4115B Computer Display Terminals will be included in the Terminal Control System (TCS). Device drivers will be added

to the Interactive Graphics Library (IGL) and Easy Graphing II packages.

Existing applications employing TCS may add colored lines, color filled polygons and color patterns through simple FORTRAN calls. PLOT 10 TCS is a compact package of

FORTRAN IV subroutines which the programmer may call to direct the graphics display on the terminal and to aid in formatting alphanumeric output. Designed for minicomputers, TCS is expandable as the need arises, including modules for character and symbol generation, tablet digitizing, plotter routines and others.

Applications developed using the device-independent programming style offered by PLOT 10 IGL will link up and perform in color with the new terminals. Containing all the fundamentals of TCS and more, IGL provides a rich collection of graphics software tools. Stroked character fonts, graphics segments and 3-D graphics are just a few of the features of IGL.

PLOT 10 Easy Graphing II, a full color conversational graphing package, will operate on all Tektronix graphics terminals. A package that nearly anyone can use, Easy Graphing II joins with the new terminals to produce colorful quality graphs at a low cost. 

*The PLOT 10 Family of software packages and their respective capabilities were discussed in *TEKniques* Vol. 7 No. 1.

Local Programmability Extended to Tektronix Low-Cost Terminals

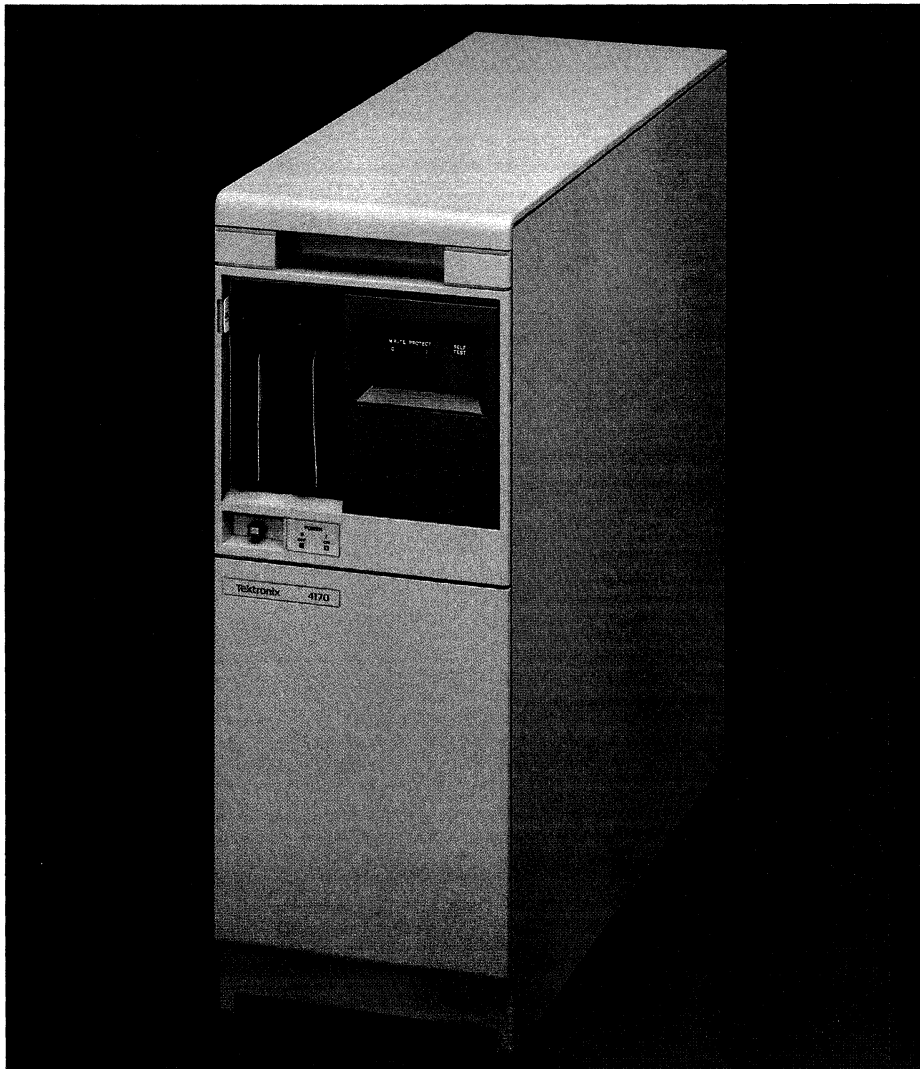

With the Tektronix 4170 Local Graphics Processor, the 4105, 4107 or 4109 terminals can be used in standalone mode.

Infusing intelligence and programmability into a computer terminal permits distribution of the processing load. Portions of applications programs which take place mainly at the terminal – map digitizing, model generation and previewing, data collection and previewing – can be moved from the host to the terminal. Communication costs are cut and line delays eliminated.

The Tektronix 4170 Local Graphics Processing Unit supplies intelligence and local programmability to the new 4100 Series of Computer Display Terminals. A computer housed in a compact cabinet, the 4170 converts any of the Tektronix 4105, 4107, or 4109 terminals into a standalone computer specialized for graphics tasks.

In addition to pre- and post-processing of host data, a 4100/4170 system can execute local applications and perform personal tasks such as text editing, charts, and spread sheets without host intervention.

Programming for Science, Engineering and Graphics

The 4170 Graphics Processing Unit extends 4110A compatible programming capability to the 4105, 4107 and 4109 terminals. Programs developed on a 4100/4170 system can be ex-

**TEKniques Vol. 7 No. 1 carried an in-depth discussion of the components of 4110A Local Programmability, and how they work together. The same methodology applies to 4100 Local Programmability.*

ecuted on 4110 terminals equipped with Local Programmability.*

Using the same Intel 8086 and 8087 co-processors as the 4110A terminals, the 4170 unit provides fast arithmetic calculations for data intensive applications, particularly graphics.

Memory from 256K bytes to 896K bytes facilitates development of large programs reducing the need for overlays. Built-in error correcting code yields greater memory system reliability critical for memory intensive usage such as graphics.

Intel's FORTRAN-86* is an enhanced micro-computer version of this widely used language. An extension of the FORTRAN 77 subset, Intel's compiler supports structured programming, character data type, character functions and other features necessary for engineering and scientific work. The FORTRAN-86 compiler takes full advantage of the 8087 floating point processor and 8086 memory space.

The CP/M-86® operating system provides compatibility with the rest of the 4110 Series terminals. It is also a recognized standard operating system. As in 4110A Local Programmability, Tektronix has enhanced CP/M-86 with utility programs for greater control of system resources.

The Digital Research ASM-86 Assembler comes standard with the 4170 Graphics Processing Unit; Intel's ASM86 Assembler is optional.

Also included in the 4170 package is a Direct Terminal Interface (DTI) Library of FORTRAN-callable subroutines which access the 4100's capabilities with the same LTI commands used by the 4110 Terminals.

A 4100 Local PLOT 10 Interactive Graphics Library (IGL) compatible with the host version of PLOT 10 IGL is also part of the 4170 configuration. Host programs using IGL can be downloaded, compiled and linked to 4100 Local IGL and run locally.

Two language options enable the user to tailor the 4100/4170 system programming language to the application. A BASIC interpreter or Pascal compiler can be installed as well as the FORTRAN-86 compiler. Switching among the languages is simply a matter of inserting the proper disk into the drive and loading it into the 4170. An upcoming issue

of *TEKniques* will delve into language constructs of the 4100/4170 BASIC and Pascal languages.

Software Ready To Go

Software for the 4100/4170 system spans a broad range of sophisticated graphics and non-graphics programs. In addition to Local PLOT 10 IGL software, PLOT 10 Easy Graphing II and PLOT 10 Terminal Control System both execute on the 4100/4170 system. More information on these three packages may be found in a separate article in this issue.

Text editor, spreadsheet, data base management (DBM), charting and project management packages, plus a graphing package system and software development tools are available. Of course, software developed for the industry-standard CP/M-86® operating system will run on the 4100/4170 system with little or no change.

Some of these packages will be covered in future issues of *TEKniques*.

Flexible Configuration

Fitting neatly under a bench or beside a desk rather than cluttering your work surface, the

4170 Graphics Processing Unit requires little space. It is equipped with two 5¼" flexible disks, each providing 320K bytes of formatted storage. A separate dual 5¼" disk drive is available for interchanging data and programs with 4110 locally programmable terminals, or as auxiliary storage. An optional Winchester disk supplies 10MB or 20 MB of storage. (See accompanying article in this issue of *TEKniques* for more information on these two mass storage units.)

Four RS-232-C I/O ports permit flexible interfacing. Interfacing to a 4100 terminal occupies one port. A host port operates in full duplex mode, asynchronous up to 19.2K baud. The two peripheral ports could accommodate RS-232 devices such as the Tektronix 4662 and 4663S Digital Plotters, the 4643 Printer, or a tablet.

A Centronics-compatible parallel interface for a printer or copier may be slipped into one of the three slots available for options. An optional Color Copier Interface provides plug compatibility with the Tektronix high performance 4691 Color Copier.

Another slot may be used to add three more RS-232-C I/O ports. Other combinations are possible.

An Unbeatable Combination

The 4100 color graphics terminal teamed with the 4170 Graphics Processing Unit provides a low cost alternative for the serious user of graphics. The fast processors of the 4170, with floating point operations, quickly convert graphics data into images on the 4100 terminal, displayed in sharp, bright colors. Screen size, aspect ratio, high contrast, low flicker and other performance and reliability features built into the 4100 terminals deliver graphics and alphanumerics of a superior quality.

Multiple input/output ports in the 4170 as well as the terminals support a myriad of graphics peripherals. Tablets, plotters, printers, hard copiers, flexible disk drives and hard disk drives permit the 4100/4170 system user to take full advantage of the power provided by local programmability.

As a workstation in a host environment processing sophisticated graphics locally, or as a standalone personal computer, the 4100/4170 low cost combination is hard to beat. And its compatibility with other family members of the 4110 Series of terminals provides an avenue of growth, protecting investments in software as well as hardware. 

*Editor's Note

It's Time to update *TEKniques*' Mailing List

If you haven't already done so, return the form in this issue to continue your subscription.

Continue Your Subscription

We are in the process of updating *TEKniques*' mailing list. If you didn't complete and return the form in the last issue of *TEKniques*, please take a moment to clip and send along the one in this issue. We welcome any comments, good or bad, you might have about *TEKniques*.

Let's Communicate

Are you using a Tektronix terminal with Local Programmability? If so, do you have a programming tip for others? How about the PLOT 10 users - anything to share regarding IGL, TCS or Easy Graphing II?

Tekniques
Vol. 7 No. 2

Part Number Correction: 4907 ROM Pack

In *TEKniques* Vol. 6 No. 4, the article "New 4907 ROM Pack Enhances and Adds Commands" contained an incorrect part number for the ROM pack. The new ROM pack is orderable by part number 020-0476-01 (not 020-0279-01).

Keep 4050 Series Catalog

The 4050 Series Applications Library catalog published in 1981 should be retained. New pages will be added periodically, but the original portion will not be reproduced. Present holders of the catalog should clip the New Abstracts pages for *TEKniques* and insert them in the back of the catalog. Those who do not have a copy of the catalog may order it through Tektronix Central Parts Ordering (see New Abstracts section for information) by part number 062-6343-00, or may call the local Tektronix Field Office. 

Tektronix 4115B Computer Display Terminals Tailored for Demanding Graphics Applications

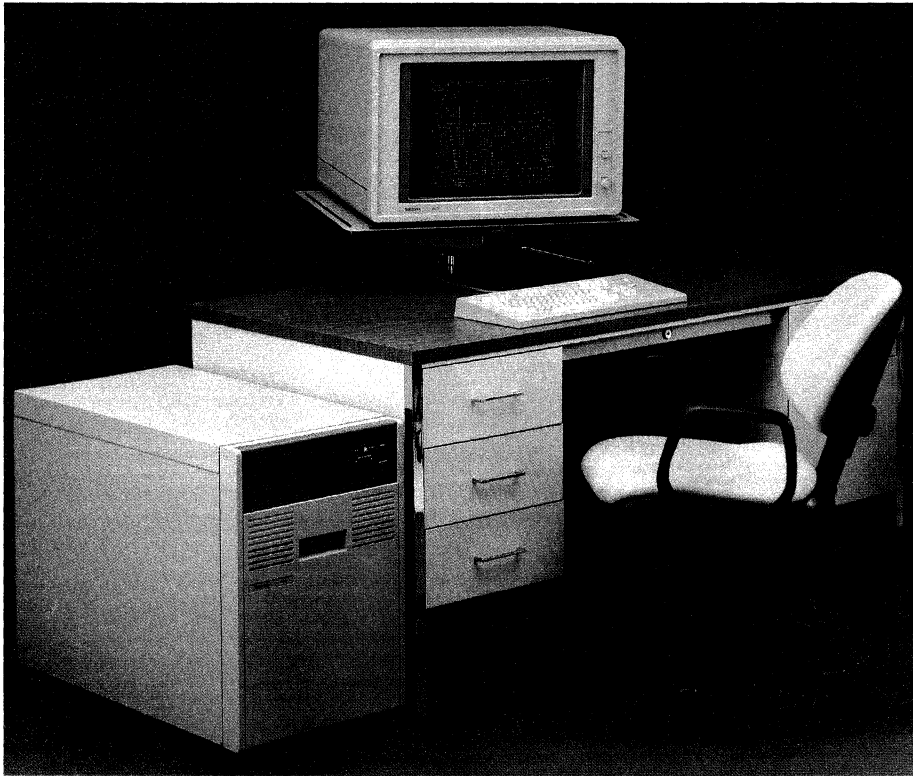

The 4115B is available in two packages: a pedestal configuration shown on the front cover of *TEKniques*, and the modular configuration shown above which separates the display, keyboard and processing components.

Extending the upper spectrum of Tektronix graphics terminals, the Tektronix 4115B Computer Display Terminal sets new standards for performance and graphics excellence.

A display of unparalleled resolution and speed, data communications at twice the rate of many existing terminals and local graphics intelligence tailor the 4115B for the rigorous graphics environments of electrical, mechanical and architectural engineering, and cartography. Its expanded coordinate space and local zoom and pan can handle extensive drawings without sacrificing detail.

The 4115B maintains compatibility with other Tektronix terminals and is designed to be easily integrated with the 4110 Series and solution vendor software. It is fully supported by the Tektronix PLOT 10 Interactive Graphics Library of Software and Local Programmability.

An Ergonomic Display

The 4115B's display is easy on the eyes. More than an aesthetic consideration, its properly

designed high resolution display (see sidebar) increases productivity by allowing the user to work at the terminal longer and more comfortably.

The 19" screen and 1280 × 1024 pixel resolution of the 4115B portray more visible detail with smooth shading and smooth lines. Optimum contrast ratio and precise alignment of the color beams guarantee sharp colors and crisp images. Data is displayed accurately. Bright, no smear pictures result from the fast sweep and consistent energy of the electron writing beams and use of low-persistence phosphors.

A special dialog area on the 4115B's screen permits host communication, menus and similar tasks to be distinct from those defining the graphics image. The dialog area may be turned on or off and may be erased separately; messages can be sent directly to the dialog memory for viewing later. Complying with ANSI X3.64 standards, the dialog area command set supports popular screen text editors.

Colorful Performance

The 4115B embodies all the significant features of the 4110 Series terminals* and more. Segment manipulation, patterns, markers, multiple line styles, user-definable fonts, windows and viewports, and GIN (graphic input from thumbwheels or tablet) are all part of the 4115B's repertoire.

From a palette of more than 16 million colors, the 4115B can display up to 256 at a time, providing realistic shading of complex objects. But often it's not the quantity of colors in a drawing that's important, but their facility to separate layers of a drawing.

Up to eight separate display surfaces from eight bit planes provided by the 4115B permit the user to manipulate data as layers with control over visibility. By assigning all eight bit planes to one surface, up to 256 colors may be used to display shaded solid objects. Or, if the drawing consists of several layers, such as a printed circuit board design, one bit plane may be assigned to each surface permitting eight layers of the drawing to be displayed and discriminated by color.

Responsive Graphics

The drawing speed of the 4115B is accomplished by a Tektronix-designed bit-slice bipolar processor. A picture composed of 50,000 vectors can be drawn in a second. Panels can be filled at the rate of 10,000 rectangles per second, and large areas can be color filled at up to 125 million pixels a second.

The 4115B's four billion × four billion coordinate space, the largest available, enables a user to define integrated circuit geometry with resolution greater than one one-thousandth of a micron, or large area maps with resolution of one centimeter. Once defined and stored, true zoom and smooth pan permit the user to roam around in the drawing, zooming in for a closer look, magnifying portions to display more and more of the drawing's discrete points.

Compatible Peripherals

So that the display may be copied for reports or handouts, the 4115B has a standard interface for the Tektronix monochrome 4634

*The last three issues of *TEKniques* - Vol. 6 No. 3, Vol. 6 No. 4 and Vol. 7 No. 1 - have discussed in detail the 4110 terminals and local programmability.

copier. An optional interface permits plug compatibility with the high performance Tektronix 4691 Color Copier.

When the optional three port peripheral interface is installed, copies may also be sent to the Tektronix 4662 or 4663 digital plotters.

Locally Programmable

Highly interactive pre- and post-processing functions of CAD can be moved to the 4115B, with a local programmability option, freeing the host for calculation-intensive analyses. Running digitizing and editing operations on the 4115B while using the host's power for database management is particularly useful to CAD and cartographic applications.

The software tools supplying local programmability to the 4115B maintain compatibility with the other 4110 graphics terminals. Features include the CP/M-86® operating system from Digital Research, Intel's FORTRAN-86 language, appropriate assemblers, linkers, loaders, and file utilities. One of the most valuable features of Local Programmability is the ability to directly access all of the graphics functions of the 4115B from a FORTRAN program through call statements. The user may easily write FORTRAN application programs that use all of the graphics capabilities of the 4115B.

Speedy Communications

While local graphics operations of the 4115B and local programmability cut down on host communication and costs, data transmission is still a vital part of the system. Sustained 4010-style graphics and alphanumeric may be transmitted over the RS-232-C data link up to 19.2K baud - twice the speed of many terminals.

An optional high-speed DMA interface to the DEC VAX is available that provides communication at the rate of one million bytes per second at distances of up to 1000 feet.

Flexible Packaging

Configured for flexibility and ease of use, the 4115B comes in two packages. The pedestal package includes a detached keyboard and a

pullout work surface suitable for the keyboard or a 20" x 20" tablet. The display sits on the pedestal cabinet which houses the electronics.

The modular version (M4115B) uses the same keyboard and display, but houses the electronics in a separate module. Styled to fit under a desk or table, this module may be configured with the same options as the pedestal and provides the user with additional flexibility in configuring workstations. The separate keyboard and display connect to the electronics module with 10-foot (3 meter) cables.

A variety of keyboard and power options tailor the terminal for international use.

A Sensible Choice

The 4115B heads an extensive line of Tektronix graphics terminals including the 4010 Series, the 4110 Series, and the newly in-

roduced 4100 Series. The compatibility of the terminals and their peripherals enables users to fit the configuration to the task for maximum performance for their investment.

For more information on the Tektronix 4115B Computer Display Terminal and other Tektronix graphics products, contact your local Tektronix Sales Engineer. 

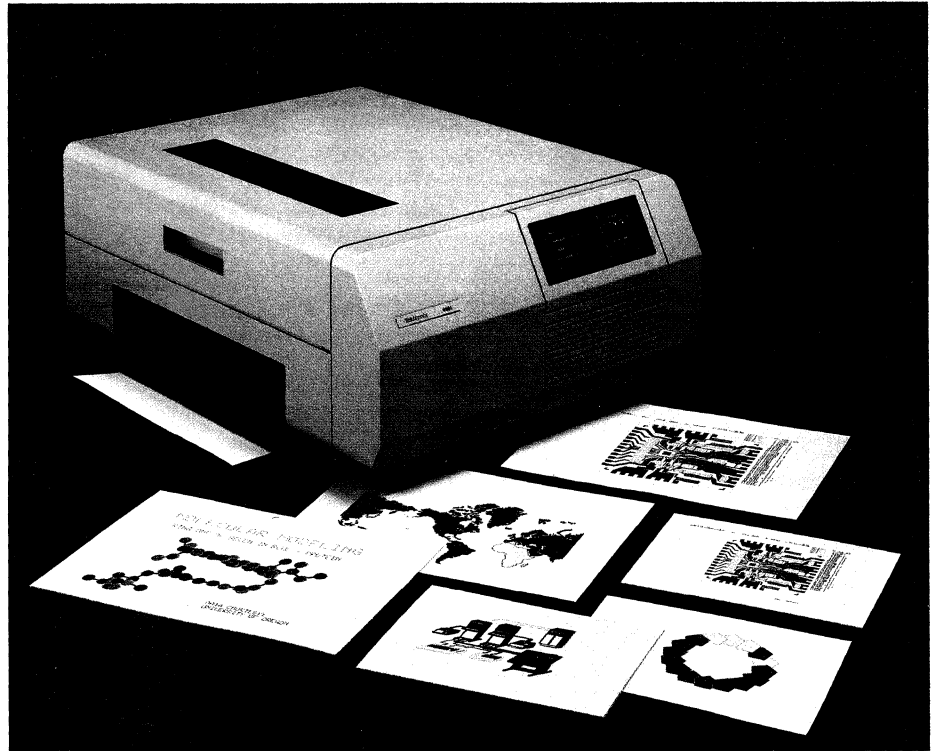

Plug compatibility with the Tektronix high performance 4691 Color Copier is provided to the 4115B color terminal through an optional interface.

High Resolution Resolved

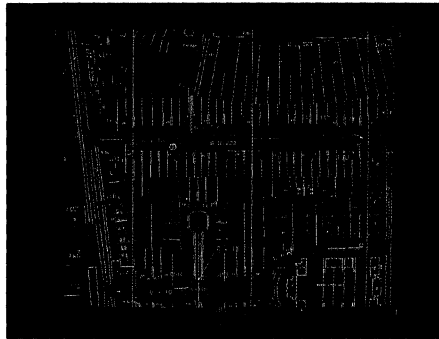
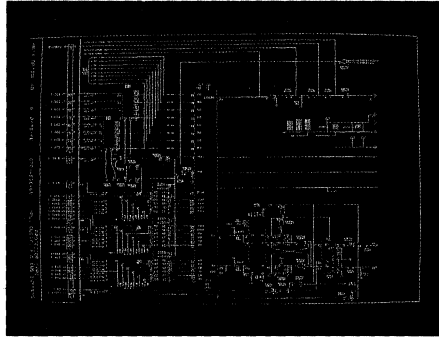
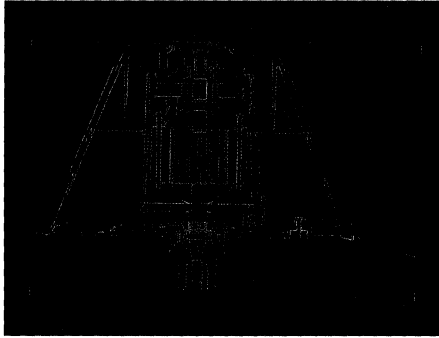

Though its 1280×1024 display resolution places the 4115B among the highest performance color raster-scan displays, high resolution is not purely a result of the number of lines on the screen. Many automobile manufacturers promote a similar fallacy when they confuse “high performance” with speed. A car’s performance is actually a combination of speed, handling, suspension, cornering, and other factors. High resolution in computer displays is also a combination of factors: number of lines or displayed pixels, refresh rate, contrast ratio, spot size, spot profile, brightness and convergence.

Line Number. A top speed of 120 mph is not very useful if the car starts to dangerously waver at 80 mph. A display with 1500 lines is also superfluous if the increased line number causes a decrease in visual resolution. The 1024 lines of the 4115B is the highest line number currently possible without sacrificing resolution.

Line number is closely related to two other variables that affect resolution: the screen spot size and the spot profile. Generally speaking, the smaller the screen spot size, the better the resolution. On the 4115B, the spot size is as small as present large screen raster-scan technology allows.

The spot profile is a measure of the energy distribution throughout the electron beams as they scan the screen. The beam energy should be evenly divided over the spot, not more intense in the center and much hazier at the perimeter. Too high a line number negatively affects the spot profile, which decreases resolution. Tektronix found that the benefits of a display with more than 1024 lines would be offset by poor spot profile and a loss of resolution.

Refresh Rate. The 4115B uses a 60 Hz non-interlaced display, meaning that the entire

picture is refreshed (or redrawn) 60 times every second. This refresh rate greatly reduces flicker so that the user can work at the terminal with less eye fatigue than possible with a 30 Hz interlaced display.

A 60 Hz noninterlaced display does not completely eliminate flicker. At this time, however, any attempt to further reduce flicker by changing the refresh rate would *decrease* a display’s resolution.

The 60 Hz refresh rate permits the use of low-persistence phosphors in the graphics display, eliminating smearing when graphics entities are moved around on the screen. This is important in CAD applications where the user “drags” objects into position on the screen or where objects are animated to simulate movement in the design.

Contrast Ratio. Display engineers have long known that too low a contrast ratio contributes to visual fatigue. While researching the 4115B, Tektronix discovered that visual fatigue can also result from too high a contrast. Images can appear to “float” in a display with too high a contrast. Studying the ability of the viewer’s eyes to focus on the display helped determine an optimum range for the contrast ratio. The 4115B’s neutral density filter maintains an appropriate contrast between foreground and background colors on the screen. The two other components of the

contrast equation, phosphor efficiency and beam energy, were selected to provide both the optimum contrast and long tube life.

The 4115B’s filter uses optical coatings to reduce the glare of room lighting while maintaining the display’s resolution. Other common filtering techniques such as faceplate etching and micro-mesh tend to reduce resolution.

Convergence. Convergence is the condition in which the red, green, and blue beams of a color raster-scan display intersect at a specified point on the screen. Misconvergence, a problem common to all color displays, occurs when the beams do not intersect correctly. The effects of misconvergence include poor color, a fuzzy picture, visual fatigue, and even a loss of graphics information. Convergence is crucial on a high-resolution display. In a high-density graphics application (integrated circuit design, for example), if the beams are not properly converged, two parallel yellow lines with only a small gap between them may appear as one thick white line. The misconvergence could lead to a serious design error.

For many high-resolution displays, a technician must frequently adjust the convergence, an often time-consuming and costly procedure. The 4115B’s technique of digital convergence, however, enables the operator to fine-tune the convergence allowing for local variations in temperature and magnetic field through the keyboard controls. The terminal is shipped from the factory with the approximate convergence values for the display stored in local memory. Initiating the specified self-test procedure automatically restores convergence to these digital values.

The autoconvergence option automatically corrects the natural drift that occurs in the alignment of the color writing beams in the CRT. A feedback mechanism senses and corrects misconvergence without the need for costly and time consuming technical assistance. The technique provides continuous optimum convergence for the highest possible display quality. 

Tektronix Disk Subsystems: Compact and Capable

by Gordon Gunderson
Tektronix, Inc.
Wilsonville, OR

Two new disk units from Tektronix permit 4100/4170 system users and 4110 terminal users to exercise the full power of local programmability.

Featuring a state-of-the-art and proven level of Winchester technology, the Tektronix 4926 10 MB Hard Disk provides a viable on-line memory subsystem. Its fast access time and data transfer speed make the 4926 ideal for storing the CP/M-86® operating system, utilities, compilers and other software tools which implement local programmability. Its high capacity allows plenty of room for programs and data storage; larger applications may be executed in standalone mode.

Using the popular 5¼" Winchester technology which seals media and read/write heads, the 4926 supports a formatted capacity of 10 megabytes, and an average access time of 85 milliseconds. The Mass Storage Interface (see sidebar) provides direct memory access to the 4170 Graphics Processing Unit or 4110 Computer Display Terminal from the 4926.

Packaging design of the 4926 permits a second hard disk drive to be included in the same cabinet. Known as the 49256 Opt. 26, the two hard disks provide a total of 20 MB of storage, using the same controller. Since the Mass Storage Interface Bus can handle up to seven controllers, additional 4926 Hard Disk units may be added for more capacity, dependent upon the operating system's drive addressing parameters. Under the current CP/M-86® implementation, the maximum



Each 500 KB double-sided disk of the Tektronix 4925 Flexible Disk Unit provides 327 KB of formatted storage or more than 650 KB in total.

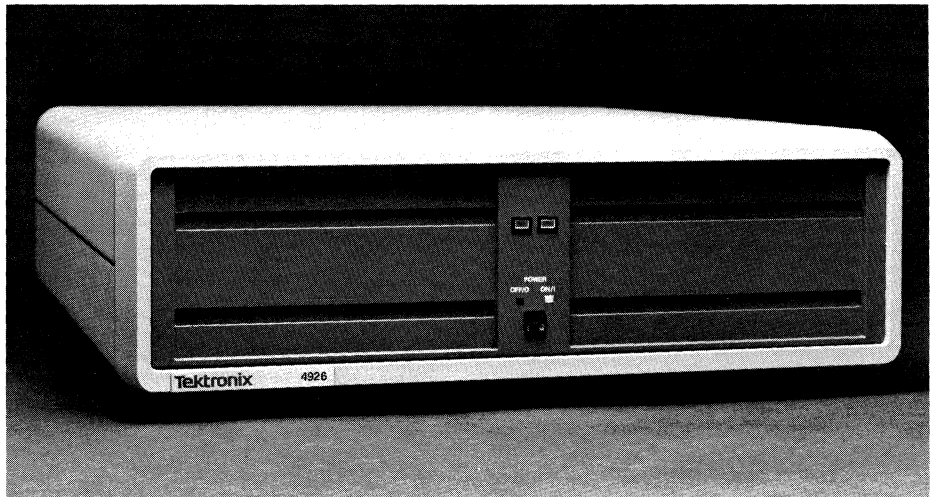

Providing 10 MB of formatted storage, the Tektronix 4926 Hard Disk unit interfaces to the 4170 Local Programmability unit or the 4110 Terminals.

Easy Interfacing

The Tektronix Mass Storage Interface (MSI) is an intelligent, high performance interface option for the Tektronix 4170 and the 4110 Series of terminals. Installed in the 4170 Graphics Processing Unit or 4110 Computer Display Terminal, the MSI includes a dedicated controller for internal flexible disks, and direct access to system memory for speedy data transfer.

It features the Tektronix Mass Storage Interface Bus (MSIB), a new Tektronix standard that conforms to the commonly used SCSI (Small Computer System Interface, ANSI X3T9.2) previously known as SASI (Shugart Associates Standard Interface). The MSIB, therefore, is a flexible and multi-purpose interface that can accommodate a spectrum of mass storage device types and performance levels.

The MSIB can accept up to seven mass storage controllers. For instance, a two-drive Winchester (4926 Opt. 26) and a 4925 Dual Flexible Disk Unit would take up only two of the seven controller addresses. More than enough room remains for additional disk units or for future MSIB devices as they become available. Storage devices simply "daisy-chain" from one to another.

Winchester configuration would be two fully configured 4926s (four drives) or a total of 40 MB.

A mass storage companion to the 4926 Hard Disk is the Tektronix 4925 Dual 5¼" Flexible Disk. Identical to the drives that come standard with the 4170 Graphics Processing Unit, the 4925 dual flexible disk drives provide economical secondary storage or removable backup media for the 4926 Hard Disk.

More important, the 4925 dual flexible disk provides a smooth and convenient path for software migration between the 4100 Series at one end of the Tektronix graphics spectrum to the 4110 Series at the other. When interfaced to a 4110 Terminal equipped with Local Programmability, the 4925 enables software and data files from a 4170 to be used directly by the 4110 Terminal which features 8" flexible disks. Each disk in the 4925 is double-sided double density with a formatted capacity of 327 KB each, or over 650 KB total.

For space savings, the dual floppy drives can be configured in the same cabinet as the

Hard Disk (4926, Opt. 25). In one compact unit, the terminal user has the capacity of a hard disk and the convenience of flexible disks for removable backup of selected hard disk files.

Like the 4926 Hard Disk, the 4925 connects to the 4170 or 4110 through the Mass Storage Interface. 

Tektronix disk subsystems may be packaged in several configurations.	floppy	Winchester
	floppy	
floppy		
floppy		
The Tektronix 4925 includes two 5.25" dual flexible disks and controller in one cabinet.		Tektronix 4926 Opt. 25 packages the dual flexible disks and controller in the same cabinet with a hard disk.
	Winchester	Winchester
	Winchester	
		Tektronix 4926 Opt. 26 adds a second 10 MB Winchester disk for a total of 20 MB of storage in one cabinet with one controller.
The Tektronix 4926 comprises one 10 MB Winchester 5.25" hard disk and controller in a cabinet.		

4050 Series Interfaces to 4695 Color Graphics Copier

by **Mark Mehall**
Tektronix, Inc.
Wilsonville, OR

The 4050 Series Desktop Computers can produce alphanumeric and graphics on the new low-cost 4695 Color Graphics Copier through interfaces available from the Black Box Catalog Company and software assistance. Black Box manufactures two converters which change the RS-232 or GPIB of the 4050 Series into the Centronics-compatible parallel interface used by the 4695.

The IEEE-488 Printer Adapter (488-PA) converts parallel data on the GPIB to the proper format.

The SPI-1000C Serial to Parallel Interface, a buffered interface, is used with the 4050 Series Data Communications option; it requires a special ROM (SPIBB2 8 bit) when used with the 4695. Both interfaces can be used by the 4051, 4052, 4052A, 4054 or 4054A.

Because the Color Graphics Copier "draws" with dots, the vector graphics of the 4050 system must be converted (rasterized). A program will be available from the Program Ex-

change which will generate 4695 code from 4050 Series graphics information. Using a new graphics ROM pack (which will be announced in the next issue of *TEKniques*), the program adds color to coordinates, rasterizes the vectors, sorts on the descending Y and drives the printer.

Black Box Catalog address is:
P.O. Box 12800
Mayview Road at Park Drive
Pittsburgh, PA 15241
(412) 746-2910 

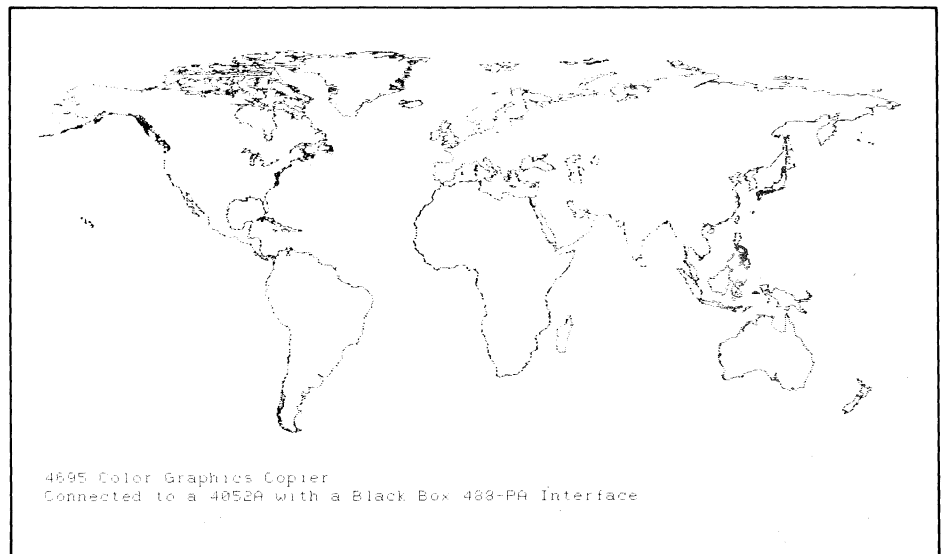

Mechanical Engineering/Integrated Circuit Design Aided by Software

Mechanical engineering and circuit design are the respective focus of three firms who have recently joined the Tektronix Solution Vendor Program. Their software offerings,

which support Tektronix 4010 and 4110 Series Terminals, may provide a solution to design/analyses problems in these disciplines.

Swanson Analysis Systems, Inc.
Johnson Road
P.O. Box 65
Houston, PA 15342
(412) 746-3304

Developed by Swanson Analysis Systems, Inc., the ANSYS program has been used in the structural, nuclear, mining, chemical and automotive industries since 1970. ANSYS employs finite element techniques to analyze structures (static and dynamic; elastic, plastic, creep and swelling; small and large deflections), and heat transfer (steady-state and transient; conduction, convection, and radiation). Structural and Heat Transfer analyses may be made in one, two, or three dimensions, including axisymmetric and plane problems. Coupled thermal-fluid flow capability, coupled thermal-electric capability, and wave motion analysis capability are also available.

Topics of just a few of the papers presented at a recent ANSYS Conference suggest the wide variety of engineering problems to which ANSYS has been applied:

vehicle design, dynamics modeling, rock mechanics/tunneling, large deflection analysis-cable structures, energy absorption, composite material evaluation, and thermal stress-fatigue evaluation.

A large-scale computer program, ANSYS is offered on a time-sharing basis or on in-house computer systems. It has been installed on VAX, IBM, PRIME, CDC, CRAY, UNIVAC, Honeywell, Harris, Data General, and other computers. ANSYS supports the graphics and intelligence of the Tektronix 4014, 4113, and 4114 Computer Display Terminals.

Swanson Analysis Systems personnel work closely with users to incorporate current technology and to improve the efficiency of the

solution process. The ANSYS Conference held in Pittsburgh in April, 1983, brought together ANSYS users who exchanged experiences, reviewed new hardware and services, and learned of current and future developments of ANSYS.

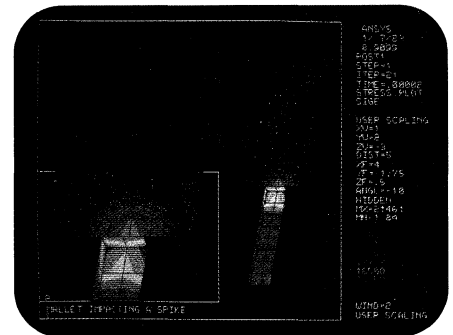

General Electric CAE International
300 TechneCenter Drive
Milford, OH 45150
(513) 576-2400

GE-CAE brings state-of-the-art mechanical engineering techniques to firms for designing, testing and manufacturing products. A main thrust of GE-CAE is the CAE software system. Originally developed by Structural Dynamics Research Corporation (SDRC), six mechanical engineering packages can be used independently or as an integrated system. All of the packages make full use of the graphics features of the Tektronix 4014 terminal and most support the 4113 and 4114 terminals.

Two modeling software packages help resolve potential design problems early in the product development cycle.

Using SDRC GEOMOD, an interactive modeling tool, engineers construct realistic geometric models of design components. SDRC GEOMOD's powerful mathematical and display capabilities aid users in exploring alternative design concepts and help generate a physical "feel" for their design. Component properties like volume, mass and inertia can be calculated and displayed instantly. Color-shaded image and hidden removal visualize these geometric representations without hardware prototypes. In addition, SDRC GEOMOD allows engineers to manipulate individual components and then assemble them into total mechanical systems. The

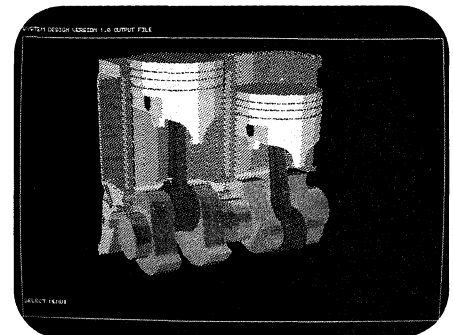

geometric information created in SDRG GEOMOD may be accessed directly for system simulation (SDRC SYSTAN) and other types of analysis.

SDRC SUPERTAB is a design/analysis tool. Individual component loads generated from the system design are used to design and analyze components. SDRG SUPERTAB enhances model generation and display techniques, and reduces the time required for tasks such as mesh definition and refinement.

SDRC SUPERTAB and SDRG GEOMOD can form a fully integrated engineering system to evaluate design data - from rough ideas to a detailed investigation of the entire product system - and ensure that only feasible designs are carried into the prototype or manufacturing stage.

Evaluating a system's response to its operating environment avoids last minute changes which can greatly impact product quality and development time.

SDRC SYSTAN, an interactive design-oriented analysis tool, combines component

models from a complex mechanical structure into a single model to mathematically predict overall system performance. Engineers can use SDRG SYSTAN to construct and verify the system model, determine system characteristics and evaluate system performance with a single program.

SDRC SUPERB is a general purpose finite element program with superior capabilities for static and dynamic structural analysis and heat conduction analysis. When coupled with SDRG SUPERTAB, extensive output display capabilities make it easier for engineers to interpret complex results.

A family of interactive beam analysis programs, SDRG FRAME helps engineers perform static, dynamic, limit and buckling analysis of complex frame and truss structures. Complete diagnostics and geometric displays provide fast model debugging.

Whether its existing products and components, or the first prototype built, mechanical tests provide pertinent information to the design team. SDRG MODAL-PLUS is an in-

teractive software package used to collect, analyze and display data from controlled excitation tests. A physical model is vibrated by an exciter through a range of frequencies to test system dynamics. SDRG MODAL-PLUS then creates a mathematical model of the prototype's performance that can be compared to the system model.

VR Information Systems, Inc.
5818 Balcones Drive
Austin, TX 78731
(512) 458-8131

MERLYN-G is an integrated set of layout tools that allows the user to personalize VLSI gate arrays to implement various circuit designs. This flexible set of tools is independent of the chip manufacturer or style of gate array. It functions equally well for vendor design of new chip floorplans or end-user layout of existing chips. Inputs to MERLYN-G consist of a gate array reference database (from the gate array vendor) and user defined circuit specifications.

MERLYN-G completes a chip personalization in four phases: 1) Preprocessing combines the user design specification with the chip reference data and creates a repository chip design file. 2) Component placement performs an initial, logic macro/cell placement. An interactive graphic placement editor allows manual manipulation of macro placement. 3) Routing defines the connection requirements and generates the wire paths. Algorithms and utilities are available, including a graphic wiring editor for definition of uncompleted connection requirements. 4) Post-processing includes routines for hard copy output of the completed chip design file, and interfaces to pattern generation tape systems.

The MERLYN-G software subsystems can be linked together to create a unique layout strategy based on a specific chip style. Each subsystem has many processing options used in developing this strategy. Subsystem reports provide step-by-step results to assist in fine tuning. Finished design strategies can then be built into system control files which subsequently will be transparent to circuit design engineers.

MERLYN-G fully supports the intelligence and graphics features of the Tektronix 4113 Computer Display Terminal. 

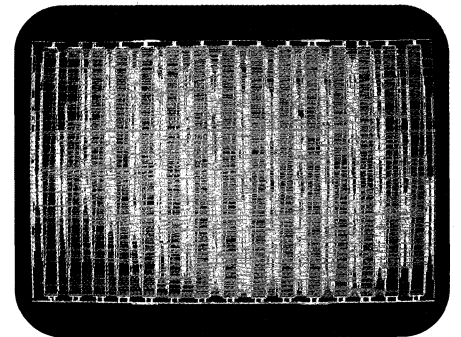

Programming

Tips

Outputting to a Plotter from the 4110 Series Terminals

When a drawing is sent to a plotter from a 4110 graphics terminal, three factors may affect the plot: whether the data comes from the terminal's disk or from its memory; if from memory, which terminal it is, and which command is used to send it.

Four commands transfer data from the terminal to a plotter:

COPY and SPOOL transfer data from the terminal's disk.

SAVE sends specific graphics segments from memory.

PLOT sends all currently visible segments from the memory of the 4114. From the 4112 or 4113, PLOT sends current settings for the

current view's window and viewport to the plotter. Then it sends all segments (or parts of segments) visible in the current view.

Alphatext in a Drawing

COPY/SPOOL - 4010 character size commands (ESC8 ESC9 ESC: or ESC;) in a disk file from any of the terminals will be executed by the plotter, thus will affect alphatext being plotted.

SAVE/PLOT - Because 4010 character size commands aren't recognized by the 4112 and 4113 display firmware, they are never stored in memory. Consequently, alphatext in a segment sent from the memory of either terminal won't be affected.

But the 4114 does recognize 4010 character size commands and stores them in memory. Therefore, alphatext in a segment sent from the memory of the 4114 will be affected.

Graphics in a Drawing

PLOT - On a 4112 or 4113 terminal, the *current* window and viewport settings affect the scale of the output to the plotter. This includes the default window and viewport. Because the default window is slightly larger (for compatibility with other Tektronix terminals) than the default viewport -

```
WINDOW 0 0 4095 3127
VIEWPORT 0 0 4095 3071
```

- the plotter drawing will be slightly smaller in the Y-direction than when using SAVE. The alphatext will be the same size as that output by SAVE, just slightly higher on the page.

By decreasing the size of the window to match the viewport, the same size graphics output may be obtained; but PLOT clips at the top of the display whereas SAVE doesn't.

A 4114 terminal doesn't have window and viewport commands, so graphics output is the same size for all four output commands.

SAVE/COPY/SPOOL - These commands do not consider *current* viewport and window so graphics output is the same size for the three terminals.

Graphtext in a Drawing

Commands within a disk file which scale and rotate stroke precision graphtext are not translated to plotter commands. These commands, however, are executed by the terminal's firmware when a file is loaded into memory from disk.

To match plots on the terminal with those on the plotter, load the file to be sent to the plotter into memory. (If the file doesn't contain segments, the entire file should be made into a segment.) By running the contents of the file through the terminal's display processor, rotated and scaled graphtext are converted to moves and draws. Next, SAVE the contents of the file in memory back to the disk under another filename. The SAVE'd version of the file containing moves and draws which the plotter driver can interpret may then be spooled to the plotter. It will produce the same plot as the original version of the file.

3PPI to plotter			
	memory	disk	
plot	NO	NO	execute 4010 character commands transfer current window/viewport interpret graphtext commands
save	YES	YES	
copy	NO	NO	
spool	NO	NO	

4112/4113

3PPI to plotter			
	memory	disk	
plot	YES	YES	execute 4010 character commands transfer current window/viewport interpret graphtext commands
save	YES	YES	
copy	NO	NO	
spool	NO	NO	

4114/4116A

CCINPUT in the 4050A Series

by Lee Rainey
Tektronix, Inc.
Dayton, OH

CCINPUT, one of the new commands in the A-Series of 4050 Desktop Computers, brings in characters one at a time from the type-ahead buffer. This facility supports several applications including forms fillout and tabbing, in which the operator either keys into a field of the form or presses TAB to advance to the next field.

In the following example lines 100-250 display the form. The Character and Symbol ROM pack is handy for clearing the buffer of stray keystrokes before beginning the CCINPUT sequence (line 270).*

The CCINPUT technique occupies lines 310-340. A single refresh character prompts the operator. CCINPUT then checks the type-ahead buffer. If the buffer is empty, a null string results and the program redisplay the prompt. When a character is received, it is checked in line 350 for a TAB (recall that 137 is the pseudo-ADE for the TAB key). If a non-TAB character, it's displayed and GIN updates the prompt position. A TAB character ends the column input and "tabs" to the next position by printing an appropriate number of spaces.

Another CCINPUT application allows right margin wraparound to input more than 72 characters before a RETURN.

Or CCINPUT could be used to mimic the DEC 20 operating system use of ESC. On the DEC, you need not type the entire name of an existing file; just enter enough characters to avoid ambiguity, followed by an ESC. On the 4050A, CCINPUT could look for the ESC and then pad the characters entered with the ? wildcard character to produce a partial name that could be located in full by a call to FILE: 

*Editor's Note: Clearing the buffer can also be accomplished using CCINPUT. Simply execute a loop inputting from the buffer until you get a null string.

```

100 REM - FORM FILLOUT USING CCINPUT
110 INIT
120 PAGE
130 DIM Y_cursor_pos(3)
140 PRINT "FILL IN EACH FIELD WITH 0-8 CHARACTERS. TERMINATE EACH ";
150 PRINT "FIELD BY"
160 PRINT "PRESSING THE TAB KEY."
170 PRINT
180 IMAGE FA,21T,FA,41T,FA,61T,FA
190 PRINT USING 180:"COLUMN 1","COLUMN 2","COLUMN 3","COLUMN 4"
200 PRINT
210 FOR I=1 TO 3
220   GIN X,Y_cursor_pos(I) !OBTAIN Y LOCATION FOR EACH LINE
230   PRINT USING 180:"-----","-----","-----"
240 NEXT I
250 Field$=""
260 FOR I=1 TO 3
270   CALL "CLRBUF" !CLEAR BUFFER BEFORE EACH LINE (WITH R11 ROM)
280   N=0
290   X=0
300   FOR F=1 TO 4
310     MOVE X,Y_cursor_pos(I)
320     PRINT @32,24:"?" !DISPLAY REFRESH ? AS PROMPT
330     CCINPUT C$
340     IF C$="" THEN 320 !LOOP UNTIL A CHARACTER COMES IN
350     IF ASC(C$)<>137 THEN
360       Field$=Field$&C$ !EXECUTED WHEN CHARACTER IS NOT TAB
370       N=N+1
380       PRINT C$;
390       GIN X,Y_cursor_pos(I)
400     ELSE
410       Field$=Field$&"I" !EXECUTED WHEN CHARACTER IS TAB
420       IF F=4 THEN 500
430       FOR T=N+1 TO 20 !PRINT SPACES TO ACCOMPLISH TAB
440         PRINT " ";
450       NEXT T
460       GIN X,Y_cursor_pos !OBTAIN POSITION TO DISPLAY NEXT PROMPT
470       N=0
480     END IF
490     GO TO 1+(ASC(C$)=137) OF 310,500
500   NEXT F
510 NEXT I
520 PRINT
530 PRINT "JDONE"
540 END

```

FILL IN EACH FIELD WITH 0-8 CHARACTERS. TERMINATE EACH FIELD BY PRESSING THE TAB KEY.

COLUMN 1	COLUMN 2	COLUMN 3	COLUMN 4
LOIS----	AND----	LOIS---	QE-----
QBIB----	-----	QUICK---	ADD-----
EASY----	WITH----	CCINPUT-	QB_40500

DONE

TEKniques

TEKniques is published by the Information Display Division of Tektronix, Inc. Its application articles and news of new Information Display Division products will be of interest to managers of graphics related projects. Qualified individuals who return the following form may receive *TEKniques*.

Name _____ Date _____

Job Title _____ Tek Sales Engineer _____

Company _____ Department _____

Address _____

City _____ State _____ Zip _____

May we phone you for a discussion about your application? Yes, phone _____

Primary Product Interest Area (check one)

- Graphics Terminals
- Intelligent Graphics Terminals
- CAD Workstation
- Desktop Graphics Computers
- Other Graphics Devices _____

Please evaluate *TEKniques*

	Very Useful	Useful	Not Useful
Applications Articles	<input type="checkbox"/>	<input type="checkbox"/>	<input type="checkbox"/>
New Product Information	<input type="checkbox"/>	<input type="checkbox"/>	<input type="checkbox"/>
Programming Tips	<input type="checkbox"/>	<input type="checkbox"/>	<input type="checkbox"/>
New Abstracts	<input type="checkbox"/>	<input type="checkbox"/>	<input type="checkbox"/>
Other _____			
Other features you would like to see included _____			

Your Relationship with/to Computer Graphics (check all that apply)

- Operator of a Tektronix graphics product
- User of the output of Tektronix graphics products
- Programmer of Tektronix graphics products
- Manager of Tektronix graphics product operators/users
- Manager of graphics programmers
- Specify graphics product purchases
- Approve graphics product purchases

Second Request

If you returned this form from the last issue, please ignore this request and accept our thanks.

Fold here



NO POSTAGE
NECESSARY
IF MAILED
IN THE
UNITED STATES

BUSINESS REPLY MAIL

FIRST CLASS PERMIT NO. 1 BEAVERTON, OR

POSTAGE WILL BE PAID BY ADDRESSEE

TEKTRONIX, INC.
Information Display Division
IDD Program Exchange
Mail Stop 63-575
P.O. Box 1000
Wilsonville, Oregon 97070

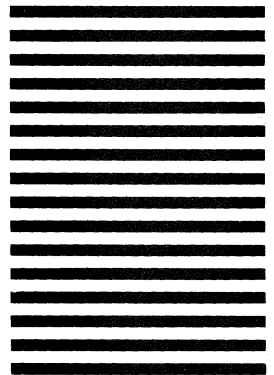

Tektronix Computer Graphics Supplies

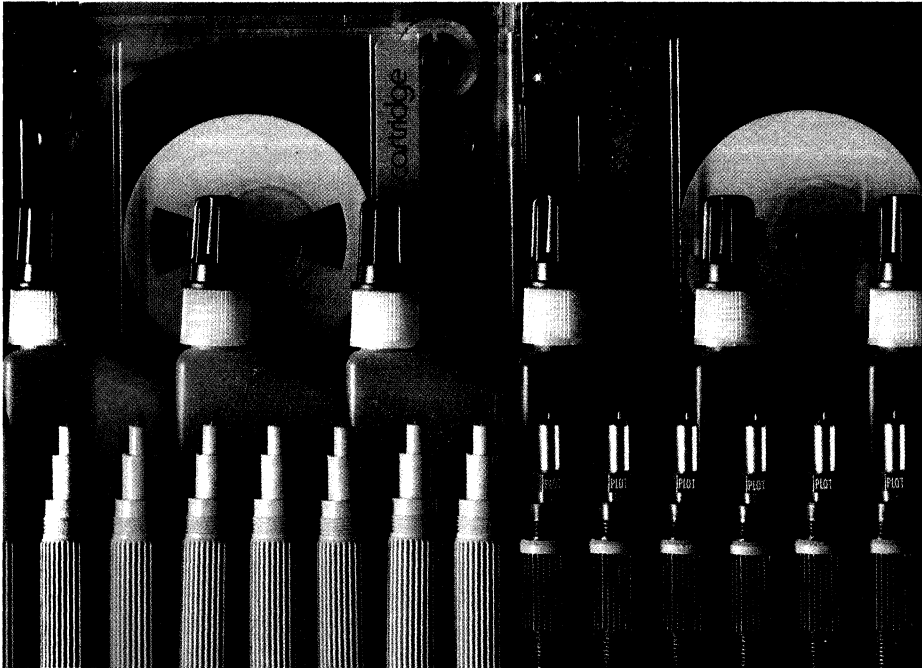

Transparency Film

Part numbers for transparent film will be announced shortly.

Ink Cartridges

Each package contains 2.5 cc each.

Yellow	016-0734-00
Magenta	016-0735-00
Cyan	016-0736-00
Black	016-0737-00

The above 4 products should provide enough ink for approximately *1600 typical copies* or several months' supply.

Paper

Roll Format 016-0743-00

Each box contains 6 rolls of 10" wide ink jet copy paper, 50 meters long. This provides enough paper for about *1000 copies*.

Sheets Format

Each package contains *500 sheets* of paper.

A size (8½ × 11 in.) 016-0739-00

A4 size (210 × 297 mm) 016-0740-00



A New Catalog

A new eight page catalog simplifies identifying and ordering Supplies Products for Tektronix copiers, plotters, printers and storage devices. Photographs, descriptions, part numbers and order information for media, pens and ink available from Tektronix are included in the Computer Graphics Supplies Catalog. It contains listings for approximately 120 products including 33 new offerings highlighted in color. If you haven't received your copy, ask you local Tektronix Sales Engineer for one.

Since the Catalog

The Tektronix low-cost 4695 Color Copier was introduced after the catalog was printed. Supplies available for the 4695 Copier are:

Liquids/Lubricants

Maintenance Liquid which keeps the heads from clogging when the printer is not being used (200 cc per bottle) 016-0732-00

Print Head Protect Liquid used for a long move or storage (10 cc) 016-0733-00

Lubricant for servicing copier (5 cc) 016-0742-00

IDD Program Exchange

The IDD Program Exchange is a central location of user software for Tektronix Graphics Display Products. As programs are received, they are collected into packages according to the product they support. The packages are available to all uses through exchanges for program contributions or for a nominal charge.

Program Contributions

Contribute one program to the Applications Library and receive the package of your choice in exchange. To receive documentation instructions and forms, contact the Program Exchange serving your area. In the U.S., you may TWX: 910-467-8708 or TLX: 15-1754.

U.S. Orders

Order IDD Program Exchange packages through the toll-free number of Tektronix Central Parts Ordering. The following map delineates the geographical regions and the toll-free number serving each region.

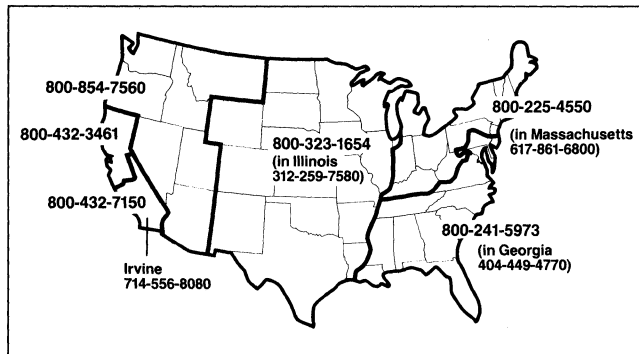

Call the number serving your area and give the customer service representative the nine-digit part number and name of the Program Exchange package you wish. If you have any questions, call your local Tektronix Field Office. The field office has the current prices. (Note: The minimum acceptable Tektronix order is \$25.00.)

Orders Outside U.S.

To order a copy of the catalog, or to order a package, contact the local Tektronix sales office or the Program Exchange serving your area. See Program Exchange Addresses section of *TEKniques*.

4000 Series Graphics Terminals

The 4010, 4020 and 4100 Series programs are packaged and nomenclated with the appropriate prefix and disk number.

Each package includes media with the source code together with the supporting documentation; listings are not included. Documentation may be purchased separately.

A 4000 Series catalog will be published when a sufficient number of packages are collected.

Package Title	Documentation Part #	Package Part #
4110 LP Program Exchange		
Disk 1.....	062-6955-00 062-6955-01

4050 Series Desktop Computers

The 4050 Series programs included in the IDD Program Exchange prior to September 1981 are packaged and nomenclated by function. Those programs accepted after September 1981 are packaged and nomenclated with the Volume and Number of the corresponding issue of *TEKniques* in which the package was announced.

Each package includes the source code on tape or disk (T=tape; D=disk) together with the supporting documentation; listings are not included. Documentation may be purchased separately.

The 4050 Series IDD Program Exchange catalog contains the abstracts describing the programs in each package along with representative output in most cases. The catalog part number is 062-6343-00.

Package Title	Documentation Part #	Package Part #
Business Aids T1.....	062-5987-00 062-5987-01
Business Aids T2.....	062-5988-00 062-5988-01
CAD T1.....	062-5976-00 069-5976-01
CAD D1.....	062-5977-00 062-5977-01
Character Generator T1.....	062-5951-00 062-5951-01
Education/Research T1.....	062-5982-00 062-5982-01
Education/Research T2.....	062-5983-00 062-5983-01
Electrical Engineering T1.....	062-5978-00 062-5978-01
Graphing T1.....	062-5964-00 062-5964-01
Graphing T2.....	062-5965-00 062-5965-01
Graphing T3.....	062-5966-00 062-5966-01
Graphing D1.....	062-5967-00 062-5967-01
Graphing D2.....	062-5968-00 062-5968-01
Interfacing T1.....	062-5984-00 062-5984-01
Mapping T1.....	062-5980-00 062-5980-01
Mechanical Engineering T1.....	062-5979-00 062-5979-01
Programming Aids T1.....	062-5971-00 062-5971-01
Programming Aids T2.....	062-5972-00 062-5972-01
Project Aids T1.....	062-5985-00 062-5985-01
Project Aids D1.....	062-5986-00 062-5986-01
Recreational Plots T1.....	062-5989-00 062-5989-01
Slidemaker T1.....	062-5962-00 062-5962-01
Slidemaker D1.....	062-5963-00 062-5963-01
Text Processing T1.....	062-5969-00 062-5969-01
Text Processing D1.....	062-5970-00 062-5970-01
Utilities T1.....	062-5974-00 062-5974-01
Utilities D1.....	062-5975-00 062-5975-01
Tekniques Vol. 5 No. 4 T1.....	062-5981-00 062-5981-01
Tekniques Vol. 6 No. 1 T1.....	062-6443-00 062-6443-01
Tekniques Vol. 6 No. 1 D1.....	062-6442-00 062-6442-01
Tekniques Vol. 6 No. 2 D1.....	062-6515-00 062-6515-01
Tekniques Vol. 6 No. 3 D1.....	062-6516-00 062-6516-01
Tekniques Vol. 6 No. 3 T1.....	062-6514-00 062-6514-01
Tekniques Vol. 6 No. 4 T1.....	062-6704-00 062-6704-01
Tekniques Vol. 7 No. 1 D1.....	062-6715-00 062-6715-01

Software Support Category C

The program material contained herein is supplied without warranty of any kind, and without any representation regarding quality, performance or suitability. TEKTRONIX specifically disclaims any implied warranties of merchantability of fitness for a particular purpose. Software support is TEKTRONIX Category C: Software is provided on an "as is" basis.

IDD Program Exchange

Africa, Europe, Middle East

Contact local sales office

Australia

IDD Program Exchange
Tektronix Australia Pty. Limited
Sydney
80 Waterloo Road
North Ryde, N.S.W. 2113

Canada

IDD Program Exchange
Tektronix Canada Ltd.
P.O. Box 6500
Barrie, Ontario
Canada L4M 4V3

Caribbean, Latin America and Far East (excl. Japan)

IDD Group
Export Marketing
Tektronix, Inc.
P.O. Box 500
Beaverton, Oregon 97077
U.S.A.

Japan

IDD Program Exchange
Sony/Tektronix Corporation
9-31 Kitashinagawa-5
Tokyo 141 Japan

United States

IDD Program Exchange
Tektronix, Inc.
Mail Stop 63-575
P.O. Box 1000
Wilsonville, Oregon 97070

Tektronix
COMMITTED TO EXCELLENCE

TEKTRONIX, INC.
Information Display Division
Tekniques
Mail Stop 63-575
P.O. Box 1000
Wilsonville, Oregon 97070

BULK RATE
U.S. POSTAGE
PAID
TEKTRONIX, INC.

CHARLES KOH
PATHFINDER MINES CORP
550 CALIFORNIA ST
SAN FRANCISCO, CA 94133

Address Correction Requestion — Forwarding and Return Postage Guaranteed.

The Tektronix color graphics spectrum ranges from the low-cost 4105 terminal and 4695 copier to the high performance 4115B terminal and 4691 copier.

