

Tekniques

The 4050 Series Applications Library Newsletter

November 1, 1980

Vol. 4 No. 7

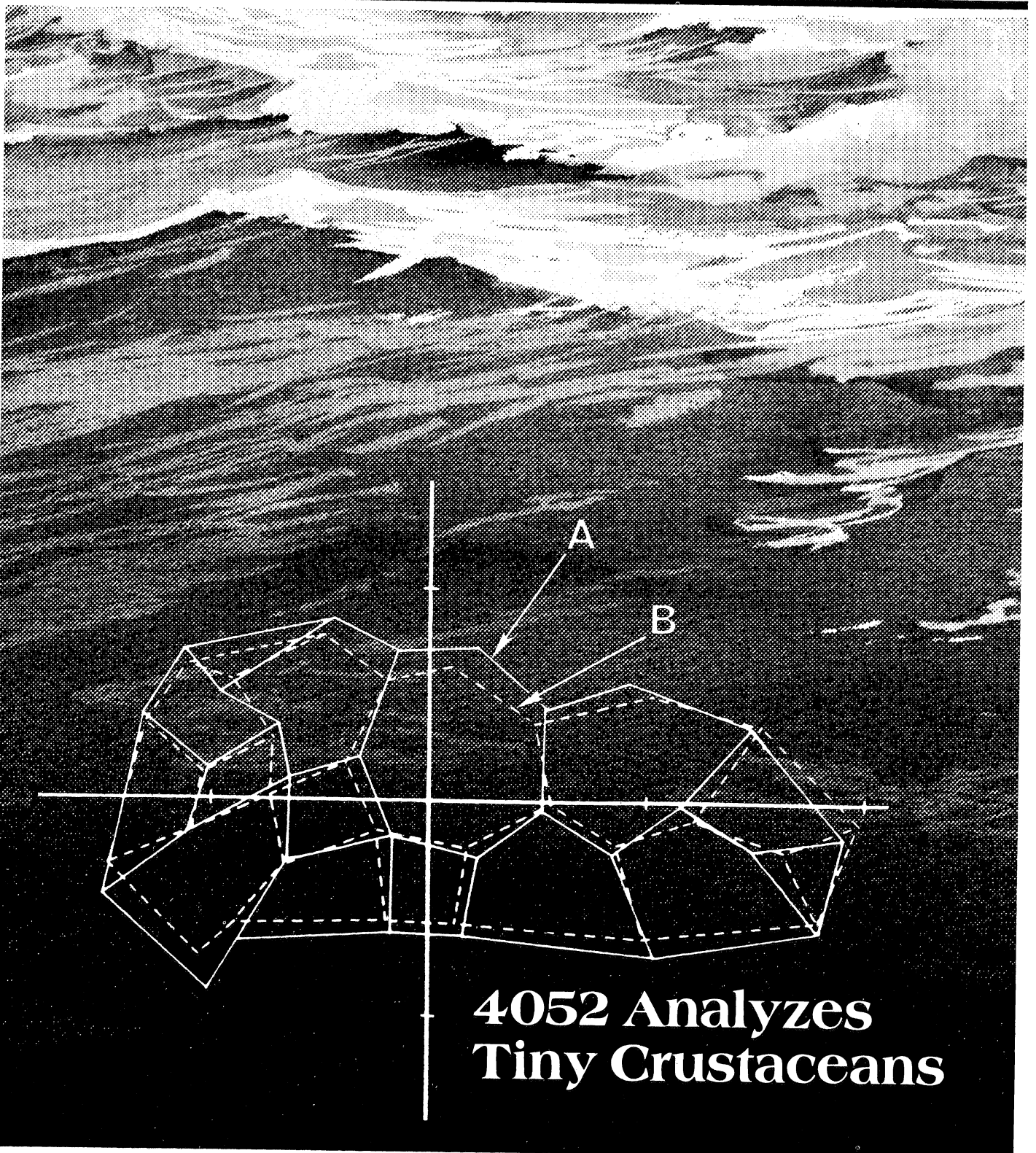

**4052 Analyzes
Tiny Crustaceans**

Tekniques

In This Issue

Behind the Exhibits at the Smithsonian Museum of Natural History: 4052 Analyzes Tiny Crustaceans 2

Expanding Your Measurement Capabilities: Introducing the 468 Storage Oscilloscope 5

Getting the Best Possible Copies from your 4631 Hard Copy Unit 5

Input/Output10

Wrong Caption, Wrong Photo ...10

New Contest to Stir Your Innovative Juices11

Editor's Note12

Programming Tips13

BASIC Bits.....13

New Abstracts21

TEKniques, the 4050 Series Applications Library Newsletter, is published by the Information Display Division of Tektronix, Inc., Group 451, P.O. Box 500, Beaverton, Oregon 97077. It is distributed to TEKTRONIX 4050 Series users and members of the 4050 Series Applications Library.

Publishing Manager	Ben Buisman
Managing Editor	Patricia Kelley
Editor	Terence Davis
Technical Editor	Dan Taylor
Graphic Design	John Ellis
Circulation	Rory Gugliotta

Copyright © 1980, Tektronix, Inc.
All rights reserved.

To submit articles to TEKniques or for information on reprinting articles, write to the above address. Changes of address should be sent to the 4050 Series Library serving your area (see Library addresses).

Behind the Exhibits at the Smithsonian Museum of Natural History: 4052 Analyzes Tiny Crustaceans

by Terry Davis
TEKniques Staff
with Patricia Kelley
TEKniques Staff

Within the Smithsonian Complex on the Capitol Mall in Washington, D.C. is the National Museum of Natural History. The museum is a fascinating resource on people, their natural surroundings, and the history of those surroundings. Dr. Richard Benson

is a research paleobiologist and curator at the National Museum of Natural History, and a professor of Geology at the University of Kansas. For 25 years, Dr. Benson has been researching one particular field of natural history: investigating environmental factors of geological history through the Ostracoda, a microscopic crustacean with a very long evolutionary record (Fig. 1).

Dr. Benson works with several people in Italy and in France in his current research. Together they are studying the destruction of

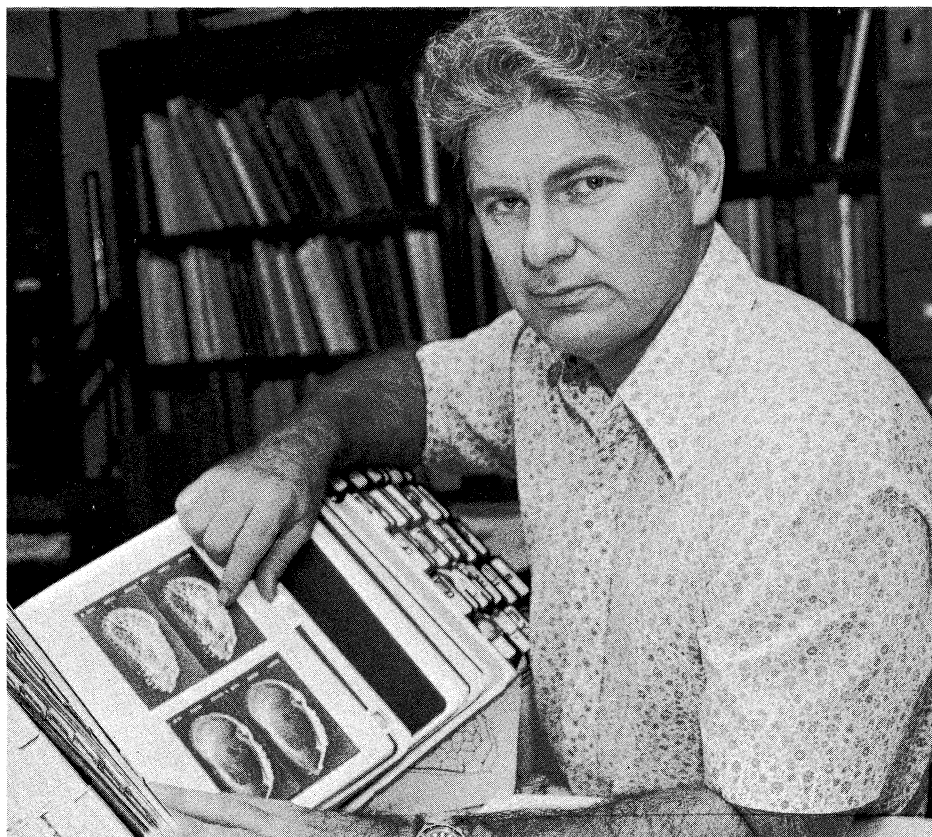

Fig. 1. Dr. Richard Benson of the Smithsonian Museum of Natural History points out a photo of one of the 3,000+ species of ostracodes contained within his atlas of Scanning Electron Microscope photos.

the Tethys Ocean (a major oceanic system that occurred where the Himalayas, Alps and Caucasus are today), and the formation of the Atlantic Ocean. The data that they use for their study come from the ostracodes and their structural development. The ostracode samples are obtained from the strata of Southern Europe, Northern Africa, and the Near East as well. In addition, they obtain samples from cores of the Deep-Sea Drilling Project which drills the ocean floor all over the world, and extract the microscopic animal fossils from them for examination. Their intent is to study the forms of these creatures throughout their long history in order to reconstruct events of the past.

Evolved Shape Reflects Environment

Recently, Dr. Benson replaced his HP 9820 with a TEKTRONIX 4052 Graphic Computing System. He is using the 4052 as the basis for a system that will help him characterize the Ostracoda based on their evolving shapes. From that, Dr. Benson and his fellow researchers hope to draw conclusions about the environment that influenced the changes in their shape. His attention is now focusing on developing a method of comparing pairs of specimens, matching one to the other and analyzing the differences in shape. The problem of matching one to the other gets very complex, making a very lengthy statistical procedure. But by doing so, and tracking the differences, Dr. Benson hopes to be able to string the Ostracoda types together in an evolutionary string.

A new method is currently being developed for comparing the shapes of the small, dome-like valves of the calcified carapaces (the hard outer shell of the creature) of the Ostracoda. The method is currently two-dimensional; a three-dimensional method is the eventual hope. In order to better understand the shape changes, architectural and engineering analysis must be included. In this way, the researchers may better understand the stresses in the curved surfaces, the strengthening ridges that form and the deformation that different environments might cause. Thus the forces that influence change may be determined.

4052 Graphically and Statistically Compares Shapes

Through better understanding of the architecture of the ostracodes, and by marrying that understanding with some engineering assumptions and some evolutionary assumptions, some quantitative relationships will develop. And by es-

tablishing the evolutionary chain of the Ostracoda, and interrelating that chain with the evolutionary and physical forces that influenced the changes, a tool will emerge to help reconstruct and understand the major changes that have taken place in the world's oceans. They're finding ways to use the 4052 graphically to compare the changes in shape over time.

Once specimens are collected, separated, sorted and photographed with the Scanning Electron Microscope (Fig. 2), the image of a

specimen is projected onto the surface of the 4956 Tablet. The image is then selectively digitized into the system using the tablet (Fig. 3). A number of these shape "frames" are input into the system, and recorded on tape or disc. The 4052 then performs point comparisons and transformations to obtain the best fit, and the digitized images are then plotted on the 4662 plotter. When the frames are plotted, the output is given in terms of the actual fit and also by the vectorial differences. The computing power of the 4052 won't be used for mathematical and statistical



Fig. 2. Dr. Benson and an assistant photograph ostracode specimens on a Scanning Electron Microscope. This is one of the first steps in the procedure to analyze these microscopic creatures using the 4052.

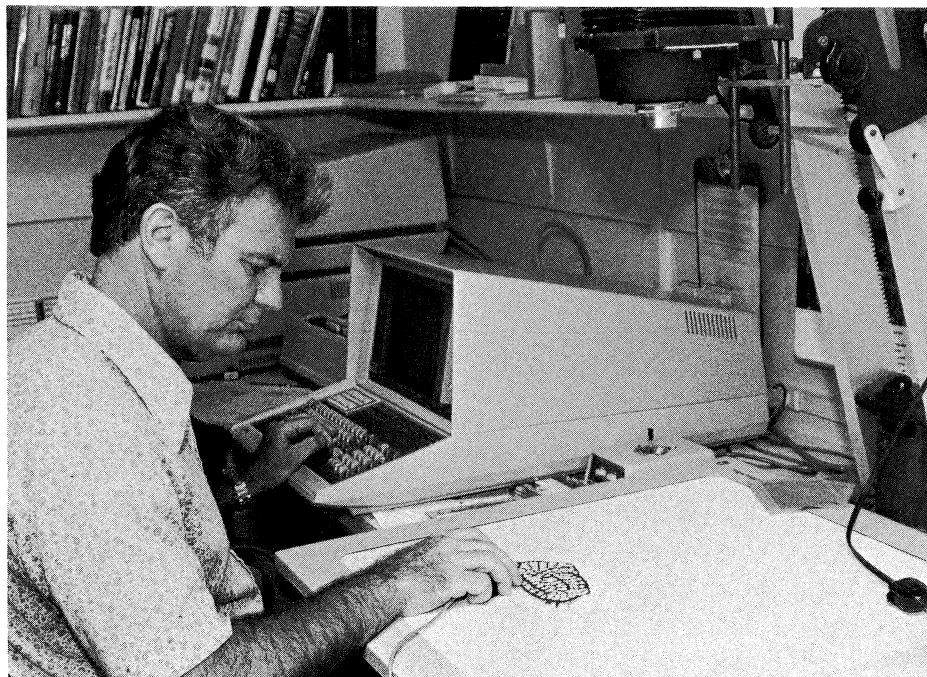

Fig. 3. Although an enlarger is usually used to project the ostracode image onto the tablet, here Dr. Benson is digitizing from a drawing.

analysis of the shape changes alone, although an impressive 26-fold speed increase over the old system has been recorded in this area already. But in addition, the graphic computations will be used to help link the forms together in a probable evolutionary string as well.

One area of particular interest is an area of the Southern Atlantic where two major ridge systems, the Walvis Ridge and the Rio Grande Rise, separate South America from Africa. They serve as huge gates to separate the Atlantic Ocean from the waters of the rest of the world. The history of these gates, letting water come and go as South America split away from Africa, reveals clues about the formation of the present Atlantic circulatory systems. And a lot of that information can be obtained by studying the history of such small crustaceans as the Ostracoda, comparing their distribution in that past to that of today, as well as analyzing their structures.

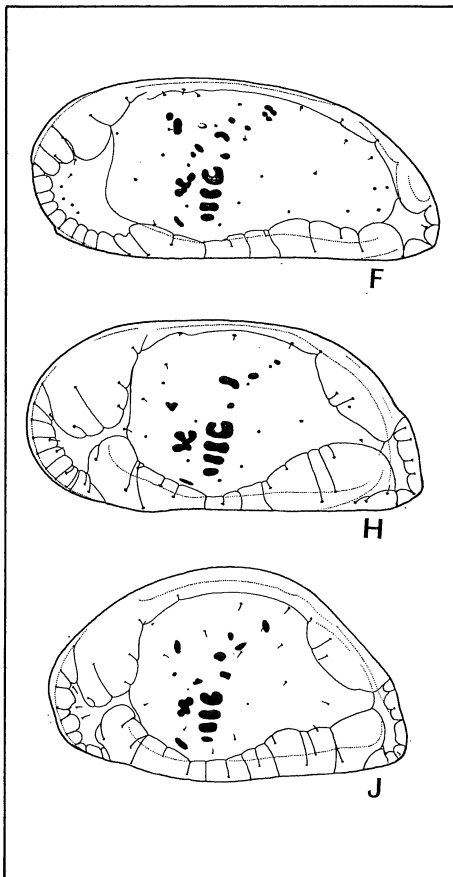



Fig. 4a. H and J are two deep-sea ostracode species living in the Atlantic and Indian oceans. The vectors indicate the relative movement of the 26 points (normal pore canals) used to statistically transform and register one form on the other.

Putting the Information to Work

While it is always important to understand history for its own sake, there are often "practical" reasons as well. Dr. Benson (and other researchers) hope that a realistic restructuring of the ocean's ecosystem may influence exploration for natural resources. These small animals, after all, reflect the total development of the biology of the seas, and it is this biology that is the source of fossil-based energy reserves. Information from this research could influence decisions on where resources are likely or not likely to be found.

While their 4052 work is just getting started, this application is typical of many 4050 Series Graphic Computing Systems. In research environments on the leading edge of today's discoveries, or conveying those discoveries through graphic means, the 4050 Series Graphic Computing Systems are equally at home. 

Photographs courtesy of Smithsonian Institution; Museum of Natural History.

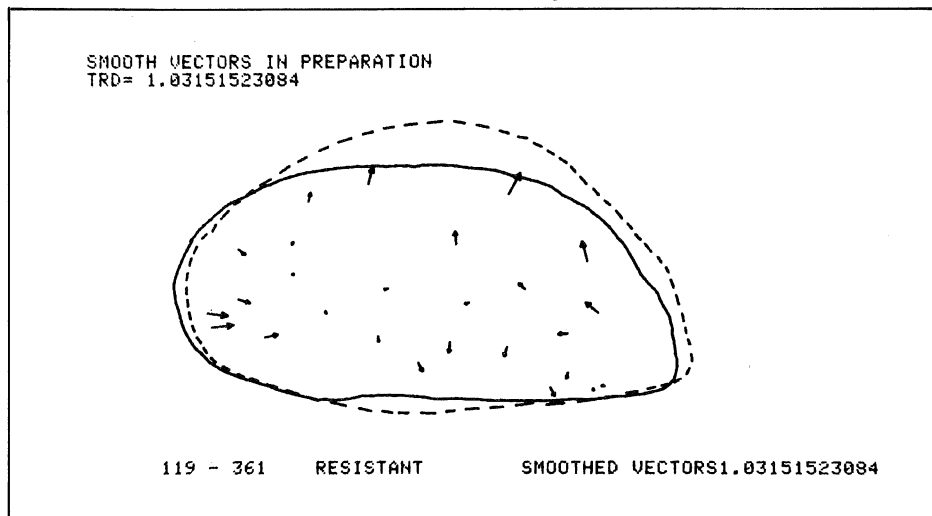

Fig. 4b. The product of the 4052 program illustrates a match of the drawings (outlines) of H and J.

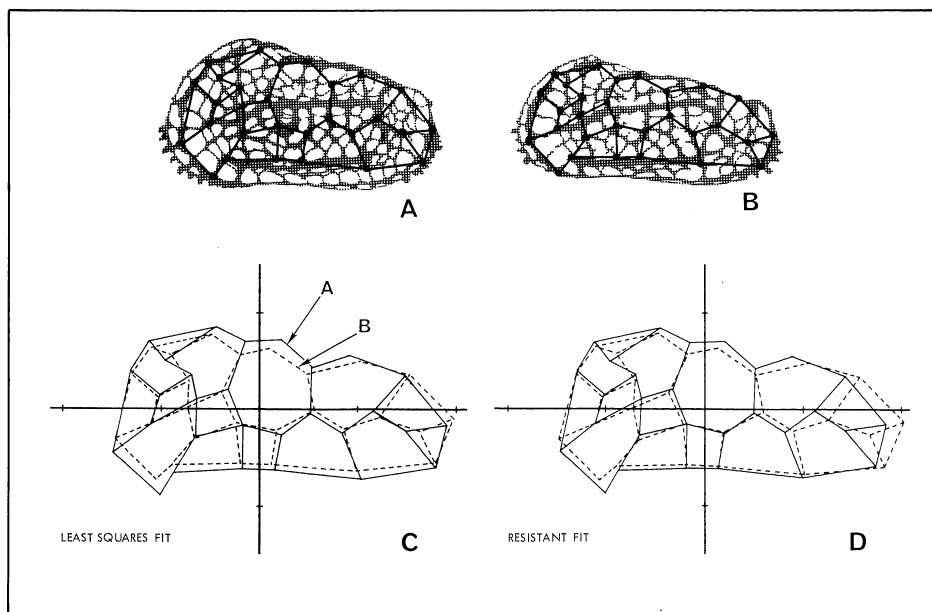

Fig. 4c. A similar problem has been worked out in matching A and B (male and female of a living species from the Channel Islands off France) by two different statistical methods. It shows the superiority of the resistant fit method, a method developed here.

Expanding Your Measurement Capabilities: Introducing the 468 Storage Oscilloscope

by Pat Adamosky
Tektronix, Inc.
Beaverton, OR

The latest addition to the line of portable oscilloscopes from Tektronix, the 468, adds a new dimension to 4050 Series data acquisition and analysis. By combining digital storage and the GPIB interface with portability, measurement flexibility is greatly enhanced.

In the past, some oscilloscopes have used storage CRT's¹ to "freeze" the waveform for a visual analysis of single-shot events. But until recently, the only method for permanent signal storage has been to photograph the display with a camera. Now with low-cost semiconductor memory available, it's possible to store waveforms digitally for either permanent records or signal/signature analysis. The 468 does just this. Although basically a standard 100 MHz portable oscilloscope, it has one major difference. Besides acquiring and displaying the waveforms in real time on a CRT, it also will store the information in digital memory. The stored digitized information may then be displayed on the CRT at any time for analysis or comparison. Because the information captured is in binary form, it's easily transmitted from the 468. Thus, through the GPIB (IEEE-488) interface, a 4050 desktop computer can acquire, process, analyze and graphically display the signal information. And not only is waveform data available, but also all necessary parameters such as amplitude and timing.

¹ Storage CRT's (cathode ray tubes) continue to display a waveform after the input signal ceases. The period of image retention runs from a few seconds to several hours depending on several factors.

² One of the high-performance TEKTRONIX 400 Series model portable oscilloscopes. Its technological advancements, trace quality and operator flexibility have made it the industry standard in oscilloscopes.

The 468 design is based on the widely-used TEKTRONIX 465B real time oscilloscope.² In the non-store mode, the 468 is a conventional oscilloscope that operates just like the 100 MHz 465B. The big difference comes when a STORAGE mode is selected. Then the trace displayed is constructed from the information contained in the digital memory. In the NORM mode, the 468 continually updates the display with the new information acquired at each sweep. The ENVELOPE mode operates similarly to the NORM mode, but it remembers and displays the extremes traversed by the waveform during a selected number of sweeps. An optional AVERAGE mode removes random noise from the signal, and thus improves accuracy.

When you add a 4050 desktop computer to a 468 oscilloscope, you have an extremely powerful and versatile combination. A digitized waveform can now be analyzed mathematically, and the data stored permanently on hard copy or disk or tape. The applications for this system are numerous, and limited only by the imagination of the user.

An example of one possible application is engine analysis. A user could carry his 468

oscilloscope and a 4924 Tape Drive to the site of an industrial engine installation. Once there, he could measure waveforms from transducers mounted on the engine and transfer the waveform data to the magnetic tape in the 4924, through the GPIB. The tape could then be brought back to the lab, and the data transferred to the 4050 system. The 4050 could compare this information against measurements taken at an earlier date and plot long-term changes in readings, indicating possible engine wear.

The 468 is designed for applications requiring a portable instrument that combines standard scope performance with digital storage. It provides the benefits of digital storage while retaining the conventional measurement capability and operating ease of the 465B. The logging and processing of signal data through the optional GPIB makes the 468 one of the most versatile, portable oscilloscopes available today.

For more information on the 468 Storage Oscilloscope, contact your local Tektronix Sales Engineer. 

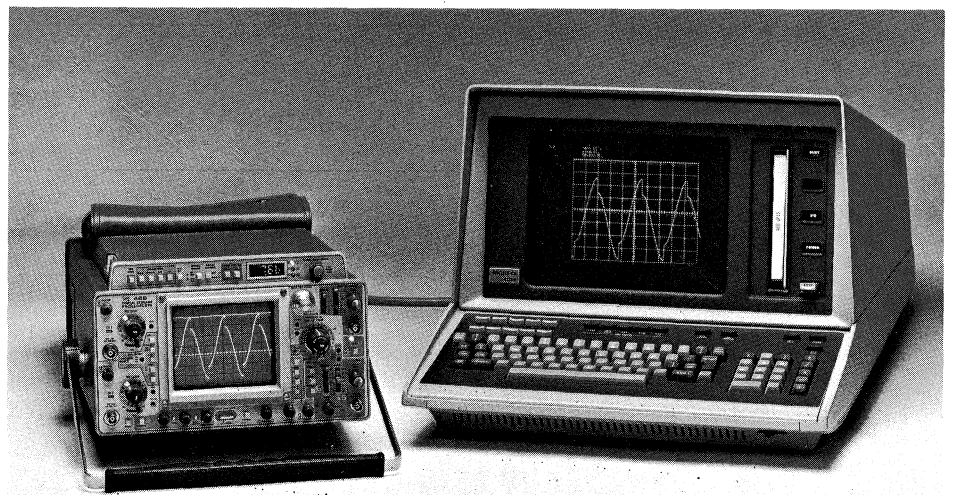

The 4050 Series interfaces with the new TEKTRONIX 468 storage oscilloscope for flexible data acquisition and analysis.

Getting the Best Possible Copies from your 4631 Hard Copy Unit

by Terry Davis
 TEKniques staff
 with George Kusiowski
 and Cathy Cramer
 Tektronix, Inc.
 Wilsonville, OR.

If your system includes a TEKTRONIX 4631 Hard Copy Unit, you may want to optimize the quality of your copies. Perhaps you'd like crisper lines. Or you might want a little more contrast. And at the same time, if you're like most of us, you don't know what adjustments you can make, or even should make. In fact, hard copies might seem a little like magic. Well, they're not magic at all. Let's take a look at some of the adjustments and considerations that can make the best possible copies.

How Copies Are Made

Understanding the technology that makes hard copies possible is a good starting point. Just how does the 4631 capture and copy information written on your display? It's essentially a photographic process, with both exposure and development taking place within the 4631. (Fig. 1). To get the image to the photographic paper, information is picked off the 4050 display by scanning the display with an electron beam, which creates a signal to send to the hard copy unit. The signal tells the hard copy unit when to turn on its own special crt gun to duplicate the narrow image seen by the scanning beam as it moves across the display. A special fiber-optic faceplate focuses the narrow hard copy "display" onto the paper surface; the narrow band of display changes simultaneously with the movement of the photosensitive paper past the crt face.

Since the hard copy unit crt duplicates the 4050 Series display as the paper passes in front of it, the paper is exposed to the same image that was on the display. The exposed paper is then developed by passing it through a heated processor. As the paper is heated, the points exposed to the light from the hard copy unit crt turn dark; unexposed areas remain white. This

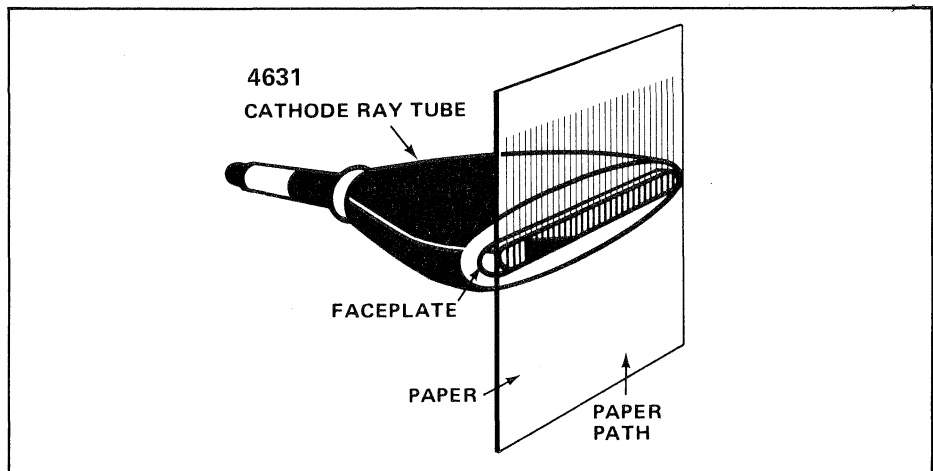
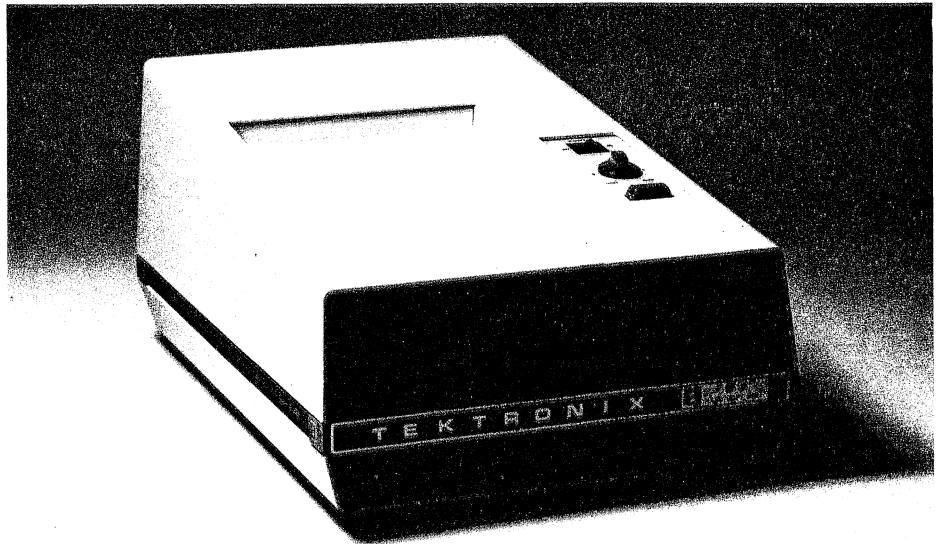

Fig. 1a. Paper path across 4631 CRT faceplate.

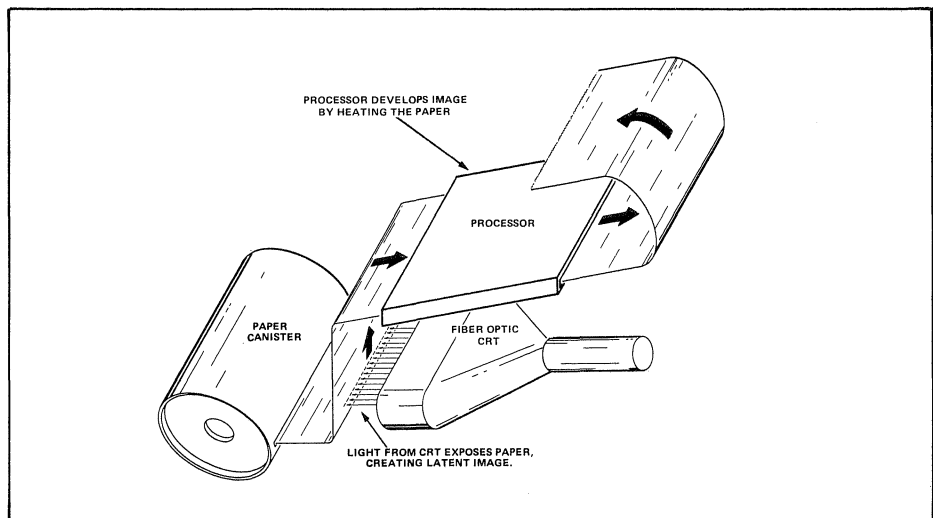

Fig. 1b. 4631 operation.

type of photographic process has several advantages. It's clean and dry, and requires no addition of liquids, toners or other materials to develop the image. Light and heat are the only requirements. In addition, the photographic process offers a very high image quality, and a more faithful reproduction of your display than that offered by other processes.

With that understanding, let's look at several factors which contribute to copy quality, and steps you can take to optimize your hard copies.

Adjusting for Optimum Copies

Within the hard copy unit, three elements influencing copy quality are crt beam intensity, development temperature, and crt beam focus. Factors outside the copier are the level of the hard copy scan on your 4050 Series display and how you treat and handle the hard copy paper.

Getting the Best Contrast

The hard copy crt beam intensity and the development temperature govern the background/image contrast.

Adjusting Crt Intensity. The LIGHT-DARK control on the front panel adjusts the gain (intensity) of the writing beam inside the hard copy unit; the beam that exposes the paper to the image. If the beam level is too low, the image may appear faint or even show gaps within letters or lines. If the crt beam intensity is too high, alphanumeric may bleed together. Start with the control set about mid-point and experiment until you obtain optimum character contrast.

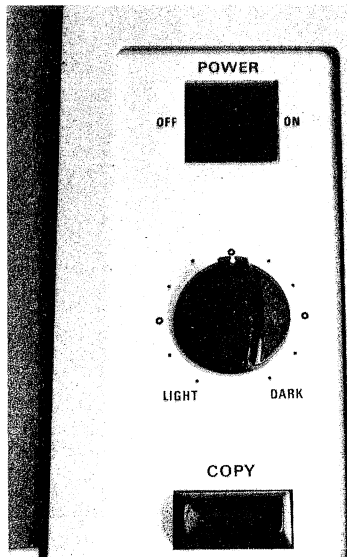

Fig. 2. 4631 Control panel.

Adjusting Development Temperature. The processor temperature controls the development of the exposed paper, and governs the contrast of the developed image. The paper should be developed with the processor as warm as possible while maintaining proper background/image contrast.

Good contrast and sharp lines are gained by setting the processor temperature correctly. If your processor temperature is set too high, the background (white) area of the copy might look grey, perhaps even a little brown. On the other hand, if the processor temperature is set too low, lines will be poorly defined, fuzzy, or grey instead of black.

To adjust the processor temperature, first open the hard copy unit cover and latch it into the upright position. The temperature adjustment is located on the right side of the unit, about halfway back, as shown in Fig. 3. Use a small screwdriver to turn the control: clockwise cools the processor, while counterclockwise warms it.

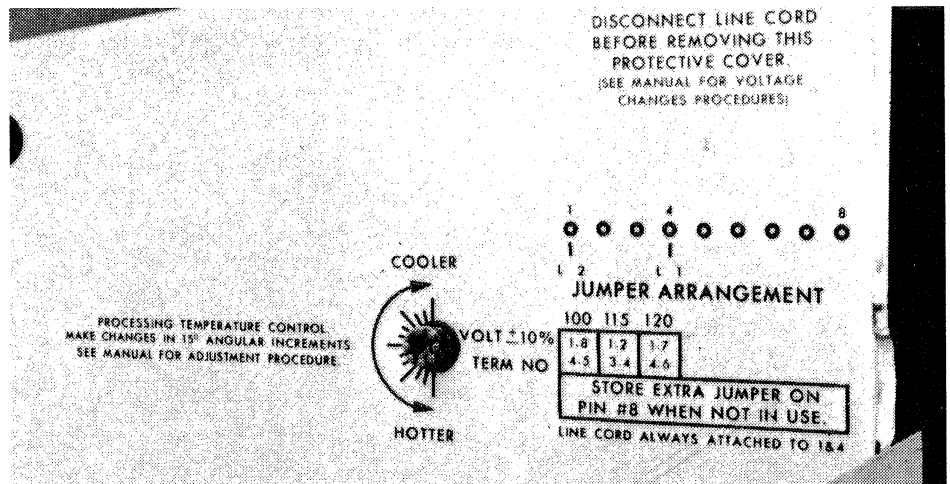

Fig. 3. 4631 Processor temperature control.

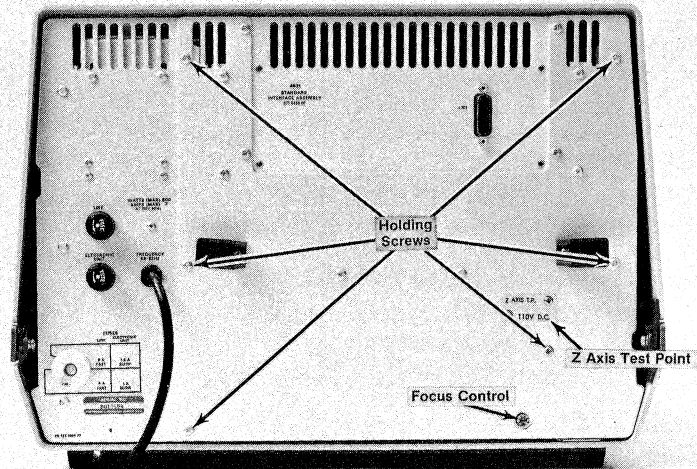

Fig. 4. Focus control on 4631.

Use small steps for adjustment, about 20 degree turns for each step. Then allow time for the processor to adjust to the new setting, and check your copy quality. (The wait time depends on whether your 4631 is already warmed up, or starting cold. If the unit has been warmed up, the processor takes from one to five minutes to change temperatures, depending on the magnitude of the change.

Keep in mind that whenever the cover has been opened, or paper has just been loaded into your unit, the first few inches of paper have been exposed to light. Therefore, when the first copy is run through, that portion of paper exposed to room lighting should be developed to a deep black; if it's grey, the processor is still too cool. For additional checks, you can simply copy a display and check the lines and characters to make certain they're black, and that the background is white.

If the background looks grey when you copy a display, the processor may be too hot. You may need two or three passes at

adjusting back and forth before you zero in on the right processor temperature. When you've found the right setting, lines in the copies should be black, and the background area white. You can use this procedure to obtain ideal copies by matching the temperature to each new batch of paper.

At this point you should return to the LIGHT-DARK control to fine tune the contrast.

Adjusting Image Focus

A number of possible factors can cause copies to be out of focus. If one copy seems fuzzy and the next one seems clear, you may not have properly loaded the paper. Incorrect paper loading can include not threading the paper under the steel idler roll, or not completely inserting the paper cassette holder onto the machine. Either of these can cause the paper to lose contact with the crt faceplate as the paper is exposed, causing the image to be out of focus. If the paper is properly loaded, you may want to work with the *focus adjustment* on the back panel of the 4631 (Fig. 4.).

Before changing the position of the back panel adjustment, use a pencil or a marking pen to mark its present position on the back panel. The mark will be a reference to your starting point, so that you can easily reset the focus to the starting point if you wish to.

Defocused images can have edges that are too soft, or may be softer at the edges of the copy, for instance. The degree of focus you prefer can be somewhat a matter of personal preference. To check focus, fill the screen with one character, such as E's, adjust the LIGHT-DARK Control a bit to the Light side (to help you check the focus in detail) and make a hard copy. The image should be uniform over the whole copy. With the starting position marked, you can try adjusting the focus control to improve the overall image focus. You're through when each character is clearly and uniformly in focus throughout the entire copy. After you've adjusted the focus, make a mark with indelible pen to note the adjustment position.

Adjusting for Best Source Signal

The basis for the hard copy image is the response signal from the 4050 display screen scan; which tells the hard copy unit where to place the image. The adjustment

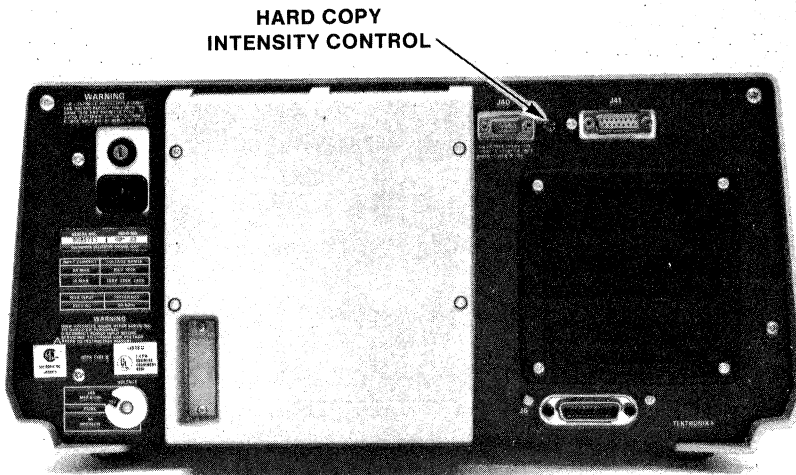

Fig. 5. 4051/4052 hard copy scan intensity control.

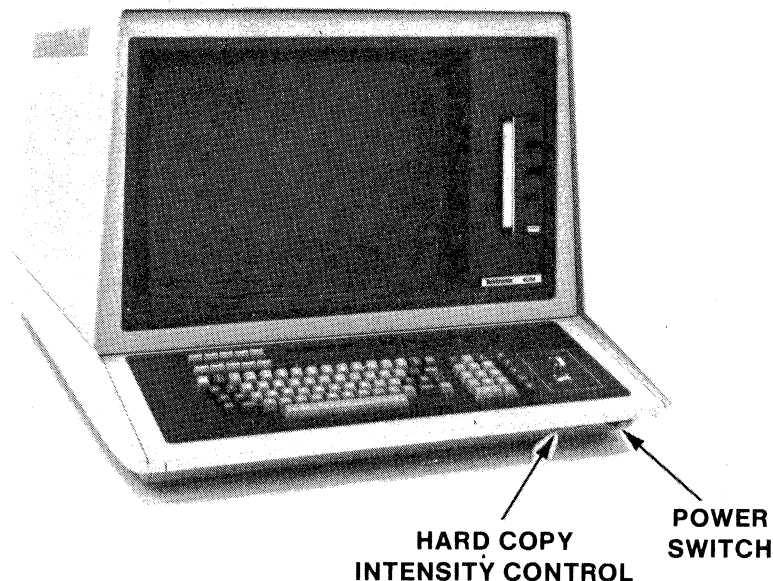

Fig. 6. 4054 hard copy scan intensity control.

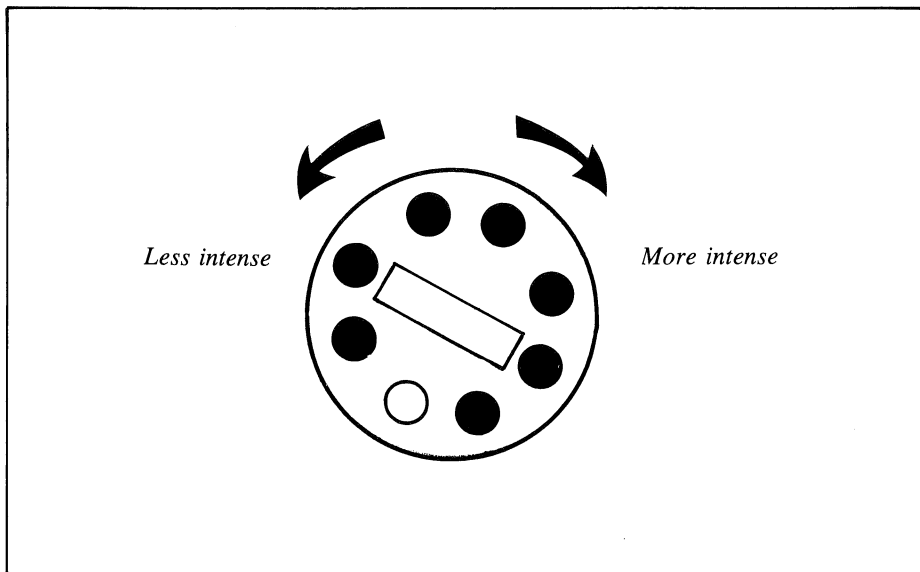

Fig. 7. Direction of the adjustments while facing the hard copy scan intensity control on the 4050 system.

of the storage tube scan can be checked from time to time, to keep copy quality at its best by obtaining the best possible source signal.

The ideal display scan is as intense as possible without storing the scan bar as it crosses the 4050 screen. This adjustment can be made *while* the hard copy scan occurs. The adjustment point is located on the back panel of the 4051 and 4052 (Fig. 5), and directly under the front of the keyboard on the 4054 (Fig. 6).

To adjust the scan intensity, you'll need a small screwdriver. Press the keyboard COPY key to initiate a hard copy, then turn the adjustment as the scan bar crosses the screen. Turn the scan intensity control clockwise until the scan begins to store, then readjust counterclockwise until the bar no longer stores (Fig. 7).

A Look at Paper Handling

One contributing factor in copy quality is the way hard copy paper is treated. Since the paper is developed by exposing it to heat, premature exposure to high heat can change the sensitivity of the paper, thus affecting copy quality. Unopened paper cannisters can last a year stored at 78 degrees F (26 degrees C), without significant change in the paper's sensitivity. And it will last longer when stored at cooler temperatures, just like ordinary photographic film.

Unopened cans should be protected from direct light as well as extreme heat. Once a cannister is opened, light can enter through the paper slot exposing the paper inside the cannister. It's a good idea to store an opened cannister in a desk drawer or filing cabinet where it won't see light. If it's going to be stored for a longer period, take time to seal the paper slot with some opaque tape. (If you make sure to leave a strip of paper showing, the paper will be easy to put back into use.)

Some users refrigerate or freeze unopened paper cannisters to further extend paper life. If you refrigerate the paper, you should allow it about four hours to come up to room temperature before using it. If you freeze it, allow about eight hours.

Of course, handling is important when loading paper into the hard copy unit as well. Once the cannister seal is broken, you should load the paper directly into the hard copy unit to prevent light from entering the cannister and exposing part of the paper.

Maintenance

There are also a few items of routine maintenance that can improve the performance of your hard copy unit. Cleaning is, of course, the most obvious and can be important to your copy quality. When you change paper, you can

take a quick look at the general paper holding area and the crt face (Fig. 8) to make certain they're clean. The cleaner the faceplate of the crt, the clearer your copy will be. Use a rag moistened with soapy water solution. Just remember: don't ever clean the unit with the power on. Turn off the power and unplug the hard copy unit before cleaning. You can check the 4631 Hard Copy Unit Manual for more details on routine maintenance and cleaning.

As you can see, the magic in obtaining good hard copies is the proper adjustment or treatment of the components which combine to make those copies: the hard copy unit's crt beam, its development processor, the 4050 display scan, and the hard copy paper. Although your hard copy unit may never need tuning, understanding the process will help you make the correct adjustments if it ever does. 

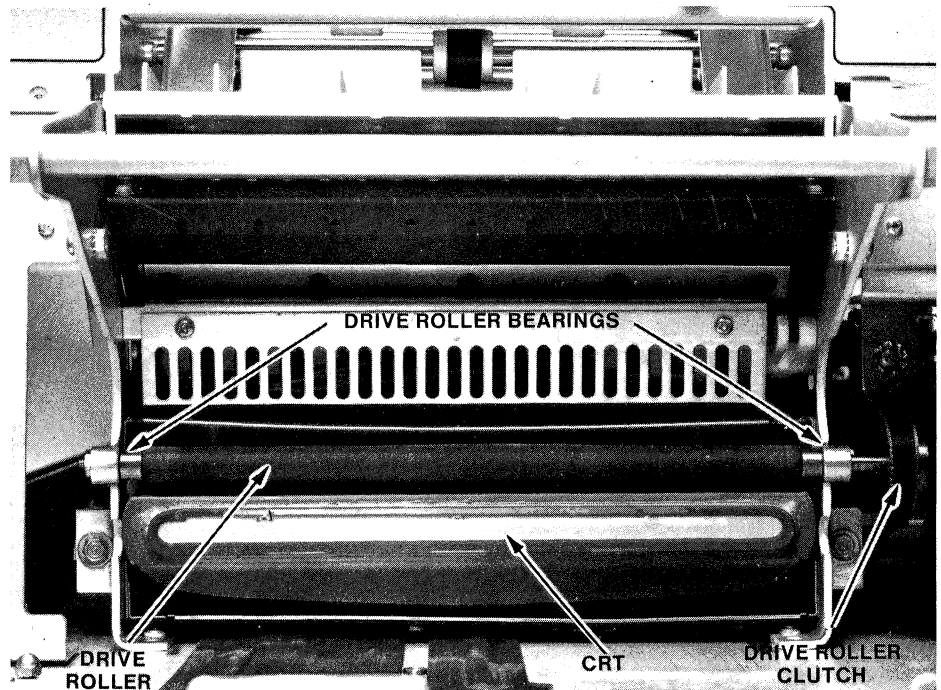
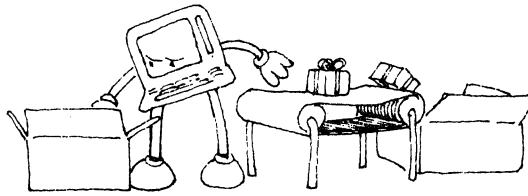

Fig. 8. 4631 CRT faceplate behind cassette.

INPUT / OUTPUT



W.B. Reid, Ph.D., F.C.C.P.M., who is Senior Physicist at the Saskatoon Cancer Clinic at University Hospital in Saskatoon, Canada writes:

I wish to congratulate you on your publication of Reprints (Programming Tips) from the 4050 Series Application Library Newsletter *TEKniques*. I find this a rather very useful form of many programming hints.

I was especially glad to have the sorting algorithms illustrated on pages 21, 85, 94 and 104 brought to my attention, for I had somehow overlooked the quicker sort, which is used in two of these. I wonder if you could supply me with any further references as to the origin of this algorithm.

Dan Taylor, Design Engineer at Tektronix, Wilsonville, responds:

The quicker sort is R.S. Scowen's sorting method based on bisection and recursion. See: Scowen, R.S., "Algorithm 271, Quicksort," *Communication ACM*, Vol. 8, #11, Nov., 1965, pp. 669-670. See also: Loeser, Rudolf, "Some Performance Tests of 'Quicksort' and Descendants," *Communication ACM*, Vol. 17, #3, Mar., 1974, pp. 143-152.

Are there any 4050 users who are interfaced to a PRIME 550 host? This query comes from **Dave Elliott, P.E., Chief Design Engineer at Wood Bros. Homes in Denver.**

If you'd like to talk to Dave, or other 4050-PRIME users, please drop a note to *TEKniques* (address on page 2).

Wrong Caption, Wrong Photo

The correct caption to Fig. 4 in the article, "4051 Aids in Study of Radioactive Elements" published in *TEKniques* Vol. 4 No. 4 should read.

Fig. 4. Input to collect spectral data.

The correct photo for Fig. 4 in the article "On-Line Calorimetry Data Acquisition and Analysis" published in *TEKniques* Vol. 4 No. 5 is shown here.

Our apologies to the authors of these articles.



Fig. 4. Dr. D.L. Raschella at work with the Microcalorimetry facility and the 4051 system. (Courtesy University of Tennessee.)

New Contest to Stir Your Innovative Juices

Combine your creativity with your programming skills: enter TEKniques' **In-Depth Graphing** contest. Two categories provide a wide scope for your imagination.

Categories - 2-D and 3-D

2-D Graphing with Shading

Graphing routines in which the displayed bars, lines, pies, etc., are enhanced to simulate a third dimension. See the example in Figure 1.

3-D Graphing

Graphing routines in which three variables are actually plotted on X, Y and Z axes. See the example in Figure 2.

Rules - Brief and Simple

- It must run on a 4050 Series Desktop Computer.
- Your entry must contain the program on tape or disk, the documentation, and a completed signed Submittal Form.
- More than one program may be contributed.
- A program may be entered into one category only.
- Winners will be chosen by the TEKniques staff.

Awards - Tapes or Disks

Exchange - 3 for 1

Whether you're a winner or not, you'll receive your choice of three programs from the 4050 Applications Library in exchange for each entry. So, you really can't lose.

Deadline - Spring

While away those winter hours on your 4050 System. The entry deadline is March 31, 1981.

Forms - Guidelines, Documentation and such

If you need documentation guidelines, documentation forms, submittal forms, or an order form on which to indicate your

	2-D Graphing	3-D Graphing
First Place	5 boxes of tapes (25) or 5 boxes of disks (50) or a mix of the two	5 boxes of tapes (25) or 5 boxes of disks (50) or a mix of the two
Second Place	3 boxes of tapes (15) or 3 boxes of disks (30) or a mix of the two	3 boxes of tapes (15) or 3 boxes of disks (30) or a mix of the two
Third Place	2 boxes of tapes (10) or 2 boxes of disks (20) or a mix of the two	2 boxes of tapes (10) or 2 boxes of disks (20) or a mix of the two

exchange choices, contact your local library (see the Library Address in each TEKniques).

Start Thinking - Start Coding

How could you present data—business, scientific, or other, in an imaginative

informative, appealing graph? Put your thoughts into code, document them, and send it all in; it could win you and your company a goodly supply of tapes/disks.

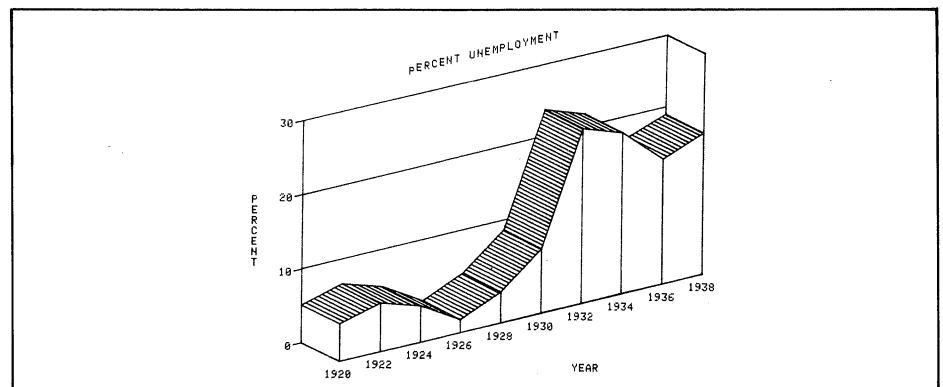

Fig. 1. 2-D category includes data graphed in two dimensions but enhanced by shading such as the bar chart above.

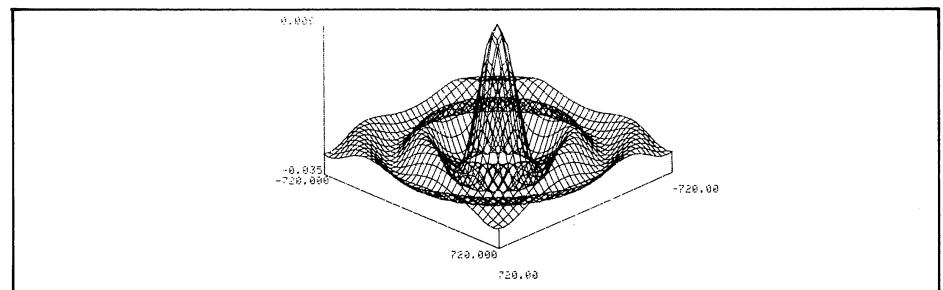

Fig. 2. 3-D category includes data graphed in three dimensions such as the $SIN X/X$ function above or the bar chart shown in the 1980 4050 Series Applications Library Catalog for Abstract #51100-950610.

Editor's Note



New Year to Bring New Library Prices

It's been 17 months since 4050 Series Applications Library prices were changed. Beginning January 1, 1981, the following prices will be in effect:

Documentation & Listing only.....	\$25
Documentation, Listing & Recording Fee.....	30
Cartridge Tape	36
Flexible Disk.....	15

The increase will apply to all orders received after January 1, 1981.

Shutdown Coming

The 4050 Applications Library will shut down operations for one week November 24 through November 28, and for two weeks December 22 through January 2. If you have orders you wish filled before the end of the year, keep these shutdown times in mind.

1980 Catalog Contains Part Numbers

Have you noticed that the 1980 4050 Series Applications Library Catalog contains the part numbers for TEKTRONIX peripherals, software and accessories which complement the 4050 series? This is in addition to the abstracts detailing the 192 programs in the Library and the keyword index. If you don't have your copy of the catalog, please drop us a line or call us. They're free for the asking.

More Telephone Notes

A new feature has been added to the Tektronix Wilsonville telephone system: Direct Inward Dialing. This means if

you're calling from outside Tektronix, you can reach your party directly (without switchboard assistance) by dialing (503) 685-plus extension. For example, to call the 4050 Series Application Librarian, dial (503) 685-3618. To call TEKniques editors, dial (503) 685-3607 or (503) 685-3617.

New Contest Challenges Creativity

Check the page detailing the latest contest. In-Depth Graphing is the theme to draw forth your artistic and ingenious talents. A supply of tapes/disks is the reward.

Input/Output Would Like to Hear From You

Whatever questions you have, large or small, concerning the 4050 Series Applications Library, TEKniques, or anything associated with your 4050 use, will be printed and answered (when possible) in the Input/Output column. Let us hear from you.

Don't get left out: Applications and Tips

Are you missing TEKniques issues? Any of the six from Volume 4 are available by calling or writing the Applications Library serving your area. But those from Vol 1 through 3 have metamorphosed into Application Reprints and Programming Tips. Currently, there are five sets of Application Reprints available, in the following categories:

Engineering & Design	AX-4449
Mapping	AX-4460
Data Acquisition & Analysis ..	AX4450
Business Graphing & Reporting	AX-4451
Peripherals & ROM Packs	AX4452

If you need an article from one of these volumes, a reprint set may fill your needs. To obtain a copy, just contact your local Tektronix office or the Applications Library serving you.

Programming Tips collects 148 tips from the three Volumes into one nifty handbook. A useful keyword index helps you find your subject. The handbook is available through the 4050 Series Applications Library. U.S. domestic price is \$10.

If You Need More Than One

Do you need more than one copy of TEKniques on hand—for students, occasional users, or others? Just let us know how many you'd like to receive at each publication. Call 503-685-3618.

FLASH — FLASH

Watch: SPORTS SPECTACULAR — CBS — November 29, 1980
10th Biennial World Aerobic Championships Oshkosh, Wisconsin

Why? TEKniques Vol 4 No. 8 (December 15, 1980) will give you a behind-the-scenes look at the 4054/Enterprise Radar team at "Olympics of the Air" competition.



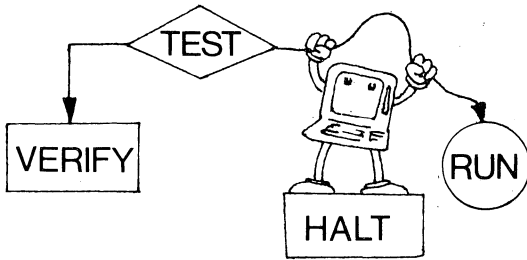

PROGRAMMING TIPS

Understanding the Pie Chart

by Nathan Oxhandler
Tektronix, Inc.
Vancouver, B.C.

Both PLOT 50 and the 4050 Series Applications Library programs contain many pie chart routines. Sometimes you might like to integrate such a routine as part of a complete program package, or modify one to meet a specific need. To do this, you must understand the basic workings of a pie chart routine.

The Pie Outline

First you need to draw a circle which outlines the pie. From basic math we know the sine and cosine values of an angle range from minus one to plus one (-1 to +1). Thus, using the SINE and COSINE functions to obtain the coordinates, you can draw a circle which has a radius of one unit in a square window in a square viewport on the screen.

The window should be slightly larger than the size of the circle to leave some labeling room around the pie. WINDOW -1.5, 1.5, -1.5, 1.5. Of course, the center of the circle is 0,0 with a radius of 1.

The viewport of the 4050 Series and the 4663 Plotter is 130 by 100 graphic display units. The viewport of the 4662 Plotter is 150 by 100 graphic display units. A square viewport that will center the pie in the window for the 4050 and 4663 is VIEWPORT 15, 115, 0, 100. For the 4050 and 4662, the command is VIEWPORT 15 + 10*(D=1), 115 + 10*(D=), 0, 100, where D is the variable for the device address and the address for the 4662 is 1.

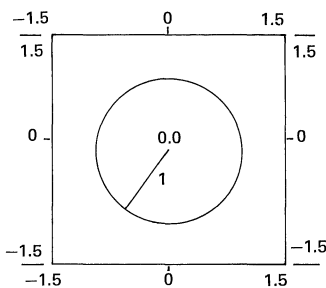

The following routine draws a circle in a clockwise direction. The STEP command saves time when previewing a pie chart on the 4051.

```

1 INIT
2 D=32
100 REM Program #1
110 VIEWPORT 15+10*(D=1),115+10*(D=1),0,100
120 WINDOW -1.5,1.5,-1.5,1.5
130 SET DEGREES
140 REM MOVE TO START POINT
150 MOVE @D:0,1
160 REM DRAW CIRCLE
170 FOR I=0 TO 360 STEP 1+9*(RND(0)<=0.5)*(D=32)
180 DRAW @D:SIN(I),COS(I)
190 NEXT I
200 END
  
```

The Pie Segments

Now let's look at some practical limitations of the pie chart. If any of the data items is going to be less than 1% of the total, or if a large number of small percentage data items exist, or if the total number of segments exceed 15 to 20, you should consider a bar chart or line chart. Otherwise you could run into visual definition problems. If possible, mix small and large segments for easier labeling. With these limits in mind, let's look at some data.

ITEM #	DATA	PERCENT	DEGREES	CUMULATIVE
1	1.0	10	36.0	36.0
2	2.4	24	86.4	122.4
3	2.6	26	93.6	216.0
4	4.0	40	144.0	360.0
TOTAL	10.0	100	360.0	

Since a circle has 360 degrees, each 1% of data is represented by 3.6 degrees (360/100). Therefore, multiply the data percentage by 3.6 to obtain its representation in degrees; i.e., 24*3.6=86.4.

To draw the radius of the first segment, move to the center of the circle, calculate the data in degrees, and draw to the SINE and COSINE coordinates of the angle.

```

300 MOVE 0,0
310 DRAW @D:SIN(1/10*360),COS(1/10*360)
  
```

To draw the radius of the next segment, you'll need to create a cumulative total.

```

1000 MOVE 0,0
1010 DRAW @D:SIN((1+2.4)/10*360),COS((1+2.4)/10*360)
  
```

A practical program for this pie chart using one data array follows.

```

1 INIT
2 D=32
100 REM Program #1
110 VIEWPORT 15+10*(D=1),115+10*(D=1),0,100
120 WINDOW -1.5,1.5,-1.5,1.5
130 SET DEGREES
140 REM GET DATA, N=NUMBER OF POINTS IN ARRAY D1
150 PRINT "HOW MANY SEGMENTS?I#:"
160 INPUT N
170 DELETE D1
180 DIM D1(N)
190 FOR I=1 TO N
200 PRINT "SEGMENT #";I;"IDATA1:";
210 INPUT D1(I)
220 NEXT I
230 REM T=TOTAL OF ARRAY D1
240 T=SUM(D1)
250 PAGE
260 REM DRAW CIRCLE
270 MOVE @D:0,1
280 FOR I=0 TO 360 STEP 1+9*(RND(0)<=0.5)*(D=32)
290 DRAW @D:SIN(I),COS(I)
300 NEXT I
310 REM DRAW RADIUS, D2=CUMULATIVE DATA
320 D2=0
330 FOR I=1 TO N
340 D2=D2+D1(I)
350 MOVE @D:0,0
360 DRAW @D:SIN(D2/T*360),COS(D2/T*360)
370 NEXT I
380 END
  
```

Compare statement 360 with the DRAW commands in the two preceding examples.

Run the preceding program.

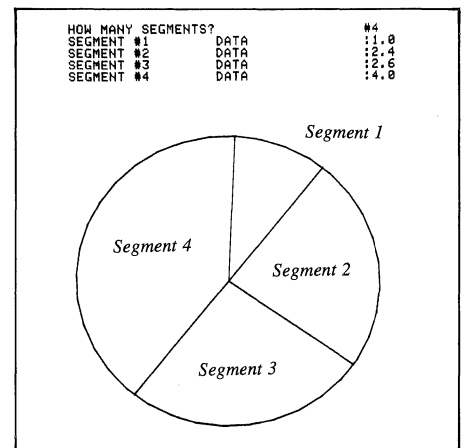

Exploding the Segments

One desirable enhancement for a pie chart is highlighting or exploding a segment. However, this would not be practical using a solid circle as the outline. Therefore, draw a radius and its arc as a separate subroutine and add an offset. Using the previous data, let's explode the first segment by moving it out from the center of the circle at 1/10 the radius and away from both adjoining segments equally. Statement 310 controls the length of the arc.

To do this, halve the data and calculate the resulting value in degrees (statement 270); take one-tenth of that value and store it in variables X and Y (statements 280-290); move to the offset (statement 300), and draw to the respective SIN and COS coordinates, plus the offset, of the data (statement 320). Statement 340 allows for non-integer degrees so the segment will be complete.

```

270 A=1/2*10*360
280 X=SIN(A)/10
290 Y=COS(A)/10
300 MOVE @D:X,Y
310 FOR I=0 TO 1/10*360
320 DRAW @D:X+SIN(I),Y+COS(I)
330 NEXT I
340 DRAW @D:X+SIN(1/10*360),Y+COS(1/10*360)
350 DRAW @D:X,Y
    
```

To explode the next segment, you'll have to include the cumulative total in statements 270, 310, and 340.

```

270 A=(1+2.4/2)/10*360
280 X=SIN(A)/10
290 Y=COS(A)/10
300 MOVE @D:X,Y
310 FOR I=1/10*360 TO (1+2.4)/10*360
320 DRAW @D:X+SIN(I),Y+COS(I)
330 NEXT I
340 DRAW @D:X+SIN((1+2.4)/10*360),Y+COS((1+2.4)/10*360)
350 DRAW @D:X,Y
    
```

To optimize the exploding capability, let the user choose the segment he wishes to explode. Keep track of this information as part of the data array by setting the data point of the exploded segment to a negative number. Branch to the appropriate program lines based upon the sign of the data.

```

1 INIT
2 D=32
100 REM PROGRAM #2
110 UTEMPT 15+10*(D=1),115+10*(D=1),0,100
120 WINDOW -1,5,1,5,1,5,1,5
130 SET DEGREES
140 REM SET DATA, N=NUMBER OF POINTS IN ARRAY
150 REM D1=DATA ARRAY, T=SUM OF D
160 PRINT "HOW MANY SEGMENTS?I#:"
170 INPUT I
180 DELETE D1
190 DIM D1(N)
200 FOR I=1 TO N
210 PRINT "SEGMENT #I:IDATAI:"
220 INPUT D1(I)
230 NEXT I
240 T=SUM(D1)
250 REM FIND WHICH SEGMENTS TO EXPLODE, MAKE D1 NEGATIVE ON Y
270 PRINT "FOR EACH SEGMENT YOU WISH EXPLODED ANSWER 'Y'"
280 PRINT "SEGMENT #IDATAIPERCENTAGEEXPLODE?"
290 IMAGE @D:191,FD,FD,377,3D,2D,*,*,.05T,*,*,2X,S
300 FOR I=1 TO N
310 PRINT USING 290:I,D1(I),D1(I)/T*100
320 INPUT Y$
330 Y=SEG(Y$,I)
340 GO TO Y<>:Y+ OF 360
350 D1(I)=D1(I)*Y
360 NEXT I
370 PAGE
380 REM DRAW SEGMENTS, D2=CUMULATIVE DATA, X AND Y = OFFSET OF A
390 D2=0
400 FOR J=1 TO N
410 X=0
420 Y=0
430 A=D2+ABS(D1(J))/2/T*360
440 GO TO SGN(D1(J))<-1 OF 470
450 X=SIN(A)/10
460 Y=COS(A)/10
470 MOVE @D:X,Y
480 FOR I=D2/T*360 TO (D2+ABS(D1(J)))/T*360
490 DRAW @D:X+SIN(I),Y+COS(I)
500 NEXT I
510 DRAW @D:X+SIN((D2+ABS(D1(J)))/T*360),Y+COS((D2+ABS(D1(J)))/T*360)
520 D2=D2+ABS(D1(J))
530 D2=D2+ABS(D1(J))
540 NEXT J
550 END
    
```

HOW MANY SEGMENTS?	#
SEGMENT #1	DATA 11.0
SEGMENT #2	DATA 12.4
SEGMENT #3	DATA 12.6
SEGMENT #4	DATA 14.0

FOR EACH SEGMENT YOU WISH EXPLODED ANSWER 'Y'	DATA	PERCENTAGE	EXPLODE?
1	2.4	24.00%	? Y
2	2.6	26.00%	? N
3	4.0	40.00%	? N

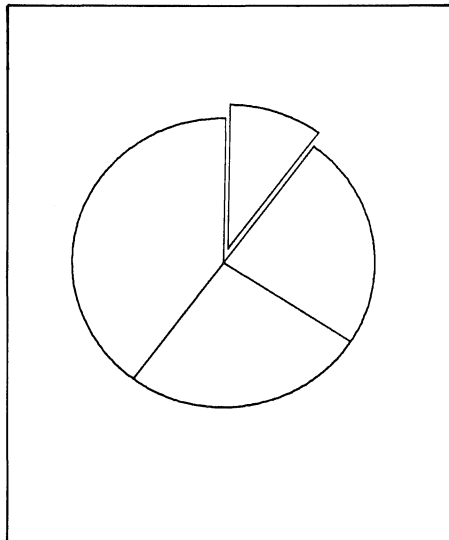

Labeling the Segments

Another enhance adds arrows to the segments for labeling. Include a statement to set ROTATE to 0 prior to any DRAW or MOVE commands (statement 405). Now, add the code for arrows within the segment loop:

```

485 ROTATE 0
530 REM DRAW ARROW
540 RMOVE @D:SIN(A),COS(A)
550 ROTATE @D:A-15
560 RDRAW @D:0,05,0
570 RMOVE @D:-0,05,0
580 ROTATE 90-A+15
590 RDRAW @D:0,05,0
600 RMOVE @D:-0,05,0
610 ROTATE 90-A
620 RDRAW @D:0,1,0
630 GIN @D:Z1,Z
640 DRAW @D:1.2*SGN(SIN(A))+1.2*(SIN(A)=0)-X,Z-Y
    
```

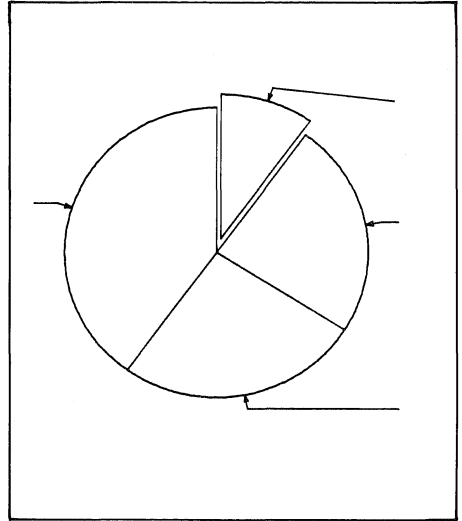

On a 4051 and 4052 this leaves 12 character spaces for labeling. On the 4054 the variable character sizes would allow 24 characters if desired. The following program includes all the steps we've described:

- o Setting the window and viewport
- o Entering Data
- o Labeling the chart and the segments
- o Exploding the segments

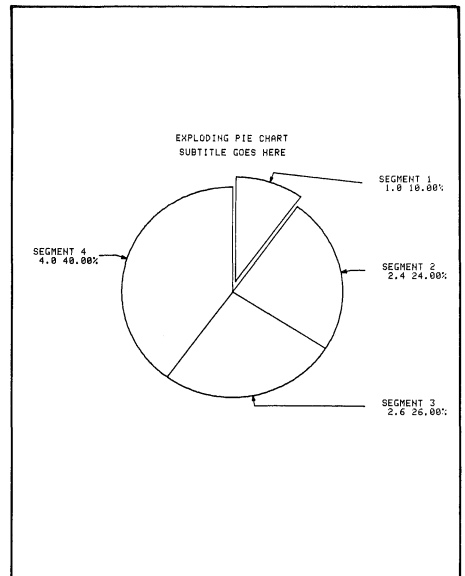

```

1 INIT
3 GO TO 100

100 REM PIE CHART PROGRAM
110 REM D=Output Device Address

120 D=32

130 REM Square Window in a Square Viewport

140 VIEWPORT 15+10*(D=1),115+10*(D=1),0,100
150 WINDOW -1.5,1.5,-1.5,1.5
160 SET DEGREES

170 REM GET DATA, N=Number of Points in Array
180 REM D1=DATA ARRAY, T=SUM OF D
190 REM S$=Segment Titles

200 PRINT "LIEXPLODING PIE CHART ROUTINE..JTITLE FOR CHARTI?"
210 INPUT T$
220 PRINT "SUBTITLEI? ";
230 INPUT U$
240 PRINT "LHOW MANY SEGMENTS?I*";
250 INPUT N
260 DELETE D1,S$
270 DIM D1(N),S$(N*13)
280 S$=""
290 V$=""
300 FOR I=1 TO N*13
310 S$=REP(V$,I,0)
320 NEXT I
330 PRINT "LISEGMENT TITLE"
340 FOR I=1 TO N
350 PRINT "SEGMENT #;I;"IDATAI!";
360 INPUT D1(I)
370 PRINT "KIII <<<<HHHH>>>>..KIII";
380 INPUT V$
390 V$=SEG(V$,1,13)
400 S$=REP(V$,I*13-12,LEN(V$))
410 NEXT I

420 REM T=TOTAL OF ARRAY D1
430 T=SUM(D1)

440 REM FIND WHICH SEGMENTS TO EXPLODE, MAKE D1 NEGATIVE ON Y

450 PRINT "JFOR EACH SEGMENT YOU WISH EXPLODED ANSWER 'Y'"
460 PRINT "JSEGMENT #IDATAIPERCENTAGEIEXPLODE?"
470 IMAGE 4D,19T,FD,FD,37T,3D,2D,"Z",55T,"?",2X,S
480 FOR I=1 TO N
490 PRINT USING 470:I,D1(I),D1(I)/T*100
500 INPUT Y$
510 Y$=SEG(Y$,1,1)
520 GO TO Y$<>'Y' OF 540
530 D1(I)=D1(I)*-1
540 NEXT I
550 PAGE

560 MOVE @D:-0.05376*(LEN(T$)/2),1.44
570 PRINT @D:T$
580 MOVE @D:-0.05276*(LEN(U$)/2),1.3
590 PRINT @D:U$

600 REM DRAW SEGMENTS, D2=CUMULATIVE DATA, X AND Y = OFFSET OF A

610 REM A IS MIDPOINT OF SEGMENT

620 D2=0
630 FOR J=1 TO N
640 ROTATE 0
650 X=0
660 Y=0
670 A=(D2+ABS(D1(J))/2)/T*360
680 GO TO SGN(D1(J))<>-1 OF 710
690 X=SIN(A)/10
700 Y=COS(A)/10
710 MOVE @D:X,Y
720 FOR I=D2/T*360 TO (D2+ABS(D1(J)))/T*360
730 DRAW @D:X+SIN(I),Y+COS(I)
740 NEXT I
750 DRAW @D:X+SIN((D2+ABS(D1(J)))/T*360),Y+COS((D2+ABS(D1(J)))/T*360)

760 DRAW @D:X,Y
770 REM DRAW ARROW

780 RMOVE @D:SIN(A),COS(A)
790 ROTATE 90-A-15
800 RDRAW @D:0.05,0
810 RMOVE @D:-0.05,0
820 ROTATE 90-A+15
830 RDRAW @D:0.05,0
840 RMOVE @D:-0.05,0
850 ROTATE 90-A
860 RDRAW @D:0.1,0
870 GIN @D:Z1,Z
880 DRAW @D:1.2*SGN(SIN(A))+1.2*(SIN(A)=0)-X,Z-Y

890 REM PRI SEGMENT INFORMATION

900 V$=SEG(S$,J*13-12,13)
910 P=POS(V$,"",1)
920 GO TO P=0 OF 960
930 V$=SEG(V$,1,P-1)
940 GO TO SGN(SIN(A))+1 OF 960,960
950 MOVE @D:-1.95,Z-Y
960 GIN @D:Z1,Z
970 W$=SEG(" ",1,7-LEN(V$)/2)
980 V$=REP(W$,1,0)
990 PRINT @D:V$
1000 MOVE @D:Z1,Z-0.08448
1010 IMAGE 5D,1,3D,2D,"Z"
1020 PRINT @D: USING 1010:ABS(D1(J)),ABS(D1(J)/T*100)
1030 ROTATE 0
1040 D2=D2+ABS(D1(J))
1050 NEXT J
1060 END

```

Using Refresh on the 4054

The dynamic graphics of the 4054 offer another advantage. The user could choose which segment he wanted to explode as a starting point, and then continuously explode each individual segment of the pie, one at a time.

```

20 GO TO 1100
40 RUN 550

720 ROPEN J
725 RDRAW @D:SIN(D2/T*360),COS(D2/T*360)
730 REM DRAW SEGMENT
735 FOR I=D2/T*360+1 TO (D2+ABS(D1(J)))/T*360-1
740 RDRAW @D:SIN(I)-SIN(I-1),COS(I)-COS(I-1)
745 NEXT I
750 XI=(D2+ABS(D1(J)))/T*360
755 RDRAW @D:SIN(XI)-SIN(I-1),COS(XI)-COS(I-1)
760 RDRAW @D:-SIN(XI),-COS(XI)

885 RCLOSE

1100 REM ROTATING EXPLODE OF SEGMENTS
1110 FOR J=1 TO 10
1120 D2=0
1130 FOR I=1 TO N
1140 A=D2+ABS(D1(I))/T*360/2
1150 STPOINT I,SIN(A)/10,COS(A)/10
1160 CALL "WAIT",2
1170 D2=D2+ABS(D1(I))/T*360
1180 STPOINT I,0,0
1190 NEXT I
1200 NEXT J
1210 RETURN

```

Statement 20 codes User-Definable Key 5 to begin 4054-enhanced pie chart.

Statement 40 codes User-Definable Key 10 to execute the initial pie chart.

Statements 720-760 and 885 define the pie chart for refresh. Note that relative draws have been substituted in order to work with the STPOINT command.

Statements 1100-1210 execute the rotating, refreshed exploding segments.

This gives you a basic idea of the capabilities and requirements of pie chart routines. You can, of course, enhance it further—editing, data storage, etc.

Credits: I wish to thank Fred Facht of the Social Security Administration whose questions instigated this article, and I wish to thank John Carter, Systems Analyst at Tektronix, for his valuable assistance.

BRIGHTNESS and the 4054

by Mark Mehall

Tektronix, Inc.
Wilsonville, OR

On the 4054 the BRIGHTNESS command can be used to produce wider than normal vectors or brighter than normal characters or both. It may also be used to obtain darker hard copies in applications where high resolution is not critical.

The BRIGHTNESS statement specifies the intensity and focus parameters for the display. The display code definitions are as follows.

Display Code	Intensity	Focus
0	Normal	Defocused
1	Normal	Focused
2	Bright	Defocused
3	Bright	Focused

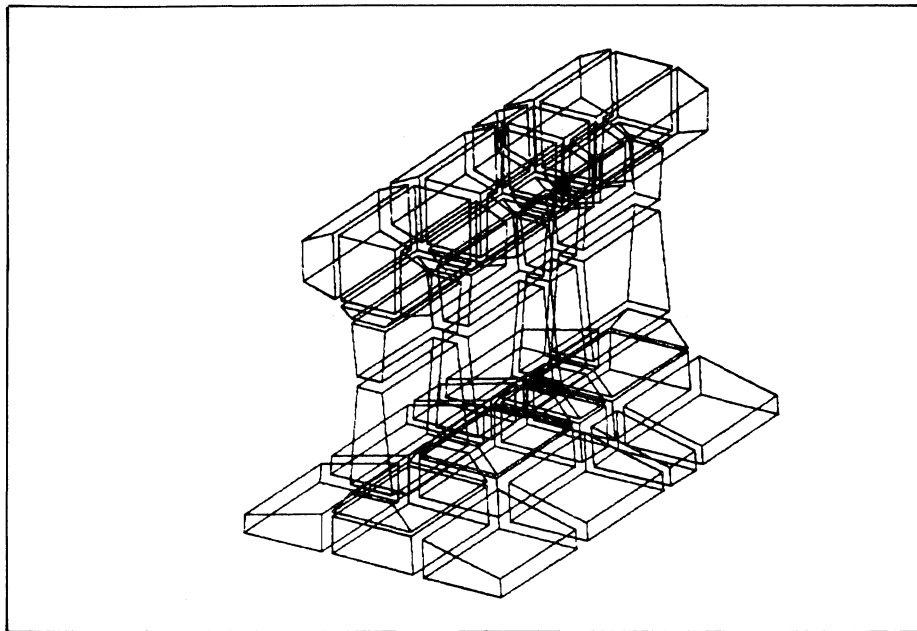

BRI 1 produces high resolution vectors.

Bright intensity increases the displayed intensity of characters and vectors; defocused lines appear wider than focused lines.

The default setting is 1 (normal, focused). This parameter is reset by an INIT command. The default address is PRINT @32,30.

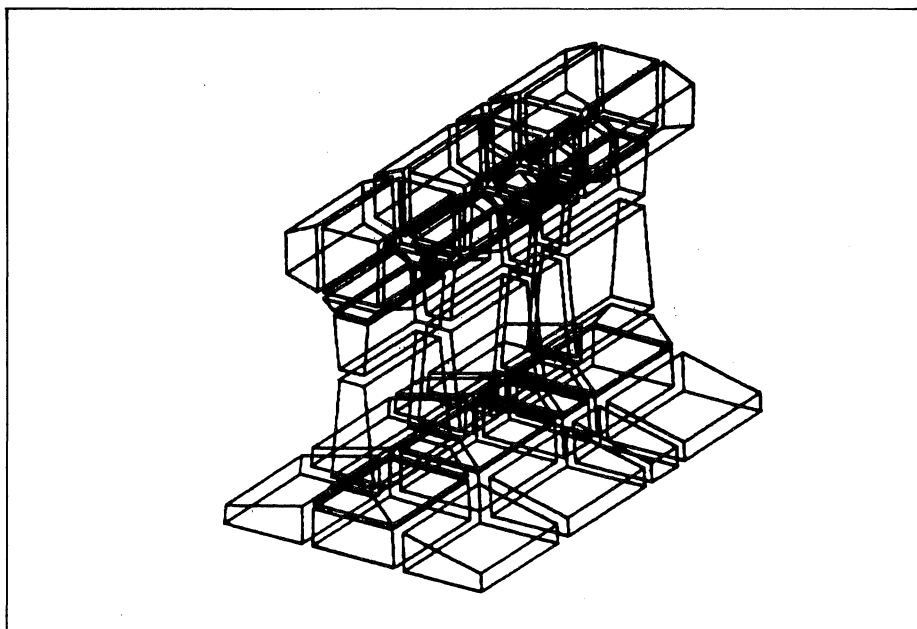

BRI 2 produces thicker vectors which makes the hard copy look darker.

Don't Be Too Hasty to Push the User-Definable Keys

by S.H. Whitlow

Environment Canada
Inland Waters Directorate
Ottawa, Ontario

The features of the PLOT 50 Statistics packages are conveniently driven by pushing the User-Definable Keys indicated by the appropriate overlay. It is important, however, that the operation initiated by pressing a key be allowed to run to completion or else erroneous results may occur in subsequent operations.

Our experience comes from determining the correlation within a set of 75 data points.

With this many points, the best fit and regression calculations require an appreciable amount of time on the 4051. An inexperienced operator may feel the delay is because some action is required from him, or suspect something has gone wrong in the process. In our case, the user pressed other keys to list or plot his data in an attempt to verify his points were still there and to re-establish control. He had unknowingly interrupted the calculations, although this wasn't apparent, and the results, when printed, gave incorrect R-square values since the final summations had not yet been reached. When the calculations were redone allowing sufficient time, the three statistical

packages each produced the identical, correct results.

We have written this tip in the hope that our experience will prove helpful to other users and prevent them reaching incorrect results through premature operator intervention. Since there may be no printout following the completion of a statistical operation, the operator should wait for the "busy light" to go out before starting a new sequence with another User-Definable Key.

Edit Keys Extend 4050 Versatility

by Steve Franck

Tektronix, Inc.
Phoenix, AZ

Every 4050 user has pressed the REPRINT key to get a clean display of the line being entered when it contains overwritten characters and rubouts. But, did you know that if you are not in the process of entering something and you press REPRINT, the last thing you typed in will be magically brought back into the line buffer?

As an example, let's say you key in a type 0 directory for some file identifier on disk, and the 4050 returns with a listing.

```
DIR: "DATABASE"  
DATABASE/ZAP/MASTER/INIT  
DATABASE/ZAP/MASTER/DATA
```

Now you decide you want a type 1 directory. You could retype the line. Instead, press REPRINT key; it will bring the command back into the line buffer and you simply change the 0 to 1, press RETURN and the extended directory listing will be displayed.

```
DIR: "DATABASE"  
DATABASE/ZAP/MASTER/INIT      508 ALLOC 17-OCT-80 01:48 ALT  
B U SC N ATR  
DATABASE/ZAP/MASTER/DATA     26416 ALLOC 17-OCT-80 01:48 ALT  
B R SC N ATR
```

Another example, you try to create a file but get an error because the write protect switch on the 4907 is on.

```
CREATE "DATABASE/ZAP/MASTER/BLIPPO"128,78  
ERROR 11 - DEVICE WRITE PROTECTED - DEVICE ADDRESS 0  
ERROR IN IMMEDIATE LINE - MESSAGE NUMBER 89
```

Turn the switch off, press REPRINT, then RETURN, and your command is re-entered without retyping the whole line.

The REPRINT key works on almost anything except a LIST command; you cannot bring the LIST verb back with the REPRINT key.

Another trick with the editor keys is to use the AUTO NUMBER key to change many lines. If you wanted to change lines 1000, 1010, 1020, 1030, and 1040, for example, you could recall each line individually to make the change. But key in 1000 and press AUTO NUMBER; each line will be brought up one at a time, you make the change, press RETURN, and the next one will come up. Press AUTO NUMBER again when you're through editing all your lines.

A final hint concerns the RECALL NEXT LINE key. Let's say your program aborts due to an undefined variable (or something). You could type LIST to check the code. However, the only way to stop LIST once you've seen what you want, is to press the

BREAK key twice. Unfortunately this ends the program closing files, terminating loops, etc.¹ Instead of typing LIST, enter a statement number and hold down the RECALL NEXT LINE key. Like all keys, this will repeat, causing the program code to be displayed. When you've seen enough, press RETURN. Your list will be aborted without ENDing your program.

¹See "Interrupting a Program" in TEKniques Vol. 3 No. 6, or Programming Tips, page 93.

Honoring SRQ's While Waiting for Keyboard Input

by Phil Somersset
Tektronix, Inc.
Rockville, MD

If you are running a program that must act quickly on SRQ's from external devices, imagine the problems that can arise if an INPUT statement is executed and you are not at the machine. The 4050 senses the SRQ but must complete the INPUT statement before the SRQ Handler Subroutine can be entered.

This method involves putting the program into a tight loop at line 10000 that can be interrupted by an SRQ. At the same time, the user may push UDK #5 to enter data.

Implementing this method takes three steps .

1. Program a UDK (in this example, UDK #5 is programmed),
2. Provide the loop subroutine (here starting at line 10000), and
3. Insert a GOSUB statement preceding every INPUT statement where a delayed input could cause SRQ handling to be missed.

Editors Note: A related solution is contained in the article "New ROM Pack Adds Time Functions to 4052 and 4054" published in TEKniques Vol. 4 No. 6.

UDK PROGRAMMING

```
1 F=1
2 SET KEY
3 GO TO 1000
20 F=0
21 RETURN
```

MAIN PROGRAM

```
1000 REM - INPUT DESIRED HERE...
1010 PRINT "ENTER DATA. ";
1020 GOSUB 10000
1030 INPUT D
1040 REM - PROGRAM CONTINUES...
1050 REM ...
```

HERE IS THE INPUT LOOP

```
10000 PRINT "PUSH UDK #5 AND ENTER DATA: ";
10010 IF F THEN 10010
10020 F=1
10030 RETURN
```

A 4054 Option 30 Simple Input Editor

by Carl W. Dawson
Tektronix, Inc.
Orlando, FL

A 4054 Option 30 Dynamic Graphics Option provides many new tools for the programmer. In particular, use the 4054 Option 30 in concert with the POINTER command to program a simple refreshed input editor. The following listing illustrates such an editor.

The subroutine "ANSWER" prompts a user for input with a refreshed message (Q\$) and accepts a response from the user (A\$). As the user types each character of the response, the answer string is displayed on the screen in refresh. The BACKSPACE or RUBOUT keys may be used to delete individual characters; a control "D" ("D") character deletes the entire response. Pressing RETURN causes the response to be accepted and the refreshed messages to be deleted. A

cursor (the underscore character) indicates the next character position for user input.

To use this subroutine, specify the prompt message in Q\$, specify the coordinates for the beginning of the prompt message in X1 and Y1 (the response appears below the prompt) and define the maximum length of A\$ in variable L1. As mentioned above, the BACKSPACE, RUBOUT, D and RETURN keys perform simple editing.

```
100 INIT
110 DIM A$(20)
120 X1=65
130 Y1=50
140 L1=20
150 Q$="WHAT TIME IS IT ?"
160 GOSUB 1000
170 PAGE
180 PRINT "THE TIME IS ";A$
190 END

1000 REM -----SUBROUTINE ANSWER -----
1010 REM Q$ PROMPT STRING (INPUT)
1020 REM A$ ANSWER STRING (OUTPUT)
1030 REM (X1,Y1) COORDINATE FOR PROMPT
1040 REM L1 MAXIMUM LENGTH OF ANSWER STRING
1050 REM X,Y,Z$,X0,Y0 SCALAR AND STRING WORK VARIABLES
1060 REM SEGMENTS USED: 60000, 60001, 60002
1070 REM
1080 REM - BACKSPACE AND RUBOUT CHARACTER WILL DELETE THE CHARACTER
1090 REM BEFORE THE CURSOR, A CONTROL 'D' ('D') WILL DELETE THE
1100 REM ENTIRE LINE, THE 'RETURN' KEY WILL ACCEPT THE INPUT (ANSWER).
1110 REM
1120 REM
1130 REM - CREATE NULL POINTER

1140 ROPEN 60000
1150 RCLOSE
1160 CURSOR 60000

1170 REM - SAVE CURRENT GRAPHIC CURSOR COORDINATES

1180 INPUT @32,24:X0,Y0

1190 REM - CREATE AND POST PROMPT STRING

1200 HOME
1210 ROPEN 60001
1220 VISIBILITY 60001,0
1230 PRINT Q$;
1240 RCLOSE
1250 STPOINT 60001,X1,Y1
1260 VISIBILITY 60001,1

1270 REM - INITIALIZE ANSWER STRING

1280 A$=""
1290 BLINK 60002,0,0

1300 REM - CREATE AND POST ANSWER STRING

1310 ROPEN 60002
1320 VISIBILITY 60002,0
1330 PRINT "J";A$;"_";

1340 RCLOSE
1350 STPOINT 60002,X1,Y1
1360 VISIBILITY 60002,1

1370 REM - GET CHARACTER INPUT

1380 POINTER X,Y,Z$
1390 IF LEN(Z$)=0 THEN 1540
1400 IF Z$<>"B" AND ASC(Z$)<>127 THEN 1450

1410 REM - BACKSPACE OR RUBOUT

1420 IF LEN(A$)=0 THEN 1380
1430 A$=REP(" ",LEN(A$),1)
1440 GO TO 1290
1450 IF Z$="D" THEN 1280

1460 REM - APPEND CHARACTER TO ANSWER STRING

1470 IF LEN(A$)<L1 THEN 1510
1480 BLINK 60002,0,3,0,3
1490 PRINT "G"
1500 GO TO 1330
1510 A$=A$Z$
1520 GO TO 1310

1530 REM - EXIT

1540 RDELETE 60000
1550 RDELETE 60001
1560 RDELETE 60002
1570 CURSOR 0
1580 PRINT @32,21:X0,Y0
1590 RETURN
```

Method

The POINTER command reads a character at a time from the keyboard. The crosshair cursor is eliminated by defining an empty segment (60000) and attaching it to the cursor (CURSOR 60000). Before returning, the subroutine resets the cursor to the standard crosshairs (CURSOR 0). Segment 60001 displays the prompt. A STPOINT command positions the segment. Segment 60002 displays the response. If the length of the response (A\$) equals the maximum allowable length (L1), then segment 60002 is blinked and the bell rings each time the user attempts to enter another character, until a RETURN is pressed to accept the string, or a BACKSPACE, RUBOUT or D is used to delete characters.

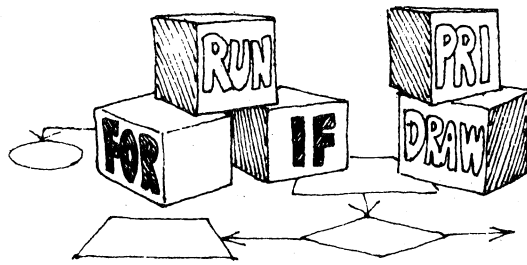

BASIC BITS

Auto number by other than 10

by **Ben Buisman**
Tektronix, Inc.
Wilsonville, OR

will bring line 100 to the screen. Press RETURN and line 125 will be displayed (and any existing lines between 100 and 125).

There's a couple of times you might want to increment the AUTO NUMBER routine by other than the default 10 lines.

or

1, 1

(then press AUTO NUMBER)

1. When you're setting up the User-Definable Keys, you probably want to step the program one line at a time.
2. If you're outlining a program on the 4050 for the first time, you could leave large chunks of program space between lines to fill with details later by AUTO NUMBERing every 50 or 100 lines.

will bring up line 1 and increment the program, each time RETURN is pressed, by one line.

To set the AUTO NUMBER increment to another value, key in the line number you want to begin the program, a space (or comma or other delimiter), then the required increment. Then press AUTO NUMBER.

For example,

100 25

(then press AUTO NUMBER)

Programming Tip Exchange

51/00-0501/0	51/00-6002/0
51/00-0901/0	51/00-8004/0
51/00-1403/0	51/00-8017/0
51/00-1603/0	51/00-8022/0
51/00-4002/0	51/00-9507/0
51/00-5204/0	51/00-9533/0

Send in your programming tip. Any one of the following 4050 Series Applications Library programs* will be yours when it's published. Simply jot down a brief description of the function, the code, and your choice of program. Mail it to the 4050 Series Applications Library serving you; Library addresses are listed at the back of each TEKniques issue.

*Documentation and listing only.



4050 Series Applications Library Program Abstracts

Order

Documentation and program listings of each program are available for a nominal charge. Programs will be put on tape or disk for a small recording fee per program plus the charge for the tape cartridge or flexible disk. One tape/disk will hold several programs. Programs will be recorded on like media only, i.e., programs on tape cannot be sent on disk and vice versa unless so noted in the abstract.

(The program material contained herein is supplied without warranty or representation of any kind. Tektronix, Inc. assumes no responsibility and shall have no liability, consequential or otherwise, or any kind arising from the use of this program material or any part thereof.)

Domestic U.S. Prices:

Documentation and listings \$20 per program
 Recording Fee 5 per program
 Tape Cartridge 30 per tape
 Flexible Disk 15 per disk

Contribute

Contribute one program to the Library and receive three in exchange. Send in the membership card from your 4050 Series Graphic System Reference Manual to get the details. Or call us (503) 685 3618.

Forms

Please use the Applications Library Order Form. Order forms are included in the Membership Packet and are available from your local Tektronix Sales Engineer.

Outside U.S.

Program contributions or orders outside the U.S. must be processed through the local Tektronix sales office or sent to one of the Libraries serving your area. See Library Addresses section.

Correction in Abstract Number

TEKniques Vol. 4 No. 5 carried a new abstract "Drafting Digitizer" by Tom Sutherlin of Cameron University. Unfortunately, the abstract numbers were

transposed. Instead of 51/00-9534/0 it should read.

51/00-9543/0

Please correct it in your copy of TEKniques to preclude any ordering problems.

ABSTRACT #: 51/00-4003/0

Title: **Timer Calculation For Cobalt-60 Treatment Plans**

Author: David H. Robinson
 St. Mary's Hospital
 Waterbury, CT

Memory Requirements: 8K
 Peripherals: 4662 Plotter
 Statements: 153
 Files: 1 ASCII Program

The program allows the user to specify the physical parameters necessary for implementing a completed treatment plan and performs the treatment time calculation for each beam. Data is entered via the keyboard and is then plotted on the treatment plan using the 4662 Plotter.

wedge orientation
 gantry angles
 beam weight
 tray factor

Isocenter Location

The program calculates the treatment time for each beam. All plan parameters are then plotted on the plan. Space is allocated for the user to place an anatomical drawing and indicate the level(s) at which the patient contour was taken.

WARNING

The recipient of this program is solely responsible for verifying the accuracy and appropriateness of this program for his treatment planning system.

```

ENTER THE NUMBER OF FIELDS IN THIS PLAN: 3
ENTER THE NORMALIZATION NUMBER (I.E. 140): 150
ENTER THE TOTAL TUMOR DOSE AT NORMALIZATION LEVEL (RADS): 200

BEAM # 1:
FIELD WIDTH (CM): 8
FIELD LENGTH (CM): 10
EQUIVALENT SQUARE (CM): 8.9
OUTPUT (RADS/MIN AT 80 SSD): 80.8
WEDGE ANGLE (0=OPEN BEAM): 0
WEDGE FACTOR (0=OPEN BEAM): 0
WEDGE ORIENTATION (0=OPEN BEAM, 1=ANT, 2=POST, 3=LT,
4=RT, 5=SUP, 6=INF): 0
GANTRY ANGLE (START): 0
GANTRY ANGLE (STOP): 0
BEAM WEIGHT (I.E. 100): 100
TRAY FACTOR (I.E. 0.98): 1.00
TREATMENT TIME: 1.65 MINUTES

CHANGE DATA FOR BEAM # 1 ?(Y/N):
    
```

User Input:

Plan Description

number of beams
 normalization number
 total tumor dose

Individual Beam Parameters

field width
 field length
 output (RADS/MIN at 80 SSD)
 wedge angle
 wedge factor

TREATMENT TIME CALCULATION

TOTAL DAILY TUMOR DOSE: 200 RADS NORMALIZATION NUMBER: 150

BEAM #	WIDTH	LENGTH	EQSQ	WEDGE ANGLE	WEDGE ORIENT	ACTUAL GANTRY ANGLES	WEIGHT	WEDGE FACTOR	TRAY FACTOR	OUTPUT (RADS/MIN)	TREATMENT TIME(MIN)
1	8.0	10.0	8.9	0	0	0 - 0	100.0	1.00	1.00	80.8	1.65 min.
2	8.0	10.0	8.9	30	1	240 - 240	50.0	0.70	1.00	80.8	1.18 min.
3	8.0	10.0	8.9	30	1	120 - 120	50.0	0.70	1.00	80.8	1.18 min.

ISOCENTER LOCATION:

SUPERIOR/INFERIOR: MOVE 1 CM SUPERIOR TO REFERENCE MARK
 RIGHT/LEFT: ON MIDLINE REFERENCE MARK
 ANTERIOR/POSTERIOR: MOVE 1 CM ANT. TO REF. MARK --- ANT SSD=70.5 CM

CONTOUR LEVEL(S)

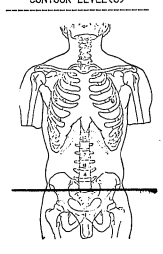

WEDGE ORIENT (THICK):

0=OPEN 1=ANT 2=POST
 3=LT 4=RT
 5=SUP 6=INF

ABSTRACT #: 51/00-5507/0

Title: **SIDAP—Student Interactive Data Analysis Program**

Author: Dr. D.J. Steck
T. Huber
Dept. of Physics
St. John's University
Collegeville, MN

Memory Requirement: 32K
Peripherals: Optional—4641 Printer
4662 Plotter

Statements: 980

Files: 1 ASCII Program

The program helps the user find the "best" functional relationship for a two-dimensional data set that includes experimental uncertainties. The program operates at either a normal or an advanced level. The normal level has seven "standard", two-parameter functions available to fit the data.

1. Linear $Y=A+BX$
2. Power $Y=A X^{\uparrow} B$
3. Exponential $Y=A \text{ EXP}(BX)$
4. Con-expo $Y=A(1-\text{EXP}(-BX))$
5. Nat Log $Y=A+B \text{ LN}(X)$
6. Inverse $Y=A+B/X$
7. Hyperbolic $Y=X/(A+BX)$

Extensive tutorial messages and plots help the user enter data and judge the fit. At the advanced level the program is more versatile and less tutorial. It allows for additional functional forms having up to 5 parameters.

User input:

Experiment Title
Name (user's)
Number of data points to be used (up to 40)
Data points (in the form X,Y)

```

AN ANALYSIS OF DATA FROM THE EXPERIMENT-RADIATION ATTENUATION
CONDUCTED BY: TOM HUBER
INDICATES THAT A FUNCTION OF THE FORM
FORM #3 ** EXPONENTIAL ** Y=A EXP(BX)
WITH CHISQR= 1.1 WHICH MEANS THAT IT HAS A
95% CHANCE OF REPRESENTING THE EXPERIMENTAL DATA AND ERRORS

```

```

WHEN A= 411.1846 +- 10.6356
AND B= -0.1526 +- 0.0822
THE FIT DEVIATIONS(UNITS=ERROR BARS) ARE :

```

POINTS	X	Y	DEVIATION
1	1.00	377.00 +- 26.39	0.9
2	20.00	18.00 +- 1.26	-1.1
3	2.00	316.00 +- 22.12	0.6
4	4.00	226.00 +- 15.82	0.2
5	8.00	113.00 +- 7.91	-1.1
6	16.00	40.00 +- 2.80	1.5
7	10.00	84.00 +- 5.88	-0.9
8	12.00	66.00 +- 4.62	0.0
9	14.00	54.00 +- 3.78	1.4

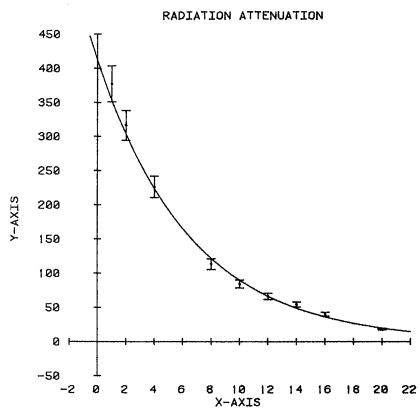

Once an acceptable fit is achieved, the experiment data and table of calculated values may be output to the 4050 screen or a 4641 Printer. A graph of the data and fit may be output to the 4050 screen or the 4662 Plotter. Output to the plotter allows the user to label the X and Y axes, set the graph scale, change pen colors for the axis, data and fit.

Data may be stored on tape in a pre-MARKED data file.

TABLE OF CALCULATED VALUES	
Y-CALCULATED	CURRENT X VALUE
411.184577528	0
352.997857334	1
303.043765006	2
260.159459126	3
223.343793029	4
191.737984118	5
164.60477331	6
141.311235336	7
121.31401071	8
104.146631791	9
89.4086416726	10
76.7562528741	11
65.8943279425	12
56.5694948934	13
48.5642368989	14
41.6918183558	15
35.791928975	16
30.7269442848	17
26.3787153171	18
22.6458125915	19
19.4411601082	20

ABSTRACT #: 51/00-8044/0

Title: **Enhanced Program Listings**

Author: Tim Giesbers
Tektronix, Inc.
Beaverton, OR

Memory Requirement: 8K
Peripherals: Optional—4641 Printer
Statements: 144
Files: 1 ASCII Program

The program will list any ASCII program file, or consecutive files, stored on tape.

The list can be either to the 4050 screen or a 4641 Printer. If the list is to the screen, copies may be made automatically on a 4631 Hard Copy Unit.

The listing includes file numbers and the length of each file is given in bytes at the end of the listing.

Statements inside FOR/NEXT loops are indented, and REM statements are

separated from other program lines by a blank line for emphasis.

New pages are automatic with the user specifying the number of lines per page and the length of the pause between pages. There is no provision for wraparound or truncation of a line which is longer than the width of the printer paper.

User input:

First file number
Last file number
Output device number
Automatic copies Yes/No
How many lines per page
How many seconds of pause

```

ENHANCED PROGRAM LISTINGS

First file to list: 1
Last file to list: 1

Output device (32):
Automatic copies (Y/N):
How many lines per page (32):
How many seconds of pause (2):

```

```

FILE #1
100 REM # ENHANCED PROGRAM LISTINGS #
110 REM
120 REM Tim Giesbers September 6, 1980 Tektronix 4050
130 REM
140 REM This program will read any ASCII program file (or
150 REM consecutive files) and list the program in the file on the
160 REM output device chosen by the user, with emphasis on REM
170 REM statements, and indenting for any statements inside FOR/NEXT
180 REM loops. It can also automatically copy the listing, if it is
190 REM on the screen, and pause for any number of seconds at the
200 REM bottom of each page. At the end of each file listing, the
210 REM length of the program (in bytes) is printed.
220 REM Idea from a program of Dan Toulson's, and from Roger Chan's
230 REM program, "Automatic Hardcopy File Listings", Applications
240 REM Library abstract 851/00-8037/0.
250 REM
260 REM variables:
270 REM A$ - string used to input each line of code from the file(s)
280 REM B - length in bytes of the program in file F
290 REM B$ - answer to Y/N automatic hard copy question
300 REM C - line counter (execute a form feed when C>2L)
310 REM D - device the listing(s) will be printed at
320 REM F - the file we're presently listing (FOR/NEXT loop index)
330 REM I - first file number to list
340 REM F2 - last file number to list
350 REM I - FOR/NEXT loop index
360 REM I1 - FOR/NEXT loop index
370 REM I2 - FOR/NEXT loop index
380 REM IS - spaces for indenting lines that are inside FOR/NEXT loops
390 REM K$ - keyword separated from A$
400 REM L - number of lines to print before doing a form feed

```

4050 Series Applications Libraries

Africa, Europe, Middle East

Contact local sales office

Australia

4050 Series Applications Library
Tektronix Australia Pty. Limited
Sydney
80 Waterloo Road
North Ryde, N.S.W. 2113

Canada

4050 Series Applications Library
Tektronix Canada Ltd.
P.O. Box 6500
Barrie, Ontario
Canada L4M 4V3

Caribbean, Latin America and Far East (excl. Japan)

IDD Group
Export Marketing
Tektronix, Inc.
P.O. Box 500
Beaverton, Oregon 97077
U.S.A.

Japan

4050 Series Applications Library
Sony/Tektronix Corporation
9-31 Kitashinagawa-5
Tokyo 141 Japan

United States

4050 Series Applications Library
Tektronix, Inc.
Group 451
P.O. Box 500
Beaverton, Oregon 97077

Tektronix[®]
COMMITTED TO EXCELLENCE

TEKTRONIX, INC.
Information Display Division
Applications Library
Group 451
P.O. Box 500
Beaverton, Oregon 97077

BULK RATE
U.S. POSTAGE
PAID
TEKTRONIX, INC.

Address Correction Requested — Forwarding and Return Postage Guaranteed.