

CHAPTER 8

TD8-E DECTAPE CONTROL

SECTION 1 INTRODUCTION

The TD8-E Simple DECTape Control is used to control a TU56M or TU56MH Tape Drive Unit (Figure 8-1). The TD8-E controls the assembly and disassembly of data to be read from or written onto the DECTape and provides control signals to the drive unit. The TD8-E logic is on one quad board, Module M868, that is inserted into the PDP-8/E OMNIBUS and connected to a single or dual TU56M Tape Drive by a 7008447 cable.

The TD8-E controls the direction and motion of the tape drive unit with signals generated by flip-flops in the Command Register. The Command Register allows the TD8-E to select even or odd tape drive, start and stop, move forward or reverse, and read or write by changing the state of four flip-flops. These flip-flops are controlled by an instruction (SDLC) that loads the Command Register with four bits of data from the AC.

The assembly and disassembly of the 12 data bits takes place in the Data Register. The Data Register contains the gating and register necessary to receive data from and place data on the OMNIBUS. The Data Register takes serial data from the tape during a read operation and puts serial data on the tape during a write operation.*

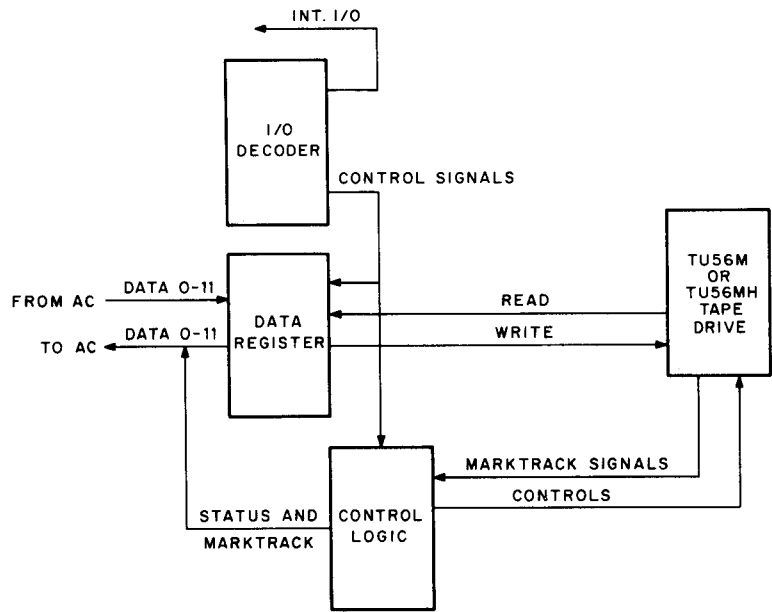

Figure 8-1 TD8-E Block Diagram

*See the *PDP-8/E & PDP-8/M Small Computer Handbook*, page 7-161, for more detailed information on DECTape formatting.

SECTION 2 INSTALLATION

The TD8-E is installed on site by DEC Field Service personnel. The customer should not attempt to unpack, inspect, install, checkout, or service the equipment until a Field Service representative is present.

8.1 INSTALLATION

Perform the following to install the TD8-E System.

Step	Procedure
1	Ensure power is off.
2	Ensure jumpers are installed on the M868 to select the correct I/O code for this TD8-E System (see Table 8-3 for a list of device code jumpers to be installed and unit numbers).
3	Insert the M868 Module into the OMNIBUS (see Volume 1 for module priority).
4	Ensure that the jumpers are installed on the M960 Module (Table 8-2).
5	Connect the 7008447 cable. P3 goes to J1 on the M868 Module and P1 to location A6 or A7 and P2 to location AB10 or AB11 in the TU56M (Table 8-1).
6	Ensure that the G742 Module has been installed in place of the M531 and the G888s are installed in the TU56M Drive Unit.
7	Ensure that the power is wired according to power wiring print TD8-E-3 for the configuration used.

8.2 ACCEPTANCE TEST

Perform the following to check the TD8-E System.

Step	Procedure
1	Run the Formatter Program (DEC-8E-EUZY-D) on each drive. Follow instructions in the formatter document. If testing a TU56M (Dual Drive) swap the formatted tapes from one drive to the other to run the diagnostic test.
NOTE The Formatter will run only on TD8-Es with device code 677X (only on units 0 and 1).	
2	Run the Diagnostic Programs (MAINDEC-08-DHTDA). Refer to the diagnostic document for instructions necessary to run the diagnostic.

8.3 TD8-E INTERFACE

A 7008447 cable is used to interface with the TU56M Tape Transport (Table 8-1). M960 and M961 Connector Modules are used to connect to the TU56M. The M960 Module is used as connector P1 and the M961 Module as connector P2. The M960 Module has unit selection jumpers that must be installed to select the correct unit. Jumpers are installed between split lugs as indicated in Table 8-2 to select the proper unit code for the unit.

Table 8-1
TD8-E Signal Interface





J1 (P3) on TD8-E	Wire Color	Logic on M960 or M961	M960 Module Pin No.	M961 Module Pin No.	Description
NN	Black		M1		Time Mark Enable
MM	Brown		C2		Ground
TT	Red		E1		Reverse
			H1		Forward
SS	Orange		C2		Ground
JJ	Yellow		B1		Stop
			D1		Go
HH	Green		C2		Ground
RR	Blue		J1		Con All Halt
PP	Violet		C2		Ground
LL	Gray				
			0	V2	Unit 0
			1	E2	Unit 1
			2	H2	Unit 2
			3	K2	Unit 3
			4	M2	Unit 4
			5	P2	Unit 5
			6	S2	Unit 6
			7	T2	Unit 7
KK	White		C2		Ground
N	Black		P1		Select Echo
M	Brown		C2		Ground
T	Red		S1		Write Echo
S	Orange		C2		Ground
AA	Black		C2		Ground
BB	Brown			AA1	Write Time
				AB1	Track Pulses
					Write Time
					Track Pulses
EE	Red			AC2	Ground
FF	Orange			AC1	Word 0
				AD1	
H	Yellow			AC2	Ground
J	Green			AK1	Read Time Track
E	Blue			AC2	Ground
F	Violet			AM1	Read Mark Track
W	Gray			AC2	Ground
X	White			AR1	Word 2
				AS1	Word 2
CC	Black			AC2	Ground
DD	Brown			AT1	Word 1
				AV1	Word 1
Y	Red			AC2	Ground
Z	Orange			BA1	Word Enable
K	Yellow			AC2	Ground
L	Green			BB1	Read 1
C	Blue			AC2	Ground
D	Violet			BE1	Read 0
U	Gray			AC2	Ground
V	White			BK1	Read 2

Table 8-2
M960 Module Jumpers

Octal Code	Unit Numbers	Install Select Jumpers
677X	0 and 1	0 and 1
676X	2 and 3	2 and 3
675X	4 and 5	4 and 5
674X	6 and 7	6 and 7

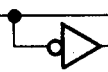
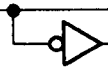
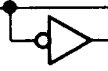
SECTION 3 FUNCTIONAL DESCRIPTION

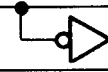
The TD8-E M868 Quad Module is inserted into the OMNIBUS and used to control either the TU56M or TU56MH Tape Drives. The PDP-8/E System can have as many as four TD8-E Modules on the OMNIBUS to control a maximum of 8 tape units (4 dual drive). For each TD8-E System purchased, the user also receives one H716 Power Supply to supply +5 Vdc and - 15 Vdc to the TU56M DEctape. The TU56MH (tabletop model) does not receive the H716 Power Supply.

8.4 INSTRUCTION AND STATUS BITS

The TD8-E uses the following instructions:

Simple DEctape Skip on Single Line Flag (SDSS)

Octal Code: 67X1
Operation: Skip if Single Line flag is set.

Simple DEctape Skip on Time Error (SDST)

Octal Code: 67X2
Operation: Skip if Time Error flag is set.

Simple DEctape Skip on Quad Line Flag (SDSQ)

Octal Code: 67X3
Operation: Skip if Quad Line flag is set.

Simple DEctape Load Command Register (SDLC)

Octal Code: 67X4
Operation: Load Command Register from the AC, clear Time Error, and start UTS Delay if UNIT, DIRECTION or STOP/GO flip-flops are changed.

Simple DEctape Load Data Register (SDLD)

Octal Code: 67X5
Operation: Load Data Register from the AC, do not clear the AC, and clear Single Line and Quad Line flags.

Simple DEctape Read Command Register (SDRC)

Octal Code: 67X6
Operation: Load contents of Command Register, Mark Track Register, and Status bits into the AC. Clear Single Line and Quad Line flags.

Simple DEctape Read Data Register (SDRD)

Octal Code: 67X7
Operation: Load contents of Data Register into the AC, and clear Single Line and Quad Line Flags.

The X in the octal code of the instruction indicates one of four different I/O codes used so that four TD8-E modules can be used on the PDP-8/E OMNIBUS. The I/O codes used are 677X, 676X, 675X, and 674X. The first two TD8-Es ordered will have I/O codes 677X and 676X, respectively. If three or four TD8-Es are ordered, they will have codes 675X and 674X, respectively. The jumpers to be installed to select the correct device code and the unit number to select the correct unit on the TU56M are shown in Table 8-3.

Table 8-3
Device Code Jumpers

Octal Code	Install Select Jumpers	Unit Numbers
677X	W2 and W4	0 or 1
676X	W2 and W3	2 or 3
675X	W1 and W4	4 or 5
674X	W1 and W3	6 or 7

8.5 FUNCTIONAL OPERATION

Figure 8-2 is a functional block diagram of the TD8-E Simple DECTape Control. For discussion purposes the TD8-E is broken into functional groups of logic. Section 4 contains a detailed discussion of each logic group.

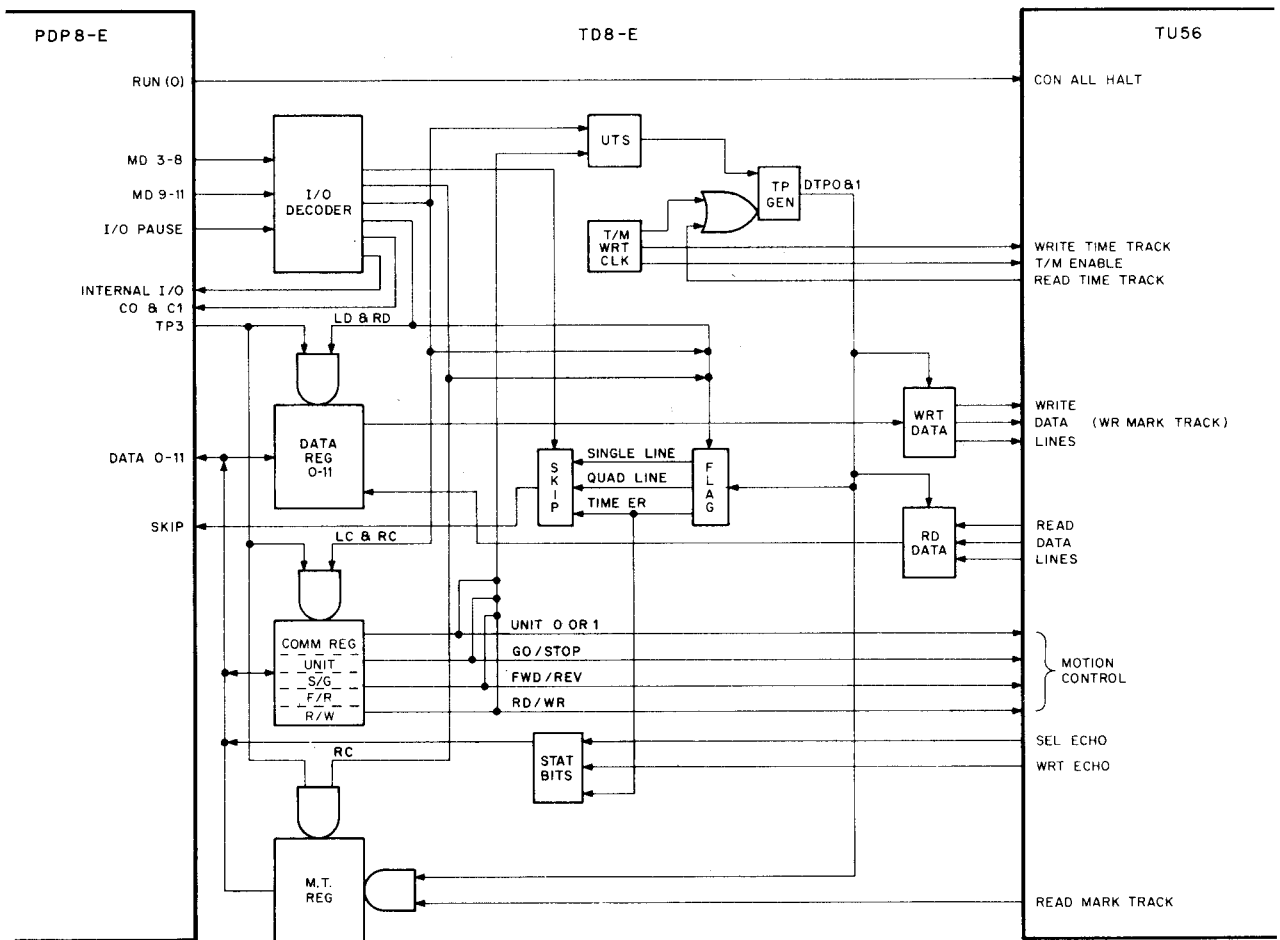

Figure 8-2 TD8-E Functional Block Diagram